

VTRA 2010 FINAL REPORT

Preventing Oil Spills from Large Ships and Barges In Northern Puget Sound & Strait of Juan de Fuca

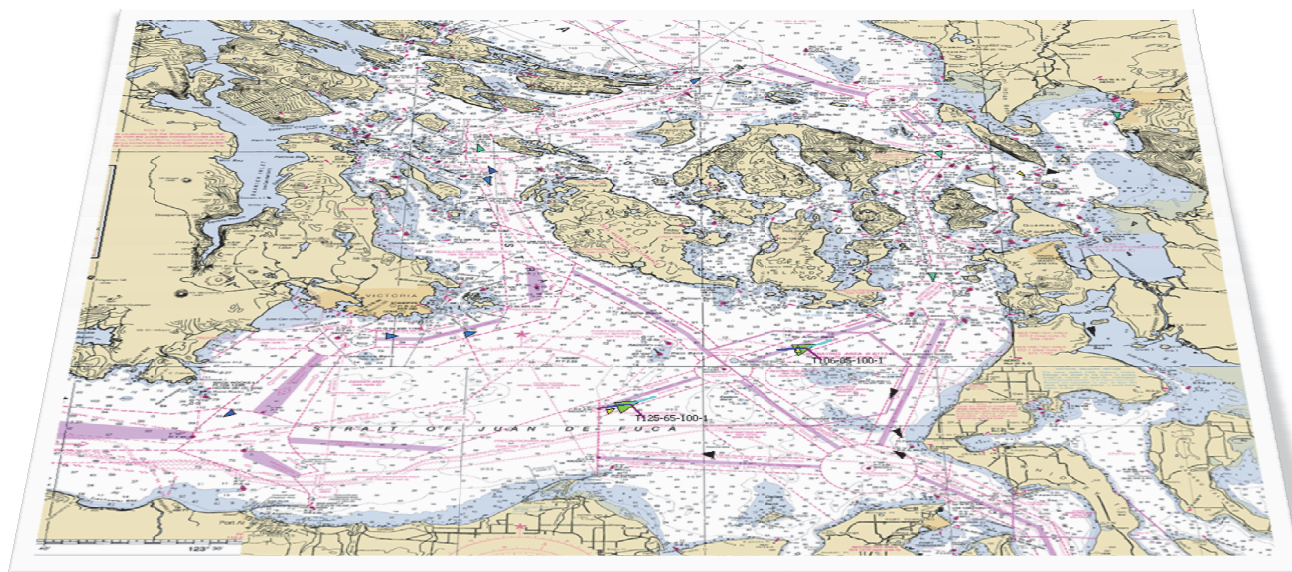

February 2014

THIS PAGE IS LEFT
INTENTIONALLY BLANK

FINAL REPORT: VTRA 2010

Prepared by Author(s):

Dr. Johan Rene Van Dorp
Professor Engineering Management and Systems Engineering
George Washington University (GW)
(202) 994-6638
dorpjr@gwu.edu

Dr. Jason Merrick
Professor Statistical Sciences and Operations Research
Virginia Commonwealth University (VCU)
(804) 828 5865
jrmerric@vcu.edu

Prepared for:

Washington State Puget Sound Partnership

THIS PAGE IS LEFT
INTENTIONALLY BLANK

Final Report

Vessel Traffic Risk Assessment (VTRA):

Preventing Oil Spills from Large Ships and Barges
In Northern Puget Sound & Strait of Juan de Fuca

February 2014

Approved by:

Signature:

Date

Johan Rene Van Dorp, George Washington University

Signature:

Date

Jason Merrick, Virginia Commonwealth University

Signature:

Date

Todd Hass, Contract Manager, Puget Sound Partnership

THIS PAGE IS LEFT
INTENTIONALLY BLANK

Publication Information

This study has been funded in part by the United States Environmental Protection Agency (EPA) through their National Estuary Program, via a grant agreement (#2013-028) with the Puget Sound Partnership (PSP). The study was guided by a VTRA 2010 Steering Committee selected primarily from members of the PSP Oil Spill Workgroup and the Puget Sound Harbor Safety Committee.

The contents of this document do not necessarily reflect the views and policies of the EPA, the PSP, the PSP Oil Spill Workgroup, the Puget Sound Harbor Safety Committee or the VTRA 2010 Steering Committee in particular, nor does mention of trade names or commercial products constitute endorsement or recommendation for use.

Contact Information

Dr. Johan Rene Van Dorp
Professor Engineering Management and Systems Engineering
George Washington University (GW)
(202) 994-6638
dorplr@gwu.edu

Dr. Jason Merrick
Professor Statistical Sciences and Operations Research
Virginia Commonwealth University (VCU)
(804) 828 5865
jrmerric@vcu.edu

Dr. Todd Hass
VTRA Contract Manager
Washington State Puget Sound Partnership (PSP)
(360)280-1588
todd.hass@psp.wa.gov

THIS PAGE IS LEFT
INTENTIONALLY BLANK

PREFACE

This report is submitted by Johan Rene van Dorp (George Washington University) and Jason R.W. Merrick (Virginia Commonwealth University), GW/VCU hereafter. The content of the report describes a vessel traffic risk assessment (VTRA) conducted 2012-2014. To distinguish the study described herein from the previous VTRA study conducted 2006-2008 utilizing 2005 VTOSS data, it will be labeled VTRA 2010. The starting point for the VTRA 2010 analysis is the updated VTRA 2005 model with 2010 VTOSS data, as agreed upon in the scope of work between GW and the PSP. The update of the VTRA 2005 model to using VTOSS 2010 data was separately funded by the Makah Tribal Council [19]. The VTRA study area covers US/Canadian trans-boundary waters including: portions of the Washington outer coast, the Strait of Juan de Fuca and the approaches to and passages through the San Juan Islands, Puget Sound and Haro-Strait/Boundary Pass. The VTRA area is divided in 15 separate waterway zones outlined in Figure 1. This study has been funded in part by the United States Environmental Protection Agency (EPA) through their National Estuary Program, via a grant agreement (#2013-028) with the PSP. The waterway zone analysis results presented in this report was also funded by the Makah Tribal Council.

Both the Puget Sound Partnership (PSP) and the Makah studies utilized the extensive technical work already completed by the George Washington (GW) University and Virginia Commonwealth University (VCU) under previously funded maritime risk assessment (MRA) projects. Specifically, the Prince William Sound Risk Assessment (1996), The Washington State Ferry Risk Assessment (1998), The San Francisco Bay Exposure Assessment (2004) and the 2005 Vessel Traffic Risk Assessment (VTRA 2005). The VTRA 2010 analysis tool evaluates the duration that vessels travel through the VTRA study area, referred to as vessel time exposure (VTE), by vessel type and the potential accident frequency and oil losses from a class of focus vessels. The inclusion of the time on the water element in the evaluation of exposure sets the VTRA 2010 methodology apart from count based approaches that focus on, for example, number of annual/monthly vessel transits, visits or calls. The value of a duration based approach versus a count based approach is that the former appropriately distinguishes between short and long transits in the evaluation of vessel traffic risk as well as differing vessel speeds. The VTRA 2010 methodology has been well documented and peer-reviewed in the academic literature and continuously improved over the course of the above maritime risk assessment projects. A reference list is provided at the end of this document.

From the outset of this project the support from the United States Coast Guard (USCG) District 13, including Sector Puget Sound, and the Puget Sound Harbor Safety Committee (PSHSC) have been unwavering. In particular, Mark Ashley's (USCG), John Veentjer's (Chair of the PSHSC), Del Mackenzie's (Puget Sound Pilots), Mike Moore (Pacific Merchant Shipping Association) and Norm Davis' (Department of Ecology) support have been instrumental in providing the necessary data for this work. The PSHSC generously extended their hospitality to allow GW/VCU to present their progress over the course of this project during their meetings every other month from October 2012 through February 2014. The PSHSC provided GW/VCU a public platform to obtain feedback from and access to the maritime/regulatory/stakeholder community during the VTRA 2005 update and the VTRA 2010. The VTRA 2010 study was guided by a steering committee formed primarily of members from the Puget Sound Partnership Oil Spill Workgroup and the Puget Sound Harbor Safety Committee.

THIS PAGE IS LEFT
INTENTIONALLY BLANK

EXECUTIVE SUMMARY

Vessels transiting the Salish Sea traverse waters bordering numerous communities en route to ports in both the US and Canada. The Salish Sea is a large (over 1000 square miles) and diverse water body physically characterized by passages that are broad and deep, as well as narrow ones that are navigationally challenging with swift currents. In addition, it is a biologically rich ecosystem with significant natural resources these communities depend upon.

The Strait of Juan de Fuca serves as the entrance to these U.S. and Canadian ports and facilities and is transited by approximately 10,000 deep draft vessels annually including arrivals and departures. Additional transits occur internally as vessels shift locations. There are also tug and barge movements, ferry operations, fishing and recreational vessels throughout. The U.S. Coast Guard Vessel Traffic Service (VTS) handles approximately 230,000 transits annually with about 170,000 of those being Washington State Ferries meaning there are more than 50,000 transits other than ferries. The Puget Sound Pilots report nearly 8,000 assignments annually which provide a good metric for how many deep draft vessel movements there are on the U.S. side.

The area includes an International Maritime Organization (IMO) approved Traffic Separation Scheme (TSS) that governs vessel traffic in the system and its approaches. It is actively managed by a joint U.S. - Canadian Cooperative Vessel Traffic Service (CVTS). At the western entrance to the Strait of Juan de Fuca, it includes the extent of Tofino Traffic's radar coverage; approximately 60 miles out to sea, and extends throughout the Puget Sound region north to Vancouver, British Columbia, and south to Tacoma, Washington and Olympia, Washington. Radar is supplemented by Automatic Identification System (AIS) transponders, radio communications and advance notices for arriving vessels.

In terms of major oil spills, defined as over 10,000 gallons in the study area, State of Washington and U.S. Coast Guard records indicate one accident involving a single hull tanker that grounded while anchoring in Port Angeles in 1985 spilling 239,000 gallons of crude oil and two oil barge accidents; one involving a capsizing in the Guemes Channel in January 1988 spilling 70,000 gallons of heavy fuel and an oil barge grounding on December 30, 1994 near Anacortes on a transit from Vancouver, British Columbia resulting in an estimated 26,936 gallons of diesel spilled (spills outside of the study area not included). Even though this area has not experienced major oil spills in the past 20 years or so, the presence of tankers in an ever changing vessel traffic mix places the area at risk for large oil spills. While a previous GW/VCU analysis [2] of this area demonstrated significant risk reduction of oil transportation risk due to existing risk mitigation measures¹, the potential for large oil spills continues to be a prominent public concern heightened by proposed

¹ In [2] a 91.6% reduction in POTENTIAL oil loss was evaluated utilizing the VTRA 2005 model from all Tankers, Articulated Tug Barges (ATB's) and Integrated Tug Barges (ITB's) as a result of the implementation of the one-way zone regime in Rosario Strait, implementation of double hull tankers and the 2005 Escorting Regime.

maritime terminal developments. In this study we focus on the following three (although other ones are under consideration) since these three are in advanced stages of a permitting process:

- (1) The proposed Gateway bulk carrier terminal at Cherry Point, Washington.
- (2) The Trans-Mountain/Kinder Morgan pipeline expansion in Vancouver, BC.
- (3) The coal, grain and container terminal expansions at Delta Port, BC.

The purpose of this vessel traffic risk assessment (VTRA) is to evaluate potential changes in risk in light of above three maritime terminal developments and to inform the State of Washington, the United States Coast Guard and the Puget Sound Harbor Safety Committee on what actions could be taken to mitigate potential increases in oil spill risk from large commercial vessel in the VTRA study area. This study was not designed to measure the effectiveness of risk mitigation measures already in place. This study is also intended to inform tribes, local governments, industry and non-profit groups in Washington State and British Columbia on potential risk management options.

Summarizing, this study was conducted because study sponsors and involved stakeholders want to ensure potential risks of maritime development projects above are better understood so informed decisions could be made about additional risk mitigation measures that would add to the continuous improvement efforts of the past.

Description of Methodology

The VTRA analysis is predominantly based on Vessel Traffic Operational Support System (VTOSS) 2010 data and will therefore be referred to as VTRA 2010 hereafter. Vessel traffic collision and grounding risks are evaluated for tank focus vessels (oil tankers, chemical carriers, oil barges and articulated tug barges) and cargo focus vessels (bulk carriers, container ships and other cargo vessels). The VTRA analysis based on the 2010 VTOSS dataset shall serve as a base case year to compare potential changes in risk as a result of above maritime terminal developments against.

For context it is important to recognize that the base case 2010 VTRA analysis includes a series of risk mitigation measures. In addition to the previously mentioned IMO Traffic Separation Scheme and CVTS, vessels are subject to Port State Control and other vessel inspections regimes in both Canada and the United States to enforce international and federal standards. Pilotage is required in both the U.S. and Canada and pilotage areas are comparable. Tug escorts for laden tankers are required and tugs are used to assist vessels into and out of the berths. Moreover, there are a number of risk mitigation measures that have been put in place internationally, federally and locally over the last several decades including double hulls for tankers, protectively located fuel tanks for non-tank vessels (still being phased in), a Puget Sound Harbor Safety Plan with Standards of Care, the implementation of AIS, a traffic procedure governing vessels transiting Turn Point at the boundary between Haro Strait and Boundary Pass northeast of Victoria, Canada and a one-way zone regime in Rosario Strait. This list is not exhaustive.

The VTRA 2010 study area is defined by the black border in Figure 1 covering US/Canadian trans-boundary waters including: portions of the Washington outer coast, the Strait of Juan de Fuca and the approaches to and passages through the San Juan Islands, Puget Sound and Haro Strait/Boundary Pass. The VTRA 2010 area is divided in 15 separate waterway zones outlined in Figure 1 as well.

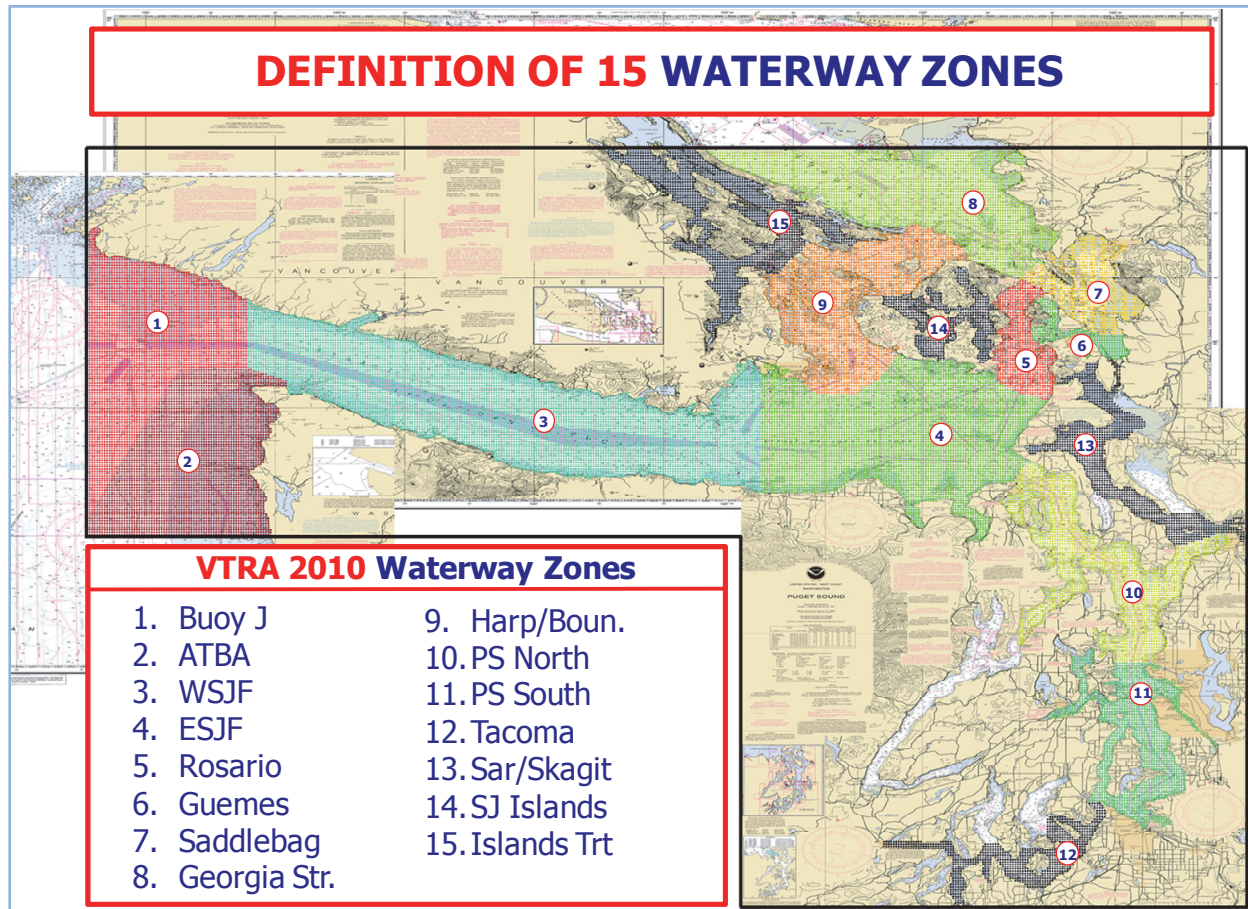

Figure 1. Definition of 15 waterway zones and their descriptors in the VTRA 2010 study area.

The VTRA 2010 methodology has been developed over the course of over ten years of work in various maritime risk assessment projects. Specifically, the Prince William Sound Risk Assessment (1996), The Washington State Ferry Risk Assessment (1998), The San Francisco Bay Exposure Assessment (2004) and the Vessel Traffic Risk Assessment 2005 (VTRA 2005)². The VTRA 2010 analysis methodology has been well documented and peer-reviewed in the academic literature

² The VTRA 2005 analysis in [11] was limited to vessel traffic risk evaluation associated with Tankers, ATB's and ITB's docking at the Cherry Point terminal.

and continuously improved over the course of these MRA projects. A reference list is provided at the end of this document.

This study was guided by a steering committee formed primarily of members from the PSP Oil Spill Workgroup and the Puget Sound Harbor Safety Committee (see Figure 2). The study followed a collaborative analysis approach engaging stakeholders from different constituencies by meeting every other month with the larger Puget Sound Harbor safety committee and in separate afternoon sessions with the VTRA 2010 Steering Committee. Both meetings were open to the public. Afternoon sessions were typically attended by additional stakeholders interested in the progress of this study. An appendix is included with the names of stakeholders that participated during the afternoon sessions one time or another.

Puget Sound Partnership VTRA 2010 Steering Committee

VTRA SC Co-Chairs

- Todd Hass (Puget Sound Partnership)
- John Veentjer (Puget Sound Harbor Safety Committee)

Governmental Leads

- Chip Boothe, Norm Davis, Jon Neel (Department of Ecology)
- CDR Matt Edwards, CAPT Scott Ferguson, LCDR Meridena Kauffman, CDR Kiley Ross, (US Coast Guard, Sector Seattle)
- R.E. McFarland (US Coast Guard, District 13)
- Chad Bowe chop³, Keith Ledford (Makah Nation, Native American Tribes)

Maritime sectors: Core Committee Members (organization)

- Environmental organizations: Fred Felleman³ (Friends of the Earth), Bruce Wishart (Washington Environmental Council)
- Labor: Lori Province (Washington State Labor Council)
- Local government: Mike Doherty³, Lovel Pratt, (WA Association of Counties)
- Petroleum industry: Frank Holmes³ (Western States Petroleum Industry), Ed Irish (Tesoro)
- Pilots: Del Mackenzie³, Jostein Kalvoy, Jonathan Ward (Puget Sound Pilots)
- Steamship lines: Mike Moore (Pacific Merchant Shipping Association)
- Tank vessels: Jeff Shaw (Polar Tankers)
- Tug and barge: George Clark (American Waterways Operators), Mark Homeyer (Crowley)

Figure 2. Organizational Chart of VTRA 2010 Steering Committee.

Our analysis model represents the chain of events that could potentially lead to an oil spill. Figure 3 shows the accident causal chain. We call a situation in which an accident could occur an accident exposure. Maritime Transportation Systems (MTS) have accident exposures from the movement

³ Primary participant attending meetings for organization over course of VTRA 2010 meetings

FINAL REPORT: VTRA 2010

of vessels within it. For each accident exposure, while the vessel is underway, incident and accident probability models are used to calculate the potential accident frequency. This is not a prediction of an accident, but shows a relative propensity that an accident could occur in one situation versus another or the relative propensity for one type of accident versus another. The accident exposure and the potential accident frequency are then combined with an oil outflow model to calculate potential oil loss. Throughout this report we shall use the terminology POTENTIAL to indicate that an accident exposure does not necessarily need to lead to an accident or oil loss, but may.

Our analysis tool evaluates the duration that vessels travel through the VTRA study area (referred to as Vessel Time Exposure, abbreviated VTE), by vessel type. The inclusion of the time on the water element in the evaluation of exposure sets the VTRA 2010 methodology apart from count based approaches that focus on, for example, number of annual/monthly vessel transits, visits or calls. The value of a duration-based approach versus a count-based approach is that the VTE approach appropriately distinguishes between short and long transits in the evaluation of vessel traffic risk as well as high and low vessel speeds.

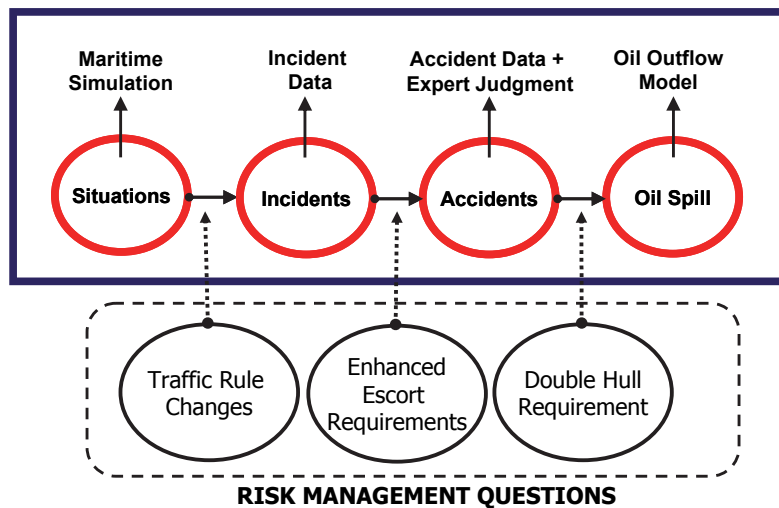

Figure 3. A causal chain of events inter-connected by causal pathways. Risk management questions attempt to block these causal pathways.

Base Case and What-If Results

Figure 4 and Figure 5 are graphical depictions of VTE. For example, Figure 4 and Figure 5 depict that of the total VTE over the 2010 year, 25% (Figure 4) is accounted for by focus vessels and 75% (Figure 5) by non-focus vessels. Non-focus vessels are represented as they can potentially collide with the focus vessel class as well (besides potential collisions amongst focus vessels themselves).

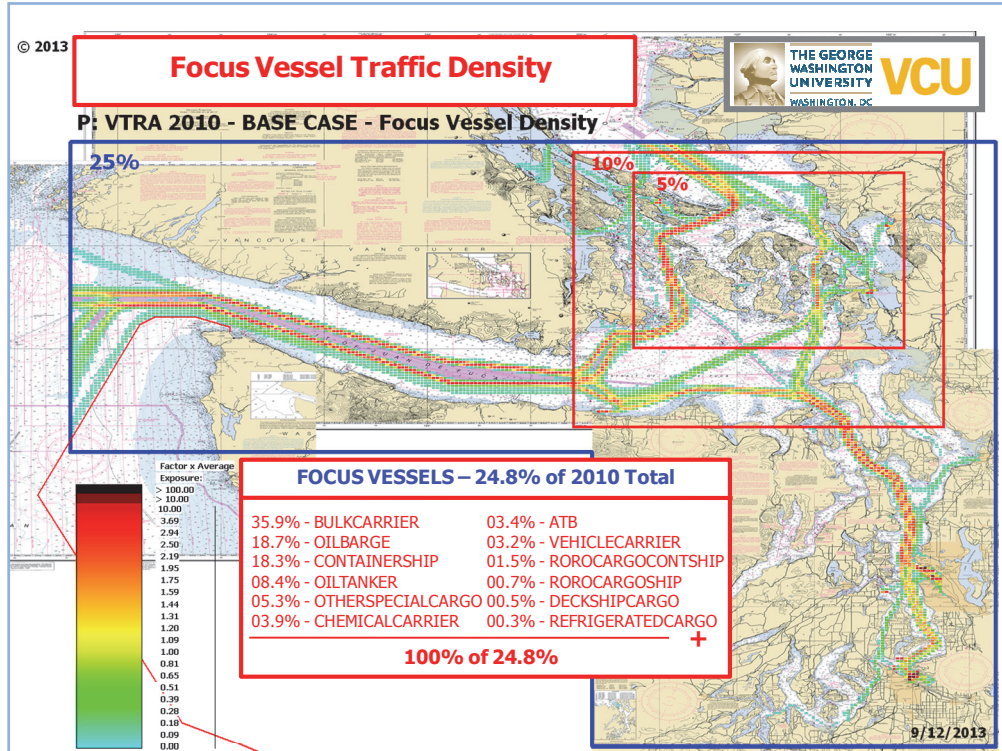

Figure 4. 2D depiction of the traffic density for all focus vessels.

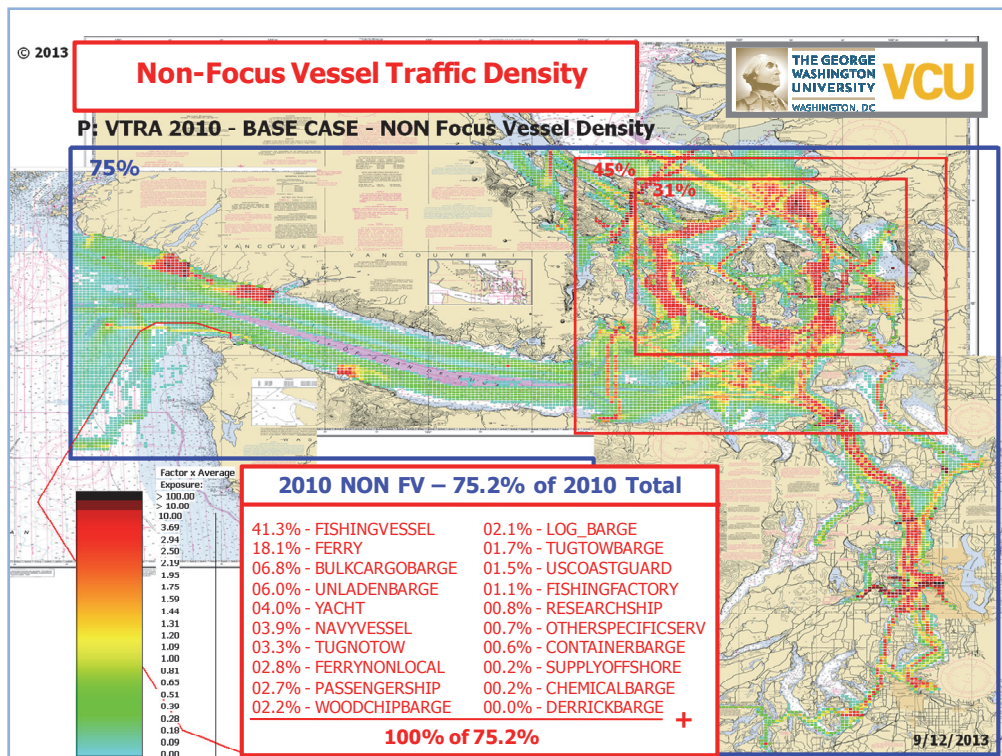

Figure 5. 2D depiction of the traffic density for all non-focus vessels.

FINAL REPORT: VTRA 2010

Figure 5 shows that 41.3% of the non focus vessels VTE are accounted for by fishing vessels, about 18.1% by ferries, about 6.8% by bulk cargo barges, etc.

Approximately nine cargo focus vessels enter and leave Juan de Fuca Strait daily totaling about 6400 transits annually. Similarly, approximately 1400 tank focus vessels travel east and west annually (i.e. about 2 tank focus vessel per day enter and leave in Juan de Fuca Strait 2010). Totaling the VTE for tank focus vessels (Oil barges – 18.7%, Oil Tanker – 8.4%, Chemical Carrier – 3.9%, ATB – 3.4%) we arrive at 34.3% in Figure 4. Hence, about $18.7\%/34.3\% = 54.5\%$ of the total tank focus vessel VTE is accounted for by oil barges that primarily travel within the VTRA study area in a north south direction (see Figure 36 and Figure 37) and therefore many would not be captured as entrance counts to the Strait of Juan de Fuca. Totaling the VTE for cargo focus vessels in Figure 4 we arrive at 65.7%. Therefore:

Finding 1: Within the VTRA 2010 study area about 34.3% of the total time that focus vessels are underway is accounted for by vessels that carry oil products. The remainder 65.7% is attributed to focus vessels that carry other cargo.

Informed by vessel time exposure, the VTRA 2010 analysis tool evaluates POTENTIAL accident frequency and POTENTIAL oil losses for tank focus vessels and cargo focus vessels. The Base Case Scenario (Case P) analysis, based on Vessel Traffic Operational Support System (VTOSS) 2010 data, serves as a reference point to evaluate relative risk changes due to selected potential maritime terminal developments. The Steering Committee chose to model traffic level impacts of maritime terminal development projects that were in advanced stages of a permitting process. Each planned project forms a What-If scenario and associated What-If vessels are added to the 2010 Base Case year, while keeping other traffic levels constant. Specifically, the following What-If Scenario's were suggested for further analysis:

Case Q - GW 487: The Gateway bulk carrier terminal: 487 bulk carriers (318 Panama class and 169 Cape class).

Case R - KM 348: The Trans-Mountain/Kinder Morgan pipeline expansion: 348 crude oil tankers (each 100,000 DWT).

Case S - DP 415: The combination of proposed changes at Delta Port: 348 bulk carriers and 67 container vessels.

Case T - GW-KM-DP: All three of the above scenarios operating at the same time.

Moreover, the Steering Committee recommended that bunkering operations supporting these potential development projects be represented as well in the analysis.

Figure 6 and Figure 7 visualize graphically one of the VTRA 2010 analysis output formats in a manner that hopefully waterway users, regulators and the public can understand. Figure 6 and Figure 7 are 3D visualizations of POTENTIAL oil losses within this study area and their

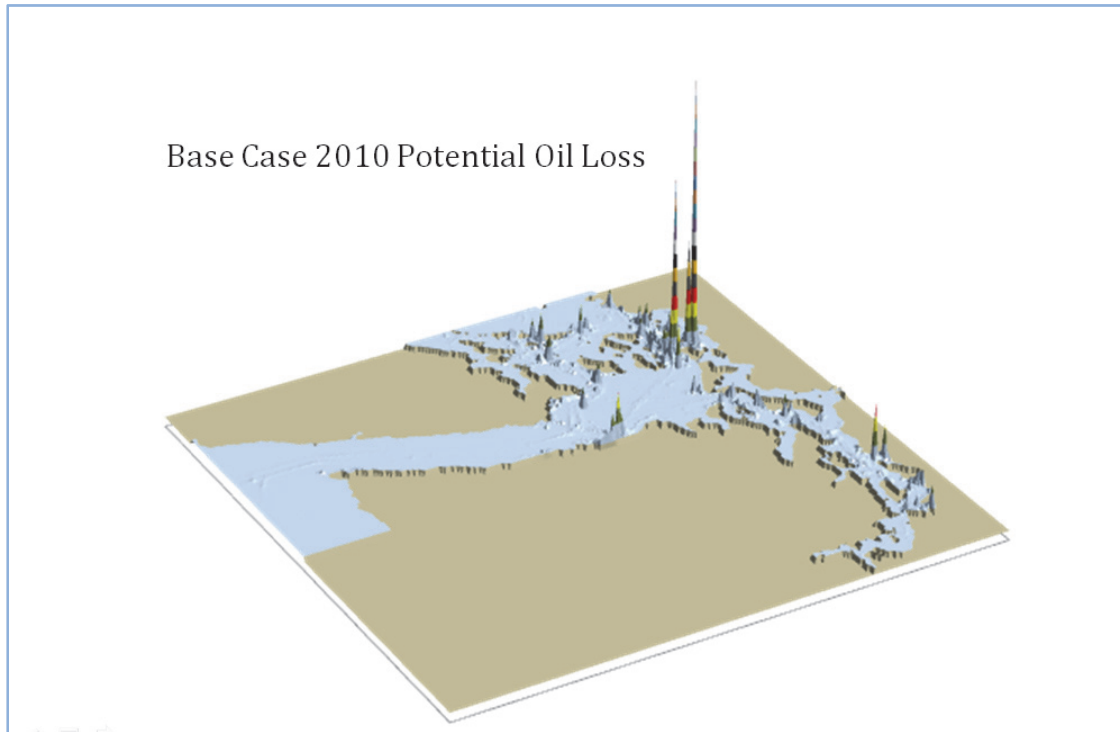

Figure 6. 3D Geographic profile of Base Case 2010 POTENTIAL oil loss (Case P).

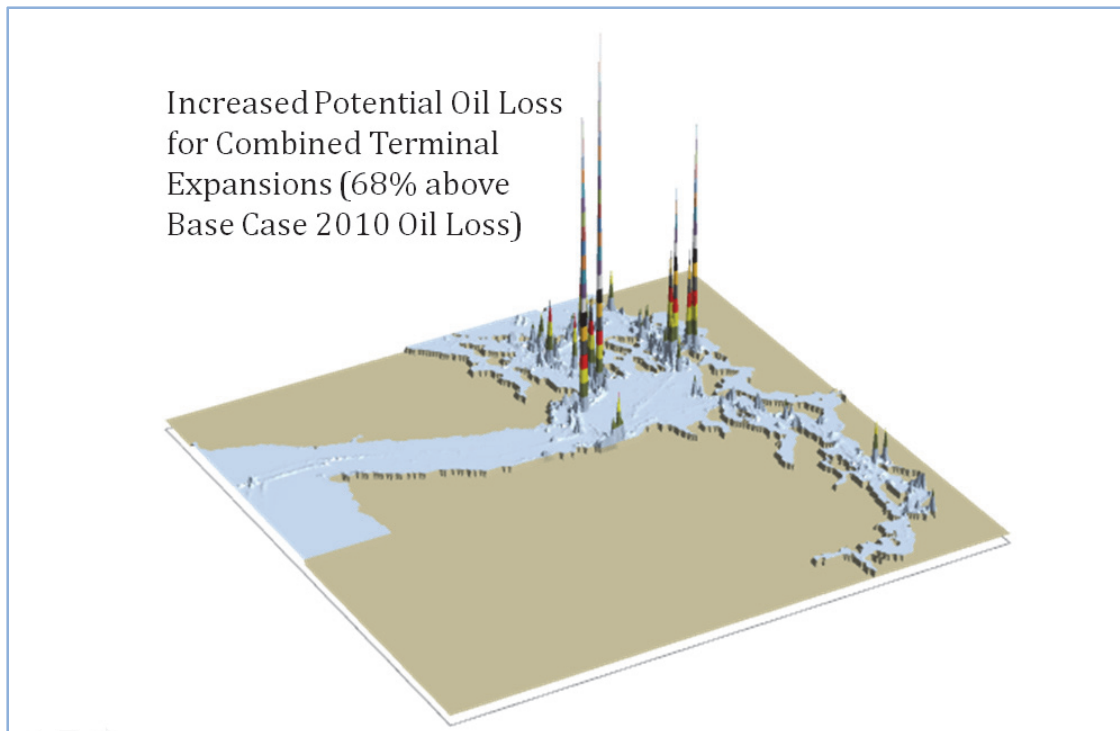

Figure 7. 3D Geographic profile of POTENTIAL oil loss assuming all three What-If Scenarios are operational (Case T).

FINAL REPORT: VTRA 2010

geographic distribution. Figure 6 depicts POTENTIAL oil losses for the 2010 Base Case Year (Case P), whereas Figure 7 depicts POTENTIAL oil losses when all three What-If scenarios are assumed operational at the same time (Case T). Figure 7 illustrates a 1.68 factor increase in overall POTENTIAL oil losses compared to the base case 2010 year without additional risk mitigation. This too demonstrates that throughout the VTRA 2010 we concentrate more on relative comparisons across accident types, oil outflow categories, What-If scenarios and waterway zones and less on the absolute values of the analysis results in our scenario analyses.

For each what-if scenario and each waterway zone we evaluate the total annual focus vessel time of exposure (VTE) for each focus vessel type and compare it to their vessel time of exposure observed in the Base Case 2010 year. Similarly, we evaluate the total oil time exposure (i.e. the total amount of time a cubic meter of oil is moving through the area) for each what-if scenario, taking into account focus vessel fuel and oil cargo, and compare it to the oil time exposure (OTE) observed for the 2010 Base Case year.

The VTE tends to be a driver in the analysis of POTENTIAL accident frequency, whereas the OTE tends to be a driver in the analysis of POTENTIAL oil losses. Figure 8 demonstrates a comparison by waterway zone of the POTENTIAL oil losses for the combined what-if scenario (Case T) to those in the Base Case 2010 year (Case P). A detailed explanation of the output format in Figure 8 is provided in the body of this report on Page 97. Figure 8 shows that while system-wide POTENTIAL oil losses increase by about +68% (1.68) in Case T (green highlight), larger percentages are observed for the following specific waterway zones (Orange and Red highlights):

- Haro Strait/Boundary pass (+375%),
- Buoy J (+344%)
- San Juan Islands (+189%)
- East Strait of Juan de Fuca (+142%),
- West Strait of Juan de Fuca (+104%),
- Georgia Strait (+81%),

Most notably:

Finding 2: The Haro Strait/ Boundary pass and the Buoy J waterway zone specific relative increases in POTENTIAL oil loss are larger than 300% (Red highlights) when all three maritime terminal developments are assumed operational simultaneously. Despite Haro Strait/ Boundary pass and the Buoy J absolute contributions to system-wide POTENTIAL oil losses differing substantially in magnitude, relative changes in both waterway zones deserve further consideration. Be mindful that of the three maritime terminal development projects only the Trans-Mountain/Kinder Morgan expansion involves tankers.

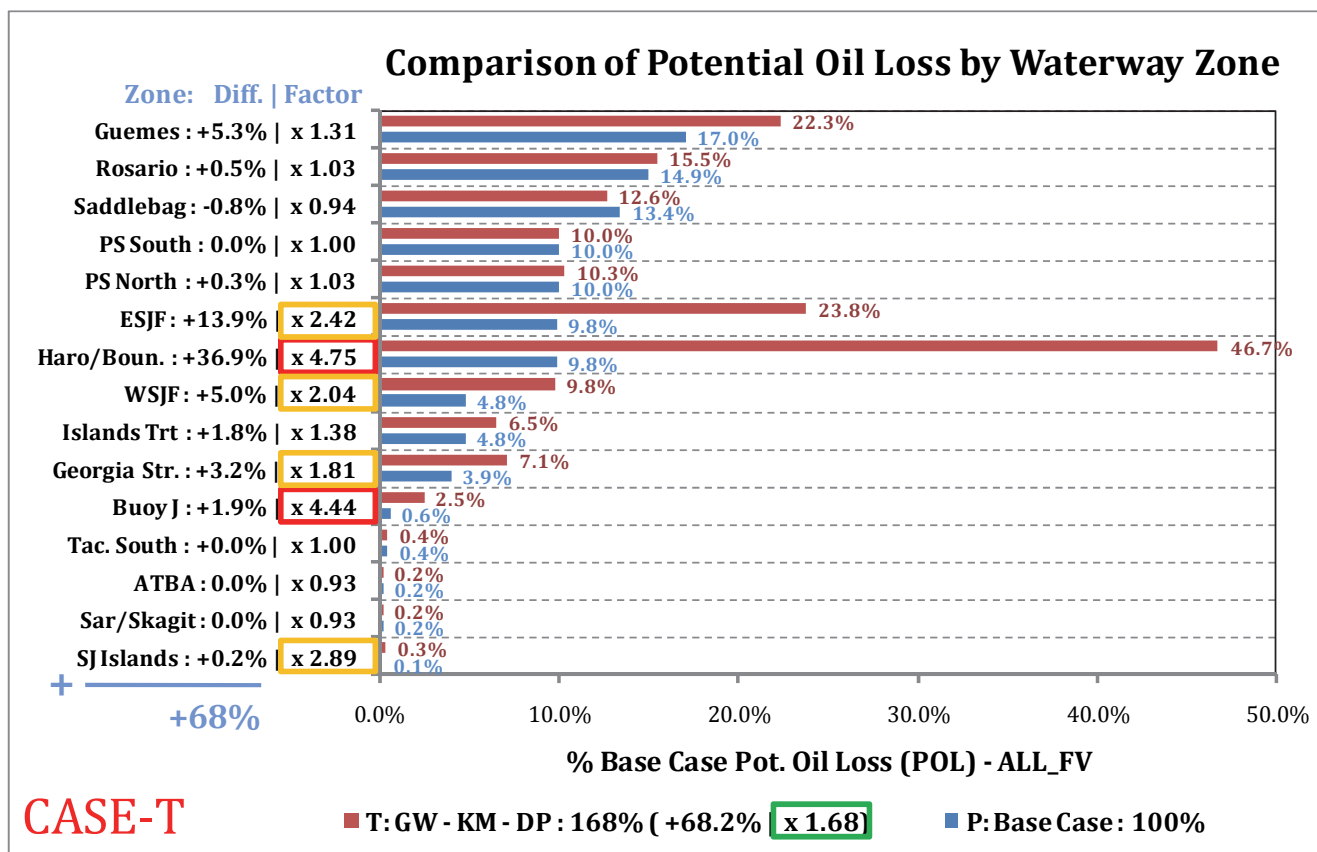

Figure 8. Relative comparison of POTENTIAL oil outflow by waterway zone. Blue bars show the percentage by waterway zone for the base case 2010 year, red bars show the percentage for Case T in terms of base case percentages. Absolute differences by waterway zone and relative multipliers by waterway zone are provided in the y-axis labels. (see Page 97 for detailed explanation of output format).

Risk Mitigation and Historical Bench Mark results

A series of risk mitigation measures were proposed to help inform a risk management process. Table 1 provides descriptions of the scenarios analyzed. The effect of risk mitigation measures were applied to VTRA 2010 model's input parameters and the system-wide and waterway zone specific relative effectiveness of these measures were evaluated. Detailed analysis result presentations by waterway zone for What-If and Risk Mitigation Measure (RMM) scenarios are posted at the following url:

http://www.seas.gwu.edu/~dorpir/tab4/publications_VTRA_Update.html.

We strongly encourage interested parties to visit the url above and study these results to help inform stakeholders when engaging in such a risk management process. In Table 2 the system-wide analysis results for the various scenarios listed in Table 1 are provided on pages 18 and 19.

FINAL REPORT: VTRA 2010

Historical arrival data of tank and cargo focus vessels was obtained from the Marine Exchange of Puget Sound (MXPS). Tank focus vessel arrival data spanned 1998-2012. Cargo vessel Automatic Independent System (AIS) crossing line count data spanned 2008 – 2012 for crossing lines at the entrance to the West Strait of Juan de Fuca, Puget Sound and Georgia-Strait (see Figure 104 on page 137 for a depiction and general location of these crossing lines). Prior to 2008, AIS was either not available or not considered reliable for use herein. An analysis was conducted on both datasets (described in more detail in Chapter 9) and high and low years were selected from both data sets for benchmarking/ sensitivity analysis. High/Low years were used to define High/Low traffic scenarios by adding/canceling vessel transits to/from the 2010 Base Case (P) and the combined What-If Scenario (T).

The purpose of benchmarking/sensitivity analysis is three-fold. First, to evaluate robustness of the 2010 Base Case (P) and Combined What-If (T) Scenario analyses in light of historical increases or decreases in traffic. Second, the high-low scenario analyses conducted on the Base Case (P) serve as a benchmark to compare (1) changes in risk levels evaluated for the various What-If and RMM Scenarios against (2) changes in risk levels evaluated at historical high/low traffic levels. Third, it provides context regarding changes occurring in the background that in conjunction with What-If Scenarios further inform the potential need for risk management actions. Analysis results for the Bench Marking/Sensitivity Scenarios are included in Table 2 as well.

Table 2 shows (orange highlights) that from a tank focus vessel perspective, the high year adds about 2% of tank focus vessel VTE, whereas the low year removes about 2% of tank focus vessel VTE. Moreover, the blue highlights in Table 2 depict that in a high year for cargo focus vessels about $7\% - 2\% = 5\%$ of focus vessel VTE is added, whereas in the low year only $3\% - 2\% = 1\%$ of focus vessel time VTE is removed. Therefore:

Finding 3: The VTRA 2010 Base Case (Case P) is from a historical perspective an average year in terms of tank focus vessel exposure and a rather low year in terms of cargo focus vessel exposure.

Table 2 also lists POTENTIAL changes in risk from the Base Case 2010 year for the three individual What-If and High/Low Scenarios. By and large changes in risk evaluated for the What-If Scenarios exceed those for the high-year bench mark/sensitivity scenario. With the exception of the Delta Port What-If Scenario this observation applies to vessel time exposure, POTENTIAL accident frequency and POTENTIAL oil loss. For the Delta Port What-If Scenario this observation only applies to POTENTIAL accident frequency. Therefore:

Finding 4: Were any of the three individual maritime terminal developments to come into effect, or any combination thereof, POTENTIAL changes in risk may be deemed significant changes from the Base Case 2010 year risk levels. It would thus only be prudent to consider

the implementation of one or more risk mitigation measures to counter those POTENTIAL risk increases.

Eleven Risk Mitigation Measure (RMM) scenarios were evaluated for their potential effectiveness. For 9 out of the 11 RMM scenario's evaluated risk reductions were larger than the risk reductions evaluated for the low year Bench Mark/Sensitivity scenarios enacted on the Base Case 2010 year. Therefore:

Finding 5: For 9 out of the 11 RMM scenarios evaluated, their risk reductions may be deemed significant reductions. Hence it is suggested that their associated risk mitigation measures be considered for implementation, should any of three individual maritime terminal projects, or any combination thereof, to come into effect.

One of the challenges of exercising risk management over a large and complex waterway is being cognizant of both waterway zone specific and system-wide effects. One approach could be to evenly distribute potential risk increases across the affected area, i.e. to allow for risk increases in locations that currently have low risk levels compared to those that are already higher. On the other hand, one could aim for an equitable distribution of future risk allowing for each location to have a similar relative percentage increase in risk.

Following either approach, we believe that the question "which risk mitigation measure should one implement?" is not the right question to ask, but rather one should ask oneself "which portfolio of risk mitigation measures should one implement". A trial 6 RMM portfolio scenario analysis was conducted which resulted in a by enlarge across the board risk reduction across the various waterway zones considered in the VTRA study area (see Figure 9 and Figure 10). Most notably, evaluated overall risk reduction in POTENTIAL accident frequency (-29%) for the trial 6 RMM portfolio applied to the Combined What-If Scenario (T) resulted in lower POTENTIAL accident frequency (89%) than evaluated for the 2010 Base Case (P) POTENTIAL (green high lights in Figure 9 and Table 2). Evaluated POTENTIAL oil losses for the trial 6 RMM portfolio applied to the Combined What-If Scenario (T), on the other hand, were still higher (124%) than the Base Case 2010 year (red high lights in Figure 10 and Table 2). Some caution is needed in interpreting the -29% risk reduction in POTENTIAL accident frequency in the green high light in Figure 9 and the -44% risk reduction in the red high light in Figure 10, as some of the risk mitigation measures efficiency in the 6 RMM trial portfolio are evaluated as maximum potential benefit analyses. Regardless, we arrive at the following conclusion:

Finding 6: While evaluated POTENTIAL risk increases as a result of the three maritime developments may be deemed significant, the VTRA 2010 analysis supports that most of those system-wide risk increases may be mitigated utilizing a well designed RMM portfolio.

In testament to the Puget Sound Harbor Safety Committee stated objective of instilling a safety culture within the Puget Sound maritime community, 4 out of the 11 suggested RMM scenario's

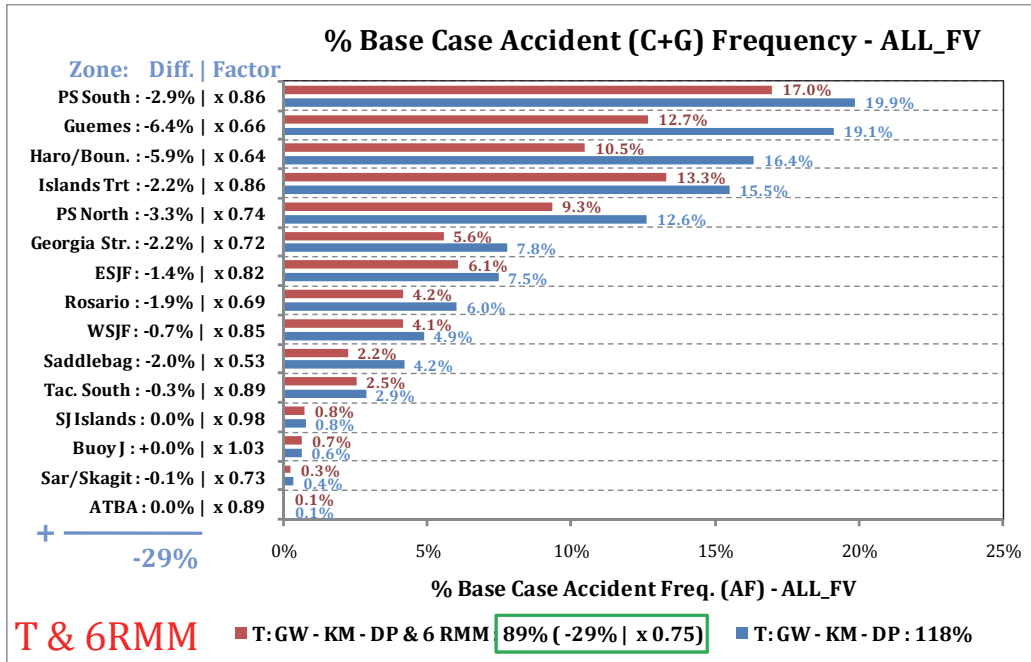

Figure 9. By waterway zone comparison of POTENTIAL accident frequency before and after modeled implementation of a risk mitigation measure port folio enacted on the combined What-If Scenario (Case T). See Page 97 for detailed explanation of output format.

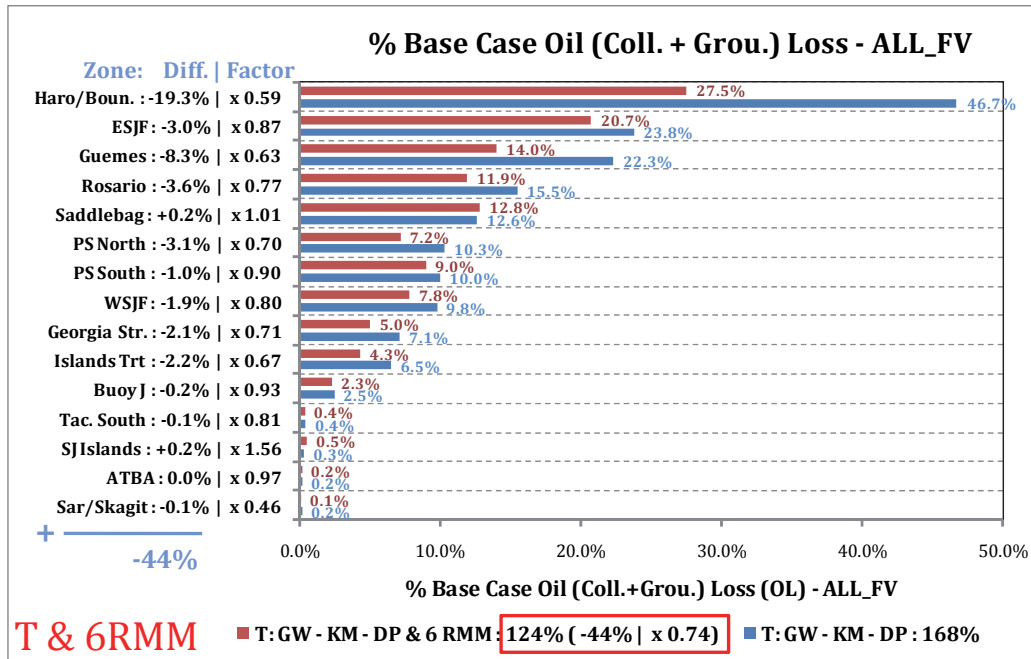

Figure 10. By waterway zone comparison of POTENTIAL oil loss before and after modeled implementation of a risk mitigation measure port folio enacted on the combined What-If Scenario (Case T). See Page 97 for detailed explanation of output format.

FINAL REPORT: VTRA 2010

involved risk mitigation measures that are currently under consideration or have been partially implemented. The evaluation of these RMM Scenarios was applied to the 2010 Base Case year. Subsequent analyses evaluated risk reductions for these RMM scenarios that exceed risk reduction in risk evaluated for the historical low year scenario. Hence:

Finding 7: Even if none of the three individual maritime terminal developments were to come into effect, it is recommended that the risk mitigation measures applied to the 2010 Base Case Scenario be considered for system-wide implementation in the VTRA study area.

Closing Comments

By providing analyses by waterway zone similar to the one depicted in Figure 8 for the various RMM scenario analyses, an information source is provided to help answer difficult and location specific risk management questions. In our opinion, given the number of communities involved in these waterway zones, these risk management questions can only be answered utilizing the collaborative analysis approach. No doubt, these risk management questions are equally important in other ongoing studies considering the potential risk increases as a result of traffic increases linked to proposed maritime terminal development projects.

We close with the observation that there is a serious need for an electronic data source that is cross-boundary (US and Canadian waters) where the vessel type is consistently defined and verified beyond cargo focus vessel or tank focus vessel classifications. VTOSS and AIS are such cross-boundary data sources and could serve this purpose. However without currently possessing a common and consistently recorded vessel identifier or vessel type classification, VTOSS and AIS unfortunately still required vetting at the individual vessel level for the purpose of the analysis presented in this report. Moreover, with the same eye towards risk management analysis it would be equally beneficial if such datasets records capture cargo or at a minimum cargo levels (laden, unladen, 50% laden, etc.) and a cargo type. In particular, we would like to specifically call out the need for the electronic recording at a much greater consistency of the barge type and cargo content of tug-tows. Not only would studies like these benefit from the availability of such a data source, but the immediacy of having such information available could also benefit first responders responding to a spill scenario both from a response and a safety to the first responder perspective.

Summarizing, we advocate a collaborative systems approach towards answering risk management questions, not one that is just locally targeted missing potential side effects or points of view. Ultimately, we believe that the strength of the VTRA 2010 analysis lies in this systems view, but equally important is the evaluation of relative POTENTIAL risk changes of What-If and RMM scenarios within in a single common framework. No doubt, the risk communication process amongst stakeholders that took place following the collaborative analysis approach in conducting these analyses during the VTRA 2010 and made possible by the Puget Sound Harbor Safety Committee is at least as important.

THIS PAGE IS LEFT
INTENTIONALLY BLANK

FINAL REPORT: VTRA 2010

Table 1. Short description of scenario analyses conducted utilizing the VTRA 2010 model

WHAT IF SCENARIO ANALYSIS	
P - Base Case: 2010	Modeled Base Case 2010 year informed by VTOSS 2010 data amongst other sources.
Q - GW - 487 : Gateway	Gateway expansion scenario with 487 additional bulk carriers and bunkering support
R - KM - 348: Kinder Morgan	Transmountain pipeline expansion with additional 348 tankers and bunkering support
S - DP - 415: Delta Port	Delta Port Expansion with additional 348 bulk carriers and 67 container vessels
T - GW - KM - DP: All Three	Combined expansion scenario of above three expansion scenarios
P - Base Case: 2010 - RISK MITIGATION MEASURE (RMM) ANALYSIS	
P - Base Case & DH100	Base Case year with 100% double hull fuel tank protection for Cargo Focus Vessels
P - Base Case & HE00	Base Case Year with 100% human error reduction on Oil Barges
P - Base Case & HE50	Base Case Year with 50% human error reduction on Oil Barges
P - Base Case & CONT17KNTS	Base Case Year with max speed of 17 knots for container ships
Q - GW - 487 : Gateway - RISK MITIGATION MEASURE (RMM) ANALYSIS	
Q - GW 487 & NB	Gateway expansion scenario and no bunkering support
Q - GW 487 & NB & OH	Gateway expansion scenario and no bunkering support and traversing only Haro routes
T - GW - KM - DP: All Three - RISK MITIGATION MEASURE (RMM) ANALYSIS	
T - GW - KM - DP & OW ATB	Case T with ATB's adhering to one way Rosario traffic regime
T - GW - KM - DP & EC	Case T with Cape Class bulk carrier given benefit of+ 1 escort on Haro and Rosario routes
T - GW - KM - DP & EH	Case T with all Focus Vessels given benefit of +1 escort vessel on Haro routes
T - GW - KM - DP & ER	Case T with Cape bulkers, laden Tankers, ATB's given benefit of +1 esc. on Rosario routes
T - GW - KM - DP & 6RMM	Case T with benefit OW ATB, EH, ER, P-HE50, Q-NB and P-CONT17 KNTS
P - Base Case: 2010 - BENCHMARK (BM) & SENSITIVITY ANALYSIS	
P - Base Case & LOW TAN + CFV	Base Case with Tankers and Cargo Focus Vessels set at a low historical year
P - Base Case & LOW TAN	Base Case with Tankers set at a low historical year
P - Base Case & HIGH TAN	Base Case with Tankers set at a high historical year
P - Base Case & HIGH TAN + CFV	Base Case with Tankers and Cargo Focus Vessels set at a high historical year
T - GW - KM - DP: All Three - BENCHMARK (BM) & SENSITIVITY ANALYSIS	
T - GW - KM - DP & LOW TAN + CFV	Case T with Tankers and Cargo Focus Vessels set at a low historical year
T - GW - KM - DP & LOW TAN FV	Case T with Tankers set at a low historical year
T - GW - KM - DP & VAR	Case T with additional variability in timing of What-If Focus Vessel arrivals
T - GW - KM - DP & HIGH TAN FV	Case T with Tankers set at a high historical year
T - GW - KM - DP & HIGH TAN + CFV	Case T with Tankers and Cargo Focus Vessels set at a high historical year

FINAL REPORT: VTRA 2010

Table 2. Summary of VTRA 2010 system-wide scenario analyses results. Detailed analyses results by waterway zone are dispersed throughout this report and available at: http://www.seas.gwu.edu/~dorpjr/tab4/publications_VTRA_Update.html

WHAT IF SCENARIO ANALYSIS				
	Vessel Time Exposure (VTE)	Oil Time Exposure (OTE)	Pot. Accident Frequency (PAF)	Pot. Oil Loss (POL)
P - Base Case: 2010	100%	100%	100%	100%
Q - GW - 487 : Gateway	+13% 113%	+5% 105%	+12% 112%	+12% 112%
R - KM - 348: Kinder Morgan	+7% 107%	+51% 151%	+5% 105%	+36% 136%
S - DP - 415: Delta Port	+5% 105%	+3% 103%	+6% 106%	+4% 104%
T - GW - KM - DP: All Three	+25% 125%	+59% 159%	+18% 118%	+68% 168%
P - Base Case: 2010 - RISK MITIGATION MEASURE (RMM) ANALYSIS				
	Vessel Time Exposure (VTE)	Oil Time Exposure (OTE)	Pot. Accident Frequency (PAF)	Pot. Oil Loss (POL)
P - Base Case: 2010	100%	100%	100%	100%
P - Base Case & DH100	0% 100%	0% 100%	0% 100%	-8% 92%
P - Base Case & HE00	0% 100%	0% 100%	-16% 84%	-4% 96%
P - Base Case & HE50	0% 100%	0% 100%	-8% 92%	-2% 98%
P - Base Case & CONT17KNTS	+4% 104%	+3% 103%	-4% 96%	-6% 94%
Q - GW - 487 : Gateway - RISK MITIGATION MEASURE (RMM) ANALYSIS				
	Vessel Time Exposure (VTE)	Oil Time Exposure (OTE)	Pot. Accident Frequency (PAF)	Pot. Oil Loss (POL)
Q - GW - 487 : Gateway	+13% 113%	+5% 105%	+12% 112%	+12% 112%
Q - GW 487 & NB	-5% 108%	-1% 104%	-1% 111%	-10% 103%
Q - GW 487 & NB & OH	-4% 109%	-2% 104%	-2% 110%	-7% 105%
T - GW - KM - DP: All Three - RISK MITIGATION MEASURE (RMM) ANALYSIS				
	Vessel Time Exposure (VTE)	Oil Time Exposure (OTE)	Pot. Accident Frequency (PAF)	Pot. Oil Loss (POL)
T - GW-KM-DP: All Three	+25% 125%	+59% 159%	+18% 118%	+68% 168%
T - GW - KM - DP & OW ATB	+4% 128%	+4% 163%	-29% 89%	-44% 123%
T - GW - KM - DP & EC	+1% 126%	+2% 161%	0% 118%	0% 168%
T - GW - KM - DP & EH	0% 125%	+0% 159%	-2% 116%	-4% 164%
T - GW - KM - DP & ER	0% 125%	+0% 159%	-7% 111%	-24% 143%
T - GW - KM - DP & 6RMM	0% 125%	+0% 159%	-8% 111%	-12% 156%
P - Base Case: 2010 - BENCHMARK (BM) & SENSITIVITY ANALYSIS				
	Vessel Time Exposure (VTE)	Oil Time Exposure (OTE)	Pot. Accident Frequency (PAF)	Pot. Oil Loss (POL)
P - Base Case: 2010	100%	100%	100%	100%
P - Base Case & LOW TAN + CFV	-3% 97%	-14% 86%	-5% 95%	-20% 80%
P - Base Case & LOW TAN	-2% 98%	-13% 87%	-4% 96%	-22% 78%
P - Base Case & HIGH TAN	+2% 102%	+14% 114%	+3% 103%	+9% 109%
P - Base Case & HIGH TAN + CFV	+7% 107%	+15% 115%	+4% 104%	+8% 108%
T - GW - KM - DP: All Three - BENCHMARK (BM) & SENSITIVITY ANALYSIS				
	Vessel Time Exposure (VTE)	Oil Time Exposure (OTE)	Pot. Accident Frequency (PAF)	Pot. Oil Loss (POL)
T - GW-KM-DP: All Three	+25% 125%	+59% 159%	+18% 118%	+68% 168%
T - GW - KM - DP & LOW TAN + CFV	-3% 121%	-15% 144%	-2% 116%	-27% 141%
T - GW - KM - DP & LOW TAN FV	-2% 123%	-13% 146%	-3% 116%	-23% 145%
T - GW - KM - DP & VAR	-1% 124%	-7% 152%	-3% 116%	-11% 157%
T - GW - KM - DP & HIGH TAN FV	+3% 128%	+15% 174%	+6% 125%	+8% 175%
T - GW - KM - DP & HIGH TAN + CFV	+6% 131%	+16% 174%	+8% 127%	+17% 184%

THIS PAGE IS LEFT
INTENTIONALLY BLANK

FINAL REPORT: VTRA 2010

Table Contents

Publication Information	vii
Contact Information	vii
PREFACE	1
EXECUTIVE SUMMARY	3
Description of Methodology.....	4
Base Case and What-If Results.....	7
Risk Mitigation and Historical Bench Mark results	12
Closing Comments.....	16
Table of Tables.....	23
Table of Figures.....	25
1. INTRODUCTION	30
2. SUMMARY 2005 VTRA MODEL METHODOLOGY.....	36
Situations (see Figure 3):	38
Incidents & Accidents (see Figure 3):.....	41
Oil Spill (see Figure 3):.....	41
Format of Scenario Analysis Results and Comparisons (See Figure 18)	44
Sensitivity and Uncertainty of Analysis Results.....	45
3. UPDATING THE 2005 VTRA GW/VCU Model USING VTOSS 2010 DATA	47
Algorithmic cleaning of VTOSS 2010 data.....	49
Manual cleaning of VTOSS 2010 data	51
Vessel master type definition.....	55
Comparing representative routes approach to the route segment approach	57
Moving from Sampled Speeds to Calculated Speeds.....	59
Extending VTRA 2005 incident and accident probability models	61
Oil carrying assumptions for focus vessels	63
4. VALIDATION OF 2010 VTOSS AND AIS 2010 CROSSING LINE DATA	67
Crossing line analysis of AIS 2010 data	68
Matching VTOSS 2010 Vessel Types to AIS 2010 Vessel Types.....	69
Comparing VTOSS 2010 crossing line counts to AIS 2010 crossing line counts.....	70
5. TRAFFIC PATTERNS AND OIL MOVEMENTS INVTRA 2010 BASE CASE	73
Vessel Time of Exposure (VTE)	76
Oil Time of Exposure (OTE)	76
Traffic Densities Profiles	78
Oil Movement Density	78
6. ACCIDENT FREQUENCY AND OIL OUTFLOW RESULTS FOR VTRA 2010 BASE CASE	81
Overall Accident and Oil Outflow Results.....	81
Accident and Oil Outflow Results by Focus Vessel Type.....	82
Geographic Profiles of Accident and Oil Outflow Results	84

FINAL REPORT: VTRA 2010

7. WHAT-IF SCENARIOS	89
Modeling the What-If Scenarios	89
Summary of System-Wide What-If Scenarios Results	92
By waterway zone analysis results of What-If scenarios	97
Explanation format of by Waterway Zone analysis results	97
Gateway Terminal waterway zone results	100
Trans Mountain Pipeline waterway zone results	100
Delta Port geographic waterway zone results	101
Combined What-If scenario waterway zone results	101
8. RMM SCENARIOS	113
Modeling the Risk Management Scenarios	113
Summary of RMM Scenarios Results enacted on Base Case P	117
By waterway zone analysis results of RMM measures enacted on base case (P)	118
Summary of RMM Scenarios Results enacted on Gateway Terminal Case	119
By waterway zone analysis results of RMM measures enacted on Gateway What-If Scenario (Q)	124
Summary of RMM Scenarios Results enacted on Combined Case T	127
By waterway zone analysis results of RMM measures enacted on Combined What-If Scenario (T)	130
9. BENCH MARK/SENSITIVITY SCENARIOS	137
Modeling the High-Low levels for Tank Focus Vessels	138
Modeling the High-Low Levels for Cargo Focus Vessels	138
Modeling added variability in arrivals of what-if focus vessels	144
Bench marking the What-If Scenarios and the BM/Sensitivity Scenarios	146
Bench marking at vessel time exposure level	146
Bench marking at POTENTIAL accident frequency level	148
Bench marking at POTENTIAL oil loss level	148
Bench marking the RMM Scenarios and the BM/Sensitivity Scenarios	149
Bench marking at vessel time exposure level	149
Bench marking at POTENTIAL accident frequency level	150
Bench marking at POTENTIAL oil loss level	150
By waterway zone analysis results of BM/Sensitivity scenarios enacted on base case (P)	151
Summary of BM/Sensitivity Scenarios Results enacted on combined What-If scenario (T)	154
By waterway zone analysis results of BM/Sensitivity scenarios enacted on combined case (T)	155
10. CONCLUSIONS AND RECOMMENDATIONS	159
References	163
Appendix: Glossary and List of Acronyms	165
List of other VTRA meeting attendees	166

Table of Tables

Table 1. Short description of scenario analyses conducted utilizing the VTRA 2010 model.....	18
Table 2. Summary of VTRA 2010 system-wide scenario analyses results. Detailed analyses results by waterway zone are dispersed throughout this report and available at: http://www.seas.gwu.edu/~dorprj/tab4/publications_VTRA_Update.html	19
Table 3. A sample list of vessel names that are designated as different vessel types in VTOSS 2010	56
Table 4. Master vessel type definition for the 26 VTOSS vessel type classification used in the GW/VCU MTS simulation model.....	56
Table 5. Cargo vessels that were classified as passenger vessels in the VTOSS 2005 dataset	57
Table 6. Route and density data for 6 vessel master types generated using the GW/VCU MTS simulation model with 2005 VTOSS data and location definitions in Figure 29.	57
Table 7. Route and density data for 6 vessel master types generated using the updated GW/VCU MTS simulation model with 2010 VTOSS data and location definitions in Figure 29.	58
Table 8. AIS 2010 Crossing line counts by vessel types: cargo, tanker and passenger vessel. A: West Strait of Juan de Fuca crossing Line counts; B: Georgia Strait crossing Line counts; C: Puget Sound crossing line counts.....	68
Table 9. GW/VCU MTS Crossing line counts using VTOSS 2010 data by 26 different vessel type classifications.....	69
Table 10. GW/VCU VTRA model crossing line counts using VTOSS 2010 data by vessel master type.	69
Table 11. Descriptors and short descriptions of Base Case and four What-If Scenarios	89
Table 12. Descriptors and short description of Risk Mitigation Measure (RMM) scenarios modeled in VTRA 2010....	113
Table 13. Arrival Counts of Tankers for the three major refinery destinations in the VTRA 2010 study area	139

THIS PAGE IS LEFT
INTENTIONALLY BLANK

Table of Figures

Figure 1. Definition of 15 waterway zones and their descriptors in the VTRA 2010 study area.....	5
Figure 2. Organizational Chart of VTRA 2010 Steering Committee.	6
Figure 3. A causal chain of events inter-connected by causal pathways. Risk management questions attempt to block these causal pathways.	7
Figure 4. 2D depiction of the traffic density for all focus vessels.	8
Figure 5. 2D depiction of the traffic density for all non-focus vessels.....	8
Figure 6. 3D Geographic profile of Base Case 2010 POTENTIAL oil loss (Case P).....	10
Figure 7. 3D Geographic profile of POTENTIAL oil loss assuming all three What-If Scenarios are operational (Case T).	10
Figure 8. Relative comparison of POTENTIAL oil outflow by waterway zone. Blue bars show the percentage by waterway zone for the base case 2010 year, red bars show the percentage for Case T in terms of base case percentages. Absolute differences by waterway zone and relative multipliers by waterway zone are provided in the y-axis labels. (see Page 105 for detailed explanation of output format).....	12
Figure 9. By waterway zone comparison of POTENTIAL accident frequency before and after modeled implementation of a risk mitigation measure port folio enacted on the combined What-If Scenario (Case T). See Page 105 for detailed explanation of output format.....	15
Figure 10. By waterway zone comparison of POTENTIAL oil loss before and after modeled implementation of a risk mitigation measure port folio enacted on the combined What-If Scenario (Case T). See Page 105 for detailed explanation of output format.....	15
Figure 11. Graphic of 158 representative routes for oil tankers used in VTRA 2005 MTS simulation model.	38
Figure 12. Example representative speed distribution for oil tankers (A), container vessel (B), bulk carriers (C) and navy vessels (D) estimated from VTOSS 2005 data. Step functions indicate the empirical probability distribution functions (pdf), whereas the solid lines are fitted Generalized Trapezoidal Distributions (GTD)[18].	39
Figure 13. Graphical depiction of counting situations in the VTRA simulation model.	40
Figure 14. Example question during 2005 VTRA of a paired comparison questionnaire of situations for tanker collision accident attribute parameter assessment given all incidents.....	42
Figure 15. Single hull and double hull 150,000 DWT tanker designs used in 2005 VTRA taken from the National Research Council SR259 report [15].	43
Figure 16. A schematic of a striking ship-struck ship probability model used in the 2005 VTRA.....	43
Figure 17. Title page of National Research Council SR259 report [15]	44
Figure 18. An example of a geographic profile of oil spill risk (generated during the 2005 VTRA).....	45
Figure 19. Coverage area of the Vessel Traffic Operational Support System (VTOSS).	47
Figure 20. In total 1756 representative vessel route were constructed from 2005 VTOSS data during the 2005 VTRA to model the movement of VTS responding traffic in the GW/VCU MTS simulation model.....	48
Figure 21. Tornado diagram displaying the cumulative percentage of time a vessel of a certain type is moving with the study area in the 2005 VTRA model over the course of one simulation year.....	48
Figure 22. In total 22 (47) representative vessel route were constructed from 2005 VTOSS data during the 2005 VTRA to model the movement of container vessel (bulk carrier) traffic in the GW/VCU MTS simulation model.....	49
Figure 23. Route plots of the VTOSS 2010 data after algorithmically joining route segments.	50

FINAL REPORT: VTRA 2010

Figure 24. A route affected by the time problem after midnight in the VTOSS 2010 data.....	51
Figure 25. A route affected by problems identifying the correct location of the vessel.....	51
Figure 26. Left panel: 2,345 route segments after algorithmic cleaning of oil tanker routes. Right panel: 2328 route segments following manual cleaning of tankers routes following algorithmic cleaning.....	52
Figure 27. Left panel: 3,453 route segments after algorithmic and manual cleaning of container vessel routes. Right panel: 6265 route segments following algorithmic and manual cleaning of bulk carrier routes.....	52
Figure 28. Left panel: Oil density tanker geographic profile generated using left panel routes in Figure 26. Right panel: Oil density tanker geographic profile generated using right panel routes in Figure 26.....	52
Figure 29. Waterway zone definitions used for the update of the GW/VCU MTS simulation from VTOSS 2005 to VTOSS 2010 data.....	54
Figure 30. Expanded and revised shore line definition in VTRA 2010 model.....	54
Figure 31. Left panel: Time series of counts of all vessels excluding ferries, yachts and fishing vessels in the system for the GW/VCU MTS simulation model using the VTOSS 2010 dataset; Right panel: Same using the VTOSS 2005 dataset.....	59
Figure 32. Left panel: Time series of counts of all ferries, yachts and fishing vessels in the system for the GW/VCU MTS simulation model using the VTOSS 2010 dataset; Right panel: Same using the VTOSS 2005 dataset.....	59
Figure 33. A route followed by the Westwood Rainier cargo vessel and its calculated average speed.....	60
Figure 34. The distribution of the speed accuracy factor for all transits.....	61
Figure 35. A: Incident rate per moving hour by focus vessel; B: Moving hours in VTRA 2010 model by focus vessel; C: Potential number incidents per year by focus vessel.....	62
Figure 36. 2D Traffic density of tugs towing/pushing oil barges in the VTRA 2010 model.....	64
Figure 37. 3D Traffic density of tugs towing/pushing oil barges in the VTRA 2010 model.....	64
Figure 38. A: Overview of three AIS crossing definitions; B: Close-up view of crossing line at the West Strait of Juan de Fuca Entrance; C: Close-up view of crossing line at the George Strait entrance; D: Close-up view of the crossing line at the Puget Sound entrance.....	67
Figure 39. Comparison of AIS 2010 and VTOSS 2010 crossing line counts for cargo, tanker and passenger vessels for the West Strait of Juan de Fuca crossing line depicted in Figure 38B.....	71
Figure 40. Comparison of AIS 2010 and VTOSS 2010 crossing line counts for cargo, tanker and passenger vessels for the Georgia Strait crossing line depicted in Figure 38C.....	71
Figure 41. Comparison of AIS 2010 and VTOSS 2010 crossing line counts for cargo, tanker and passenger vessels for the Puget Sound crossing line depicted in Figure 38D.....	71
Figure 42. Focus Vessel Classification of VTRA 2010 vessel types.....	73
Figure 43. 2D depiction of the traffic density for all non-focus vessels.....	74
Figure 44. 3D depiction of the traffic density for all non-focus vessels.....	74
Figure 45. 2D depiction of the traffic density for all focus vessels.....	75
Figure 46. 3D depiction of the traffic density for all focus vessels.....	75
Figure 47. Comparison of the total vessel time of exposure by focus vessel classification.....	77
Figure 48. Comparison of the total oil time of exposure by focus vessel classification.....	77
Figure 49. The traffic density for cargo focus vessels.....	79

FINAL REPORT: VTRA 2010

Figure 50. The traffic density for tank focus vessels.....	79
Figure 51. The total oil movement density for all focus vessel	79
Figure 52.The product oil movement density for all focus vessels.	80
Figure 53.The crude oil movement density for all focus vessels.....	80
Figure 54.The fuel oil movement density for all focus vessels.	80
Figure 55. Accident exposure (A), accident frequency (B), cargo oil loss (C), and fuel oil loss (D) by accident type.	81
Figure 56.The potential accident frequency by accident type and focus vessel type.....	83
Figure 57.The potential oil loss by accident type and focus vessel type.....	83
Figure 58.The geographic profile of the collision exposure.....	85
Figure 59.The geographic profile of the POTENTIAL collision frequency.....	85
Figure 60.The geographic profile of the POTENTIAL collision oil outflow.	85
Figure 61.The geographic profile of the grounding exposure.	86
Figure 62.The geographic profile of the POTENTIAL grounding frequency.	86
Figure 63.The geographic profile of the POTENTIAL grounding oil outflow.....	86
Figure 64.The geographic profile of POTENTIAL accident (collision + grounding) frequency.	87
Figure 65.The geographic profile of POTENTIAL accident (collision + grounding) oil outflow.....	87
Figure 66. The routes used for the What-If vessels in the Gateway case.....	90
Figure 67.The routes used for the What-If vessels in the Trans-Mountain Pipeline Expansion case.....	90
Figure 68.The routes used for the What-If vessels in the Delta Port case.....	90
Figure 69.The tug routes used for additional bunkering in the What-If scenarios.	91
Figure 70. An indirect effect of a What-If scenario – the change in timing of the tanker transits causes two tankers to interact with a fishing fleet returning to port at the end of the day.....	93
Figure 71. An overview comparison of the changes from the 2010 base case for each What-If scenario in terms of vessel time of exposure, POTENTIAL collision frequency, and POTENTIAL grounding frequency.....	95
Figure 72. An overview comparison of the changes from the 2010 base case for each What-If scenario in terms of fuel oil movement exposure, POTENTIAL collision fuel oil loss, and POTENTIAL grounding fuel oil loss.....	95
Figure 73. An overview comparison of the changes from the 2010 base case for each What-If scenario in terms of cargo oil movement exposure, POTENTIAL collision cargo oil loss, and POTENTIAL grounding cargo oil loss.....	96
Figure 74. An overview comparison of the changes from the 2010 base case for each What-If scenario in terms of vessel time exposure, POTENTIAL accident frequency, and POTENTIAL accident oil loss.....	96
Figure 75. Relative comparison of POTENTIAL oil outflow by waterway zone. Blue bars show the percentage by waterway zone for the base case 2010 year, red bars show the percentage for Case T in terms of base case percentages. Absolute differences by waterway zone and relative multipliers by waterway zone are provided in the y-axis labels.	98
Figure 76. By waterway zone comparison of POTENTIAL accident frequency and POTENTIAL oil outflow of Case Q with Case P. For a detail explanation of output format see Page 105.....	102
Figure 77. By waterway zone comparison of POTENTIAL accident frequency and POTENTIAL oil outflow of Case R with Case P. For a detail explanation of output format see Page 105.....	102

FINAL REPORT: VTRA 2010

Figure 78. By waterway zone comparison of POTENTIAL accident frequency and POTENTIAL oil Outflow of Case S with Case P. For a detail explanation of output format see Page 105.....	103
Figure 79. By waterway zone comparison of POTENTIAL accident frequency and POTENTIAL oil outflow of Case T with Case P. For a detailed explanation of output format see Page 105.	103
Figure 80.POTENTIAL accident frequency geographic profile comparison between Case P and Case Q.....	104
Figure 81.POTENTIAL oil outflow geographic profile comparison between Case P and Case Q.	105
Figure 82.POTENTIAL accident frequency geographic profile comparison between Case P and Case R.	106
Figure 83.POTENTIAL oil outflow geographic profile comparison between Case P and Case R.	107
Figure 84.POTENTIAL accident frequency geographic profile comparison between Case P and Case S.....	108
Figure 85.POTENTIAL oil outflow geographic profile comparison between Case P and Case S.....	109
Figure 86.POTENTIAL accident frequency geographic profile comparison between Case P and Case T.	110
Figure 87.POTENTIAL oil outflow geographic profile comparison between Case P and Case T.....	111
Figure 88. Vessel time exposure of Gateway What-If focus vessels under three Gateway Scenarios.....	115
Figure 89. Definition of areas for escorting RMM scenario analyses in the VTRA 2010 model.	116
Figure 90. Summary Analysis results of RMM Scenario Analysis enacted on the base case (P).	118
Figure 91. Waterway zone POTENTIAL accident frequency results comparison of RMM's enacted on base case (P). For a detailed explanation of output format see Page 105.....	120
Figure 92. Waterway zone POTENTIAL oil outflow results comparison of RMM's enacted on base case (P). For a detailed explanation of output format see Page 105.	121
Figure 93. 3D geographic profile POTENTIAL accident frequency results of RMM's enacted on base case (P)	122
Figure 94. 3D geographic profile POTENTIAL oil outflow results of RMM's enacted on base case (P)	123
Figure 95. Summary Analysis results of RMM Scenario Analysis enacted on the Gateway What-If Scenario (Q).	124
Figure 96. Waterway zone POTENTIAL accident frequency and POTENTIAL oil outflow results comparison of RMM's enacted on Gateway What-If Scenario (Q). For a detailed explanation of output format see Page 105.....	125
Figure 97. 3D geographic profile POTENTIAL oil outflow results of RMM's enacted on the Gateway What-If Scenario (Q)	126
Figure 98. Summary Analysis results of RMM Scenario Analysis enacted on the Combined What-If Scenario (T).	128
Figure 99. Waterway zone Oil Time Exposure comparison between Combined What-If Scenario (T) and the Base Case (P). For a detailed explanation of output format see Page 105.....	129
Figure 100. Waterway zone POTENTIAL accident frequency results comparison of RMM's enacted on Gateway What-If Scenario (Q). For a detailed explanation of output format see Page 105.	131
Figure 101. Waterway zone POTENTIAL oil outflow results comparison of RMM's enacted on Gateway What-If Scenario (Q). For a detailed explanation of output format see Page 105.	132
Figure 102. 3D geographic profile POTENTIAL accident frequency results of RMM's enacted on the Combined What-If Scenario (T)	133
Figure 103. 3D geographic profile POTENTIAL oil outflow results of RMM's enacted on the Combined What-If Scenario (Q).....	113

FINAL REPORT: VTRA 2010

Figure 104. A: Overview of three AIS crossing definitions; B: Close-up view of crossing line at the West Strait of Juan de Fuca Entrance; C: Close-up view of crossing line at the George Strait entrance; D: Close-up view of the crossing line at the Puget Sound entrance.	137
Figure 105. High-Low traffic year analysis conducted on 1998-2012 MXPS refinery arrival count data in Table 13 ...	140
Figure 106. 2D and 3D Geographic profiles of added tanker and cargo focus vessel traffic in bench mark/sensitivity analyses enacted on the VTRA 2010 base case (P) and the combined What-If Scenario (T).	141
Figure 107. AIS Crossing line count data from 2008-2012 for Neah Bay, Admiralty Inlet and Point Roberts crossing lines depicted in Figure 104.	142
Figure 108. Traffic flow analysis based on 2008-2012 AIS crossing line count data provided in Figure 107.	143
Figure 109. A 5-year trend analysis of cargo focus vessel traffic flows based on 2008-2012 AIS crossing line count data provided in Figure 107.	145
Figure 110. Equidistant arrivals of What-If focus vessels and modeling of random arrivals within equidistant time intervals to test effect of added variability in What-If focus vessel arrivals.	146
Figure 111. Summary Analysis results of BM/Sensitivity Scenario Analysis enacted on the base case (P).	147
Figure 112. Waterway zone POTENTIAL accident frequency. and oil outflow results comparison of high and low Scenarios enacted on base case (P). For a detailed explanation of output format see Page 105.	152
Figure 113. Geographic profiles of POTENTIAL accident frequency and oil outflow for high and low Scenarios enacted on base case (P)	153
Figure 114. Summary Analysis results of BM/Sensitivity Scenario Analysis enacted on the Combined What-If Case (T).	155
Figure 115. Waterway zone POTENTIAL accident frequency. and oil outflow results comparison of high and low Scenarios enacted on Combine Case (T). For a detailed explanation of output format see Page 105.	156
Figure 116. Geographic profiles of POTENTIAL accident frequency and oil outflow for high and low Scenarios enacted on combined case (T)	157

THIS PAGE IS LEFT
INTENTIONALLY BLANK

1. INTRODUCTION

Washington State shares the Salish Sea with the province of British Columbia. A large number of ships and barges operate in these shared waters, placing the area at risk for major oil spills. While a recent study [2] demonstrated significant risk reduction of oil transportation risk due to existing risk mitigation measures⁴, the potential for large spills continues to be a prominent concern for the region's environment, economy and quality of life, and the impact of a major spill would likely be devastating on the long-term restoration and protection of Puget Sound and Salish Sea waters. Public concern for protecting the environment while pursuing maritime economic developments was the catalyst for this study funded by the EPA through the State of Washington and the Makah Tribe. The VTRA study area includes: (1) portions of the Washington outer coast, (2) the Strait of Juan de Fuca and (3) the approaches to and passages through the San Juan Islands, Puget Sound and Haro-Strait/Boundary Pass.

The VTRA analysis is predominantly based on Vessel Traffic Operational Support System (VTOSS) 2010 data and will therefore be referred to as VTRA 2010 hereafter. Vessel traffic collision and grounding risks are evaluated for tank focus vessels (oil tankers, chemical carriers, oil barges and articulated tug barges) and cargo focus vessels (bulk carriers, container ships and other cargo vessels). The VTRA 2010 analysis shall serve as a base case year to compare potential changes in risk as a result of potential maritime terminal developments against. The purpose of this study is to inform the State of Washington, the United States Coast Guard and the Puget Sound Harbor Safety Committee on what actions could be taken to mitigate increases in oil spill risk from large commercial vessel oil spills in the northern Puget Sound and the Strait of Juan de Fuca as a result. It is also intended to inform tribes, local governments, industry and non-profit groups in Washington State and British Columbia on potential risk management options and to facilitate their input towards achieving consensus risk management decisions regarding vessel operations in the study area.

For context it is important to recognize that the base case 2010 VTRA analysis includes a series of risk mitigation measures. In addition to the previously mentioned IMO Traffic Separation Scheme and CVTS, vessels are subject to Port State Control and other vessel inspections regimes in both Canada and the United States to enforce international and federal standards. Pilotage is required in both the U.S. and Canada and pilotage areas are comparable. Tug escorts for laden tankers are required and tugs are used to assist vessels into and out of the berths. Moreover, there are a number of risk mitigation measures that have been put in place internationally, federally and locally over the last several decades including double hulls for tankers, protectively located fuel tanks for non-tank vessels (still being phased in), a Puget Sound Harbor Safety Plan with

⁴ In [2] a 91.6% reduction in POTENTIAL oil loss was evaluated from all Tankers, Articulated Tug Barges (ATB's) and Integrated Tug Barges (ITB's) utilizing the VTRA 2005 model as a result of the implementation of the one-way zone regime in Rosario Strait, double hull tankers and the 2005 escorting regime.

FINAL REPORT: VTRA 2010

Standards of Care, the implementation of AIS, a traffic procedure governing vessels transiting Turn Point at the boundary between Haro Strait and Boundary Pass northeast of Victoria, Canada and a one-way zone regime in Rosario Strait. This list is not exhaustive. This study was not designed to measure the effectiveness of risk mitigation measures already in place.

The VTRA 2010 utilizes the extensive technical work already completed by the George Washington (GW) University and Virginia Commonwealth University (VCU) under prior projects. Specifically, the Prince William Sound Risk Assessment (1996), The Washington State Ferry Risk Assessment (1998), The San Francisco Bay Exposure Assessment (2004) and the 2005 Vessel Traffic Risk Assessment (VTRA)⁵. Our method has been developed over the course of over ten years of work in maritime risk assessment, has been peer reviewed by the National Research Council and top experts in the field of expert elicitation design and analysis, and has been improved thanks to a grant from the National Science Foundation and interactions with stakeholders over the course of the above maritime risk assessment projects. A reference list is provided at the end of this document.

Our analysis model represents the chain of events that could potentially lead to an oil spill. Figure 3 shows the accident causal chain. We call a situation in which an accident could occur an accident exposure. Maritime Transportation Systems (MTS) have accident exposures from the movement of vessels within it. For each accident exposure, while the vessel is underway, incident and accident probability models are used to calculate the potential accident frequency. This is not a prediction of an accident, but shows a relative propensity that an accident could occur in one situation versus another or the relative propensity for one type of accident versus another. The accident exposure and the potential accident frequency are then combined with an oil outflow model to calculate potential oil loss. Throughout this report we shall use the terminology POTENTIAL to indicate that an accident exposure does not necessarily need to lead to an accident or oil loss, but may.

Our analysis model evaluates the duration that vessels travel through the VTRA study area (referred to as Vessel Time Exposure, abbreviated VTE), by vessel type. The inclusion of the time on the water element in the evaluation of exposure sets the VTRA 2010 methodology apart from count based approaches that focus on, for example, number of annual/monthly vessel transits, visits or calls. The value of a duration-based approach versus a count-based approach is that the VTE approach appropriately distinguishes between short and long transits in the evaluation of vessel traffic risk as well as high and low vessel speeds.

All models are abstractions of reality however through a set of simplifying assumptions. For instance, we only included a limited set of factors in our expert judgment questionnaires,

⁵ The VTRA 2005 was limited to vessel traffic risk evaluation associated with tankers, atb's and itb's docking at the Cherry Point terminal.

otherwise we would have had to ask hundreds of questions and the experts would have grown tired and not have given useful, consistent information after a while. This also limits the level of granularity to which we can break down the factors. For instance, we must group similar types of vessels to reduce the number of categories (and questions) and we cannot model locations down to the seconds of the longitude and latitude coordinates. Essentially, as within any analysis model, we must make assumptions. However, we made every attempt to test our assumptions with experts and stakeholders through a collaborative analysis process. The updating of the 2005 VTRA model to the VTRA 2010 one followed this collaborative analysis approach involving coordination with Puget Sound stakeholders through the VTRA 2010 Steering Committee:

“In collaborative analysis, the groups involved in a policy debate work together to assemble and direct a joint research team, which then studies the technical aspects of the policy issue in question. Representative from all the participating groups are given the ability to monitor and adjust the research throughout its evolution. Collaborative analysis aims to overcome suspicions of distorted communication giving each group in the debate the means to assure that other groups are not manipulating the analysis. The ultimate goal is to generate a single body of knowledge that will be accepted by all the groups in the debate as a valid basis for policy negotiations and agreements. – George J. Busenberg, 1999.”

In this study, the VTRA 2010 Steering Committee (see Figure 2) chose to model only the traffic level impacts of planned expansion and construction projects that were in advanced stages of a permitting process. Each planned project forms a What-If scenario and What-If vessels are added to a maritime simulation of the 2010 Base Case year. Four What-If scenarios were modeled in the study:

- The Gateway bulk carrier terminal
- The Trans-Mountain pipeline expansion
- The combination of proposed changes at Delta Port
- All three of above scenarios operating at the same time

The Steering Committee determined that the following numbers of What-If vessels would be added to the 2010 Base Case simulation in each scenario:

- The Gateway bulk carrier terminal
 - 487 bulk carriers (318 Panama class and 169 Cape Max class)
- The Trans-Mountain pipeline expansion
 - 348 crude oil tankers (each 100,000 DWT)
- The combination of proposed changes at Delta Port
 - 348 bulk carriers and 67 container vessels
- All three of above scenarios operating at the same time

Moreover, the VTRA 2010 Steering Committee recommended that bunkering operations supporting these potential expansion projects be represented as well.

FINAL REPORT: VTRA 2010

A summary of the 2005 VTRA methodology is provided in Section 2 with references to peer-reviewed publications and technical report dispersed throughout this summary. Needless to say, to more closely approximate the present-day patterns in traffic for What-If scenario analysis representing potential traffic expansions, it would be desirable for the GW/VCU VTRA 2005 analysis model to be updated with the most recent VTOSS dataset. The 2010 year is the last full year of traffic data recorded for VTOSS. The items below summarize the improvements made to 2005 VTRA methodology while updating the GW/VCU VTRA analysis model using the VTOSS 2010 efforts over the course of both the Makah and PSP funded efforts:

1. The total focus vessel class in the VTRA 2010 accounts for approximately 25% of the total traffic picture, whereas the VTRA 2005 only accounted for 1% of the total traffic. The VTRA 2005 only considered BP Cherry point tankers, ATB's and ITB's within the focus vessel class⁶. As per the PSP SOW this focus vessel class was expanded to include all tankers, ATB's and ITB's, bulk carrier, container vessels and oil barges. Over the course of the VTRA 2010, also "Chemical Carriers" and "Other Cargo" were added to the VTRA 2010 focus vessel class. The chemical carrier class is about as large as the ATB one. The "Other Cargo" class is combined about as large as the container focus vessel class. The inclusion of both "Chemical Carrier" and "Other Cargo" to the focus vessel class provides for an even more comprehensive analysis.
2. Individual vessel routes segments are used in the VTRA 2010, rather than using representative routes that were used back in the VTRA 2005 to create a more accurate traffic picture.
3. VTOSS 2010 data, which serves as the basis for the VTRA 2010, was validated against Automatic Identification System (AIS) 2010 data. This was not possible for the VTRA 2005 since at that time no AIS data was available. To accommodate this validation we:
 - a. Introduced the notion of a vessel master type (Cargo-Focus Vessel and Tank-Focus Vessel) necessitated by vessel type misclassifications observed both in the VTOSS 2005 and VTOSS 2010 datasets.
 - b. Added crossing line counting to the VTRA model to duplicate exactly the AIS 2010 crossing line count procedure.
4. Calculated speeds are used in VTRA 2010 model as opposed to sampled speeds in the VTRA 2005 to more accurately reflect exposure times of focus vessel classes.
5. In terms of potential oil outflow analysis we are considering overall oil loss, cargo oil loss and fuel oil loss and we are providing separate analyses for each. This is a change from the former "persistent oil" and "non-persistent oil" classification used in the VTRA 2005 and mentioned in the PSP SOW. However, the oil loss, cargo oil loss and fuel oil loss classification is more meaningful given the focus vessel class expansion.
6. Analysis capability was created to not only include more vessel types to the focus vessel class, but also allow for separation of the analysis by each focus vessel type, as well as the Tank-FV and Cargo-FV master type. Allowing for separation of analysis by focus vessel type may prove useful during the risk management phases.

⁶ During the 2005 VTRA, focus vessels were referred to as Vessels Of Interest (VOI's)

7. The notion of What-If focus vessels was introduced to model the added traffic to the 2010 base year to represent the potential addition of Gateway, the Trans Mountain and Delta-Port expansions. This allows for a separation of added system risk into What-If focus vessel risk and risk added to the Base Case focus vessel class (as a result of adding What-If focus vessels).
8. A bunkering model was added to the VTRA 2010 model. Inclusion of a bunkering model to support these What-If focus vessels is an important part of the What-If analysis. The bunkering model addition to the VTRA model for What-If scenarios was not foreseen during the initial SOW negotiations and was not included in 2005 VTRA. Analysis capability was created to allow for separation of What-If risk into "bunkering risk" and "Other What-If FV" risk.
9. The comprehensiveness of the analysis makes synthesis into an overall system view that highlights important aspects of analysis results more challenging. A great deal of time was spent to develop an analysis presentation format to arrive more easily at such a systems view of risk. Most importantly, these synthesized presentation and analysis results will allow stakeholders (hopefully) to still see "the forest through the trees". It is important for stakeholders to have this overall systems view prior to devising risk management suggestions.
10. Progress presentations and detailed scenario result presentations are available in electronic portable document format (pdf) from a VTRA 2010 project web-page:

http://www.seas.gwu.edu/~dorpjr/tab4/publications_VTRA_Update.html

In Section 3, we describe the updating of the 2005 VTRA model to the 2010 VTRA in more detail. In Section 4, the validation of GW/VCU model crossing line counts using AIS 2010 crossing line counts is described. Section 5 describes VTRA 2010 focus vessel traffic movement and the movement of oil volume that these focus vessels carry. The information described in Section 5 serves as the starting point for the base case VTRA 2010 potential accident frequency and oil outflow analysis described in Section 6. The modeling of What-If scenario's and the changes in POTENTIAL accident frequency and POTENTIAL oil outflow from the VTRA 2010 Base Case is presented in Section 7. In Section 8, similar analysis results are presented for a variety of RMM scenarios, whereas Section 9 describes the construction of bench mark/sensitivity analysis scenarios to compare the What-If and RMM scenarios against. We close the report with conclusions and recommendations in Section 10.

THIS PAGE IS LEFT
INTENTIONALLY BLANK

2. SUMMARY 2005 VTRA MODEL METHODOLOGY

Is it safer for a river gambling boat in New Orleans to be underway than to be dockside? Should wind restrictions for outbound tankers at Hinchinbrook Entrance in the Prince William Sound Alaska be lowered from 40 knots to 35 knots? Is investment in additional life craft on board Washington State Ferries in Seattle warranted or should the International Safety Management (ISM) code be implemented fleet wide? Can enhanced ferry service in San Francisco Bay and surrounding waters alleviate traffic congestion on roadways in a safe manner? Do potential traffic increases made possible through the addition of a pier terminal at a refinery located north of the San Juan Islands in Washington State increase or reduce oil transportation risk?

The risk management questions above were raised in a series of projects over a time frame spanning more than 10 years and were addressed using a single risk management analysis methodology developed over the course of these projects by a consortium of universities. This methodology centers around stakeholder involvement and dynamic maritime risk simulations of a Maritime Transportation Systems (MTS) that also integrate incident/accident data collection, expert judgment elicitation and consequence models [2]-[3].

It has been peer reviewed by the National Research Council [4], top experts in the field of expert elicitation design and analysis, and has been continuously improved over time since its initial development in 1996. The model has previously been used in the Prince William Sound Risk Assessment ([5]-[8]), the Washington State Ferries Risk Assessment[9], and the Exposure Assessment of the San Francisco Bay ferries [10]. The model was most recently used during the 2005 VTRA [11] - [13]. Prior to updating with 2010 VTOSS data, data use and model assumptions of the VTRA model have been peer-reviewed [2] - [13].

Our analysis approach of involving stakeholders has been referred to in [1] as the collaborative analysis approach:

“In collaborative analysis, the groups involved in a policy debate work together to assemble and direct a joint research team, which then studies the technical aspects of the policy issue in question. Representative from all the participating groups are given the ability to monitor and adjust the research throughout its evolution. Collaborative analysis aims to overcome suspicions of distorted communication giving each group in the debate the means to assure that other groups are not manipulating the analysis. The ultimate goal is to generate a single body of knowledge that will be accepted by all the groups in the debate as a valid basis for policy negotiations and agreements. – George J. Busenberg, 1999.”

The following is a brief description of this modeling approach. The updating of the 2005 VTRA model using 2010 VTOSS data followed the same collaborative approach used during the construction of the VTRA 2005 model, i.e. by making progress presentations to the Puget Sound Harbor Safety Committee and engaging stakeholders represented therein.

Situations (see Figure 3):

Accidents can only occur when vessels are transiting through the system. Our maritime simulation model attempts to re-create the operation of vessels and the environment for one calendar year within the geographic scope of the study through maritime simulation/ replication. The traffic modeled re-plays the movement of VTS participating vessels (using 2005 VTOSS data) and simulates the movement of smaller fishing vessels, whale watchers, and organized regatta events over a set of representative routes using representative vessel speeds. Representative vessel routes were constructed by vessel type using the 2005 VTOSS data set. Figure 11 provides a graphic of the 158 representative routes constructed for Oil Tankers. Vessels speeds are sampled from representative speed distribution by vessel type estimated using the West Strait of Juan de Fuca 2005 VTOSS data. Figure 12 plots example representative speed distributions for oil tankers, container vessels, bulk carriers and navy vessels used in the 2005 VTRA study. From Figure 12 one observes that the speed profile for oil tankers and bulk carriers is quite similar, whereas container vessels typically travel at higher speeds. The speed profile for navy vessels indicates a lot of variation in their speeds compared to the other vessel types in Figure 12. For each vessel type a representative speed distribution was fitted from vessel West Strait of Juan de Fuca speeds

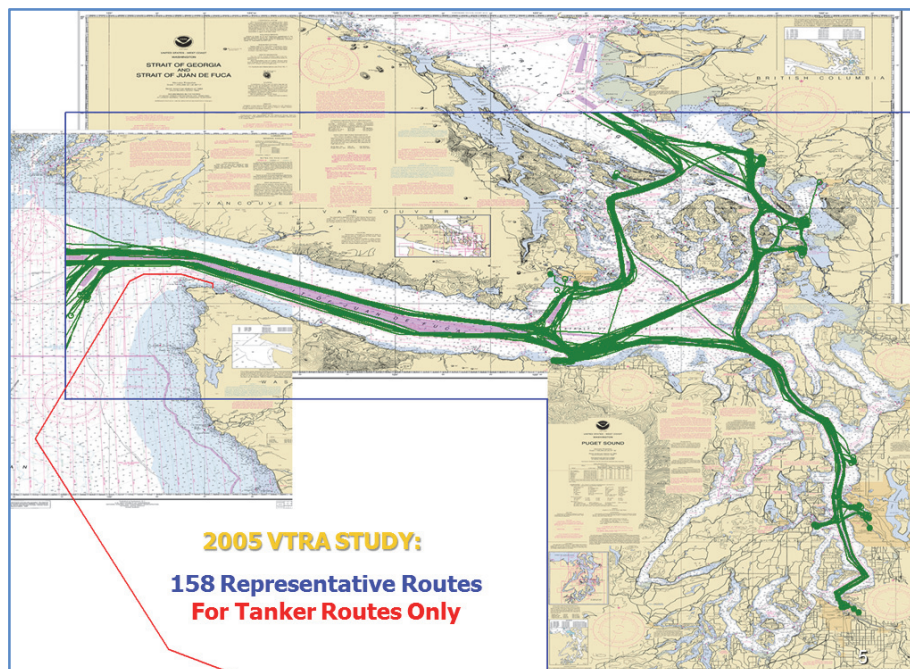

Figure 11. Graphic of 158 representative routes for oil tankers used in VTRA 2005 MTS simulation model.

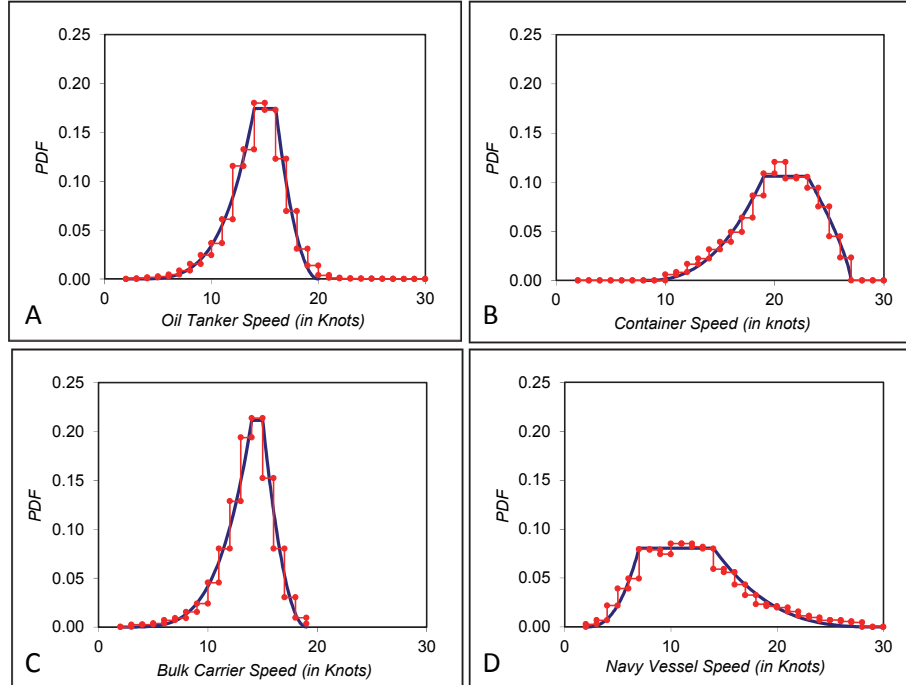

Figure 12. Example representative speed distribution for oil tankers (A), container vessel (B), bulk carriers (C) and navy vessels (D) estimated from VTOSS 2005 data. Step functions indicate the empirical probability distribution functions (pdf), whereas the solid lines are fitted Generalized Trapezoidal Distributions (GTD)[18].

observed in the VTOSS 2005 data. A vessel's sample speed is assumed constant throughout its transit, but subject to location speed changes trumped by traffic rules speed changes according to study area traffic rules implemented in the 2005 VTRA model. Location speed multipliers were estimated by comparing average speeds by vessel type for locations East Strait of Juan de Fuca, Haro-Strait/Boundary Pass, Rosario Strait, Georgia Strait, Guemes Channel, Saddlebag, Puget Sound North, and Puget Sound South to the average West Strait of Juan de Fuca speeds.

The environmental factors modeled include wind, fog, and current. They are replayed hourly using publicly available data sources, such as e.g. the National Climatic Data Center. (See, also [11], Appendix C). The update of the 2005 VTRA also includes updating to 2010 current tables. Other environmental conditions from the 2005 VTRA model are retained as well as traffic modeled therein not calling into VTS centers. Specifically, tribal and commercial fisheries, scheduled and USCG permitted regatta events and whale watching movements from the 2005 VTRA model are retained.

Every minute over a simulation calendar year, the 2005 VTRA model counts situations of moving vessels in which there is the potential for an accident to occur if things start to go wrong (see, e.g., [2]). The traffic conditions and environmental conditions are recorded in these situations and

stored in a database representing a one year analysis scenario (for example the base case and various What-If traffic scenarios).

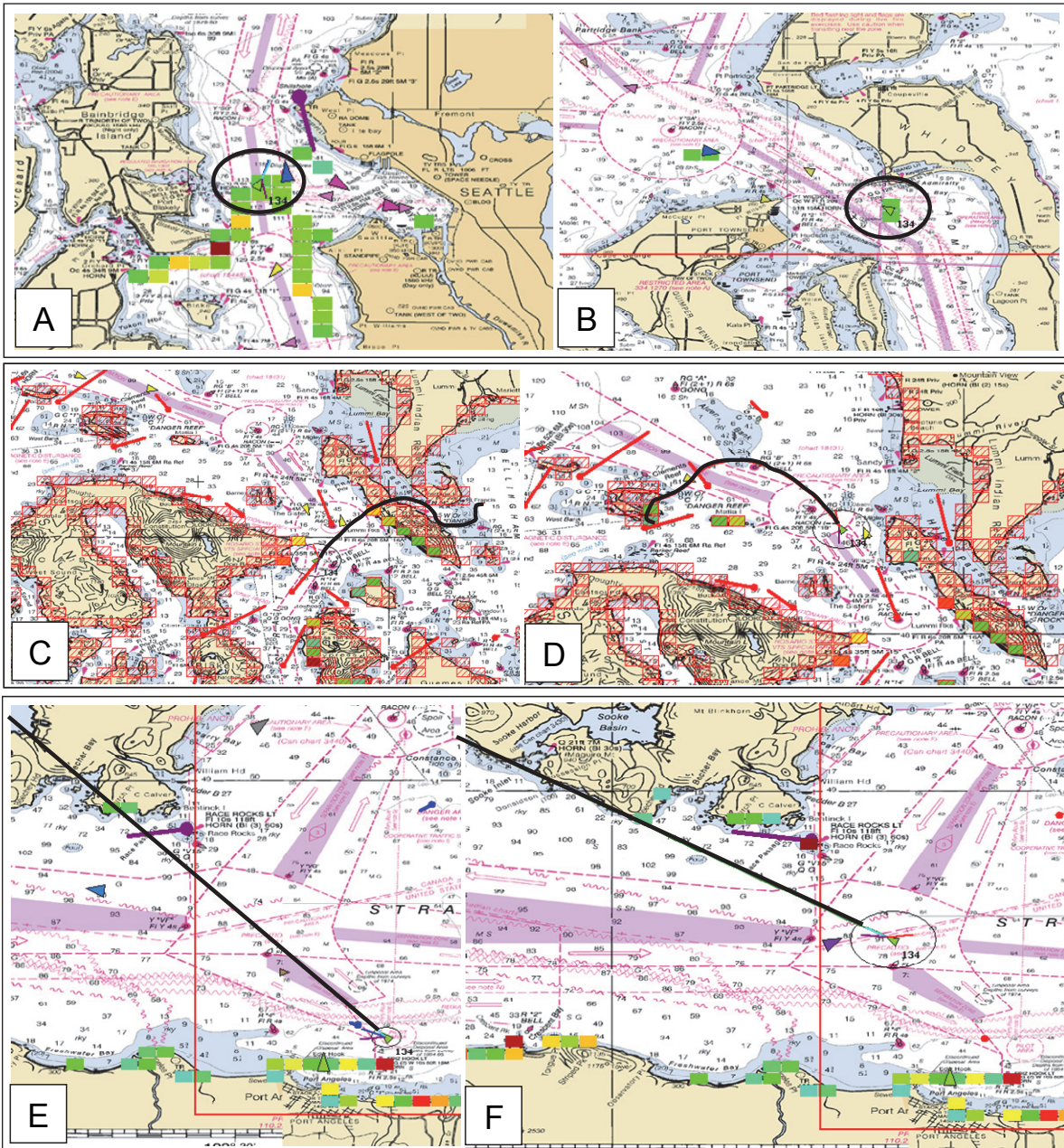

Figure 13. Graphical depiction of counting situations in the VTRA simulation model.

Incidents & Accidents (see Figure 3):

Incidents are the events that immediately precede the accident. The types modeled include, propulsion losses, total steering losses, loss of navigational aids, and human errors. An exhaustive analysis of all possible sources of study area relevant accident, near miss, incident, and unusual event data was performed (see, e.g. [11], Appendices A and B). The accident types included in this study are collisions between two vessels, groundings (both powered and drift), and allisions that involve the FV's. The simulation counts the situations in which accidents could occur, while recording variables that could affect the chance that an accident will occur; these include the proximity of other vessels, the types of the vessels, the location of the situation and its wind, visibility and current. Thankfully, incidents and accidents in this geographic area are rare and there is not enough data to say how each of these variables affects the chances of an accident⁷. To determine this, we turned to maritime experts. The VTRA model is calibrated to historically observed, but geographically restricted accident and incident data (see [11], Appendix E). As such, the annual accident and incident rates generated by the VTRA model for the base case scenario coincide with geographically restricted historically observed accident and incident rates for the calibration data set.

To determine how accident situations differ in terms of relative accident likelihood, we must turn to the experts due to this lack of data. We ask experts to assess the differences in risk of two similar situations that they have extensive experience of. In each question we change only one factor and through a series of questions we build our accident probability model, incorporating the data where we can. Our expert judgment elicitation procedure is described in detail in [2], [14]. An example question is shown in Figure 14; here an oil tanker with an untethered escort is meeting a ferry. The question asks how much an increased wind speed would affect an accident probability given the presence of the specified incident. The experts involved include tanker masters, tug masters, Puget Sound pilots, Coast Guard VTS operators, and ferry masters. A full description of the process, experts and series of questionnaires conducted during the 2005 VTRA is provided in [11], Appendix E. No additional expert judgment elicitation is conducted for the update of the 2005 VTRA model using 2010 VTOSS data.

Oil Spill (see Figure 3):

An oil outflow model [3] for collision and grounding accidents explicitly links input variables such as hull design (single or double, see Figure 15), displacement and speed, striking vessel displacement and speed, and the interaction angle of both vessels to output variables (see Figure 16): longitudinal and transversal damage extents of the tanker. Overlaying these damage extents on a vessel's design (see Figure 15) yields an oil outflow volume totaling the capacity of damaged

⁷ Over the course of our various studies typically less than ten accidents were observed in a time frame of ten years or more to calibrate the VTRA model.

tank compartments. A similar model was developed for grounding accidents during the 2005 VTRA.

Situation 1	TANKER DESCRIPTION	Situation 2
Strait of Juan de Fuca East	Location	-
Inbound	Direction	-
Laden	Cargo	-
1Escort	Escorts	-
Untethered	Tethering	-
INTERACTING VESSEL		
Shallow Draft Pass. Vessel	Vessel Type	-
Crossing the Bow	Traffic Scenario	-
Less than 1 mile	Traffic Proximity	-
WATERWAY CONDITIONS		
More than 0.5 mile Visibility	Visibility	-
Along Vessel	Wind Direction	-
Less than 10 knots	Wind Speed	25 knots
Almost Slack	Current	-
Direction	Current Direction	-
Complete Propulsion Loss		
More? : ____	9 8 7 6 5 4 3 2 1 2 3 4 5 6 7 8 9	____ : More?
Situation 1 is worse	<=====X=====>	Situation 2 is worse
Complete Steering Loss at a Moderate Angle		
More? : ____	9 8 7 6 5 4 3 2 1 2 3 4 5 6 7 8 9	____ : More?
Situation 1 is worse	<=====X=====>	Situation 2 is worse
Complete Navigational Aid Loss		
More? : ____	9 8 7 6 5 4 3 2 1 2 3 4 5 6 7 8 9	____ : More?
Situation 1 is worse	<=====X=====>	Situation 2 is worse
Human Error		
More? : ____	9 8 7 6 5 4 3 2 1 2 3 4 5 6 7 8 9	____ : More?
Situation 1 is worse	<=====X=====>	Situation 2 is worse
Nearby Vessel Incident (but you do not know the specifics)		
More? : ____	9 8 7 6 5 4 3 2 1 2 3 4 5 6 7 8 9	____ : More?
Situation 1 is worse	<=====X=====>	Situation 2 is worse

Figure 14. Example question during 2005 VTRA of a paired comparison questionnaire of situations for tanker collision accident attribute parameter assessment given all incidents.

A total of 80,000 simulation accident scenarios described in the National Research Council SR259 report [15] published in 2001 served as the joint data set of input and output variables used in this "linking" process. The title page of the SR259 report is depicted in Figure 17. The oil outflow model was designed keeping computational efficiency in mind to allow for its integration with a maritime transportation system (MTS) simulation. A full description of the oil outflow model developed during the 2005 VTRA including its parameters and their estimation is provided in [11], Appendix D.

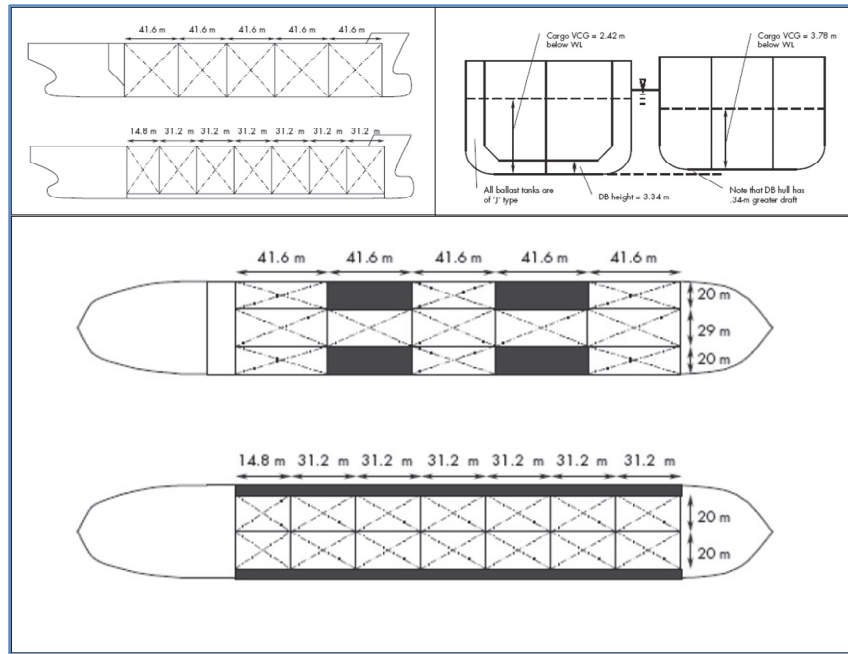

Figure 15. Single hull and double hull 150,000 DWT tanker designs used in 2005 VTRA taken from the National Research Council SR259 report [15].

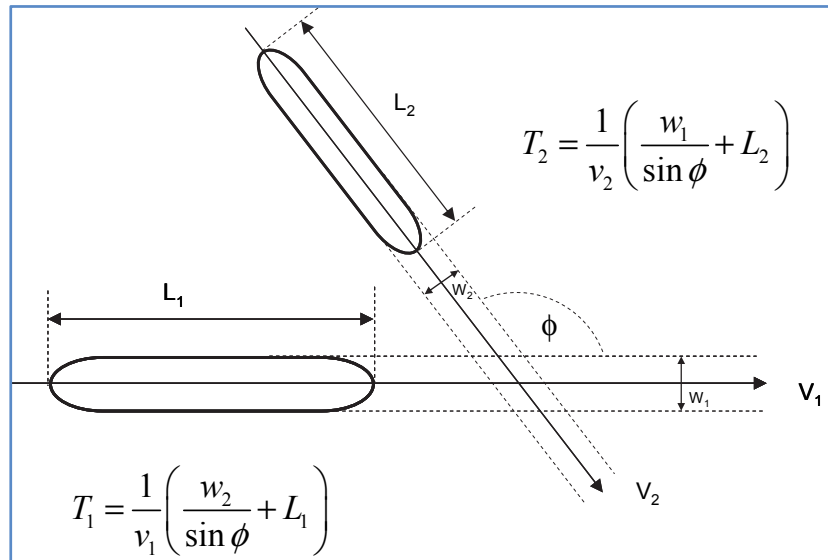

Figure 16. A schematic of a striking ship-struck ship probability model used in the 2005 VTRA.

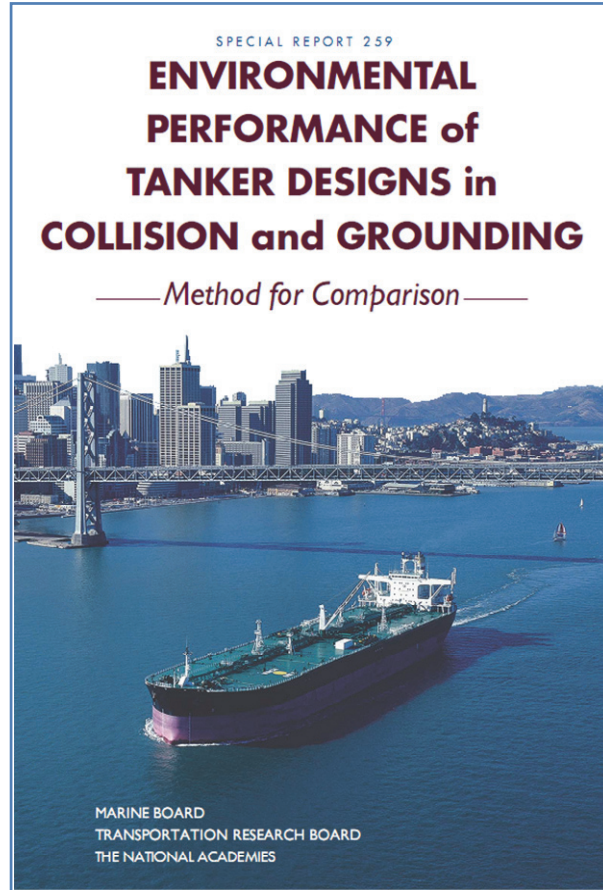

Figure 17. Title page of National Research Council SR259 report [15]

Format of Scenario Analysis Results and Comparisons (See Figure 18)

A potential risk mitigation scenario to be analyzed with the VTRA update is whether from a vessel risk perspective it makes sense to allow for bulk carriers docking at the Gateway facility being considered to travel north through Haro-Strait Boundary Passes as opposed to only using a northerly route through Rosario Strait. The 2005 VTRA only modeled a northerly route for Gateway vessels through Rosario Strait. 2005 VTRA model output allows for a visual assessment of the effectiveness of a risk mitigation scenario by comparing its geographic profile of vessel risk to that of other vessel traffic risk mitigations scenarios to a baseline geographic profile of vessel traffic risk (see Figure 18 for an example of such a geographic profile of vessel risk⁸). An advantage of the geographic profile display format in Figure 18 is that it allows for a direct visual

⁸ The VTRA 2005 analysis in [11] was limited to vessel traffic risk evaluation associated with Tankers, ATB's and ITB's docking at the Cherry Point terminal.

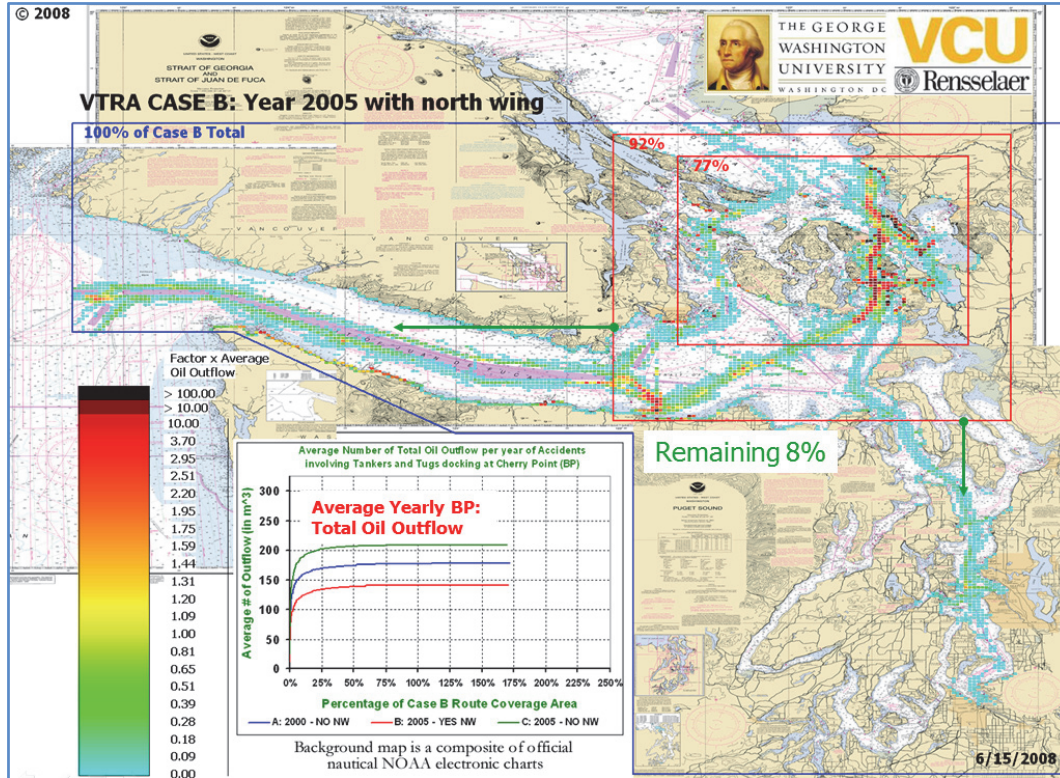

Figure 18. An example of a geographic profile of oil spill risk (generated during the 2005 VTRA).

assessment of the distribution of the analysis results and thus provides for an understanding of system risk. For example, we immediately observe from Figure 18 larger risk levels in the areas of Rosario Strait, Haro-Strait Boundary Pass, Guemes Channel and at route convergence locations at Buoy J and Port Angeles. A visual comparison of a baseline scenario generated geographic profile and that of a What-If and risk mitigation scenario allows for a visual assessment of potential increases and decreases in risk and their location. The percentages in the top left corners of the red rectangles and blue border of the study area in Figure 18 allow for a more quantitative evaluation of system risk and its changes from a baseline scenario to What-If and RMM scenario analysis results. The fact that in Figure 18 the percentage in the top left of the blue border equals 100% implies that this is a baseline geographic profile. For a more detailed explain of geographic risk profile interpretation see [12].

Sensitivity and Uncertainty of Analysis Results

More data is being made available electronically over time allowing for an even more accurate representation of the movement of vessel traffic and modeling of the accident scenarios within an MTS simulation. As a result, the movement of traffic within the MTS simulation more resembles a replication of how vessels actually moved rather than simulating them. An example being that every vessel in the MTS simulation arrives and departs as per the VTOSS 2010 data while

retaining its route segments and vessel characteristics, such as e.g. its own vessel name. No doubt, this added level of detail reduces model uncertainty to a great extent. The evaluation of model uncertainty is not accounted for in traditional sensitivity/uncertainty analysis approaches.

With the increased availability of this electronic data, however, the time to prepare it in an electronic format that can serve as input to an MTS simulation increases as well. Despite these advances, one should always bear in mind that any model is an abstraction of reality in which simplifying assumptions are often necessitated to maintain computational efficiency. The increase of computational complexity to reduce model uncertainty within the 2005 VTRA methodology, does unfortunately not allow for the application of traditional sensitivity/uncertainty analysis of output analysis results. We are pushing computational boundaries of existing computation platforms that the 2005 VTRA model runs on. As a result, we find that solely relative comparisons across accident types, across oil outflow categories and across risk intervention scenarios are particularly enlightening and informative and we concentrate less on the absolute values of the results in our analysis comparisons.

That being said, uncertainty of output analysis results for the 2005 VTRA methodology has been studied and funded by the National Science Foundation for smaller analysis context instances (See, [16], [17]). In these studies it was concluded that ranking of scenarios/alternatives are robust within our analysis methodology with respect to changes in vessel traffic. A small number of bench/mark sensitivity analyses in which traffic levels are varied may further serve as a guide to judge risk level changes as traffic levels change.

FINAL REPORT: VTRA 2010

3. UPDATING THE 2005 VTRA GW/VCU Model USING VTOSS 2010 DATA

By updating the 2005 VTRA model to a 2010 base year, it will more closely approximate the present-day patterns in traffic when using the GW/VCU VTRA analysis model to inform, for example, the State of Washington and the United States Coast Guard on what potential actions should be taken to mitigate increases in oil spill risk from large commercial vessel oil spills in the northern Puget Sound and the Strait of Juan de Fuca areas. The data source for modeling Vessel Traffic Service (VTS) responding traffic in the 2005 VTRA model was VTOSS 2005 data. Figure 19 displays the VTOSS coverage area including the Seattle, Tofino and Victoria VTS that service this area covering both US and Canadian waterways. An advantage of the VTOSS data is that it provides a single US - Canadian cross boundary data source for the three VTS providers. However, this too provides for one of the challenges when modeling vessel traffic as recording across these three VTS providers in the VTOSS data set is not consistent. For example, a vessel travelling through these three VTS areas on a single transit is assigned three separate trip ID's, one for each VTS.

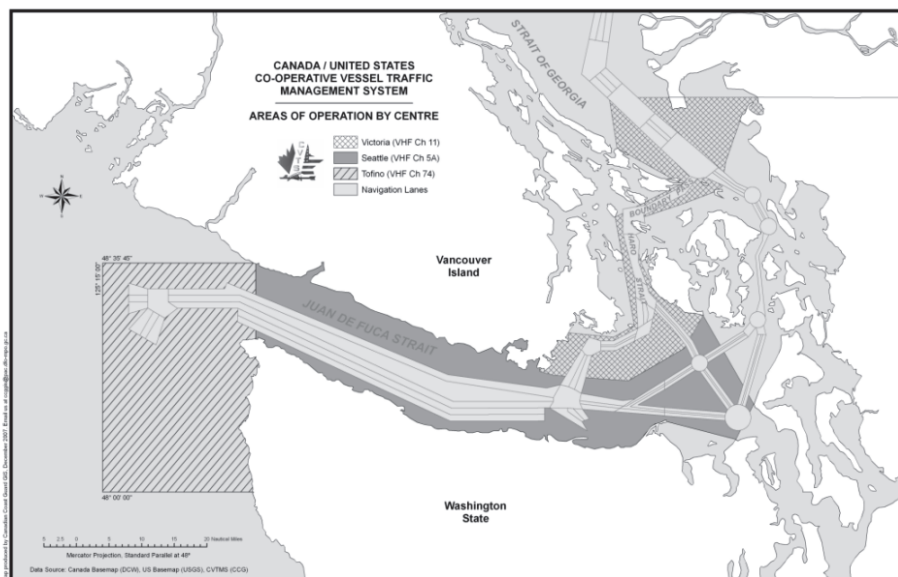

Figure 19. Coverage area of the Vessel Traffic Operational Support System (VTOSS).

To deal with this particular data issue, a modeling decision was made during the 2005 VTRA to resort to the construction of representative vessel routes by vessel type. In total 1756 representative vessel routes, depicted in Figure 20, were constructed to model all VTS responding traffic (both US and Canadian). Of that, a relative large number of 158 representative routes, depicted in Figure 12, were constructed to model the movement of oil tankers ($\approx 2\%$ of all traffic, see Figure 21).

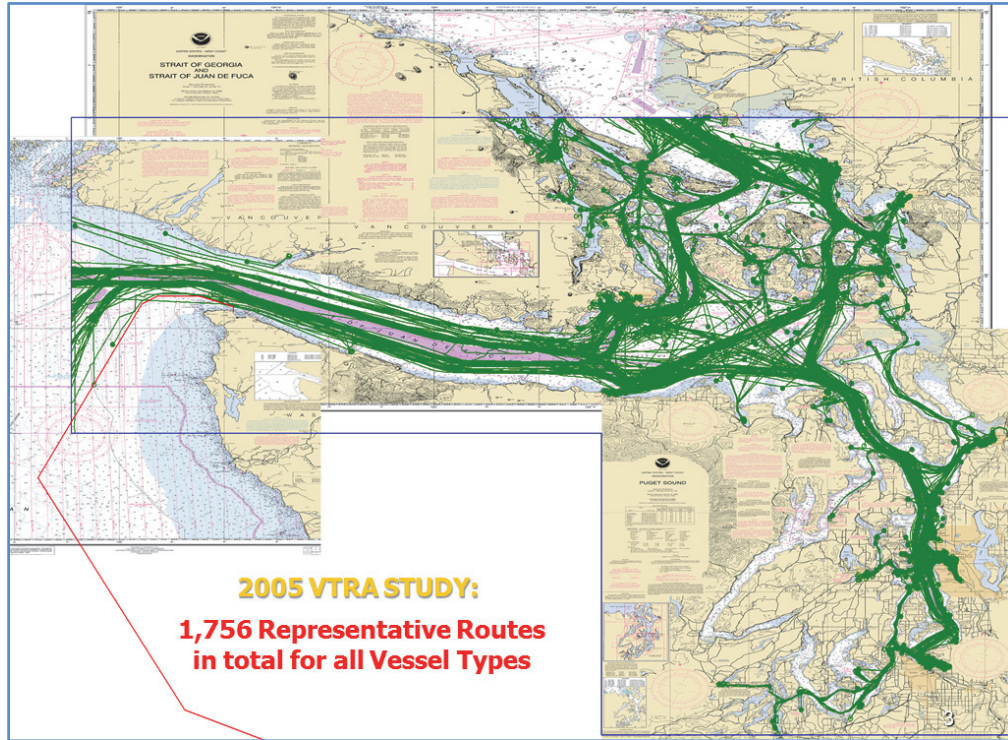

Figure 20. In total 1756 representative vessel route were constructed from 2005 VTOSS data during the 2005 VTRA to model the movement of VTS responding traffic in the GW/VCU MTS simulation model.

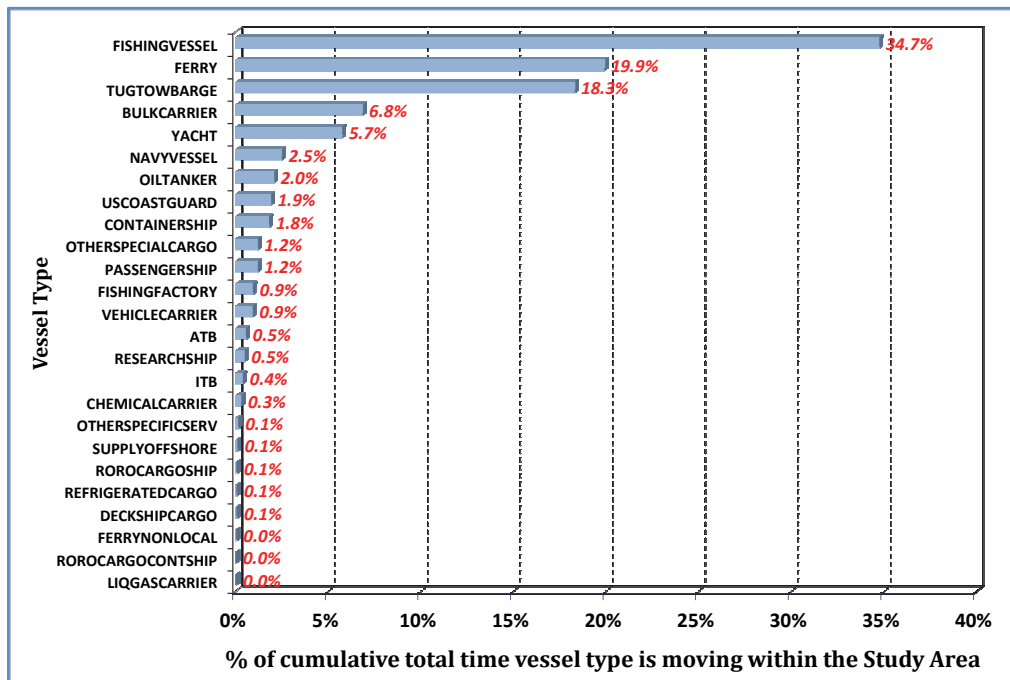

Figure 21. Tornado diagram displaying the cumulative percentage of time a vessel of a certain type is moving with the study area in the 2005 VTRA model over the course of one simulation year.

FINAL REPORT: VTRA 2010

For example, only 22 representative routes were utilized to model container traffic ($\approx 2\%$ of all traffic, see Figure 21) and 47 to model bulk carrier traffic ($\approx 7\%$ of all traffic, see Figure 21). The specific routes for container vessels and bulk carriers in the 2005 VTRA are depicted in Figure 22. A relative large number of representative routes was selected in modeling oil tanker traffic during the 2005 VTRA since oil tankers were part of the FV group in that study, whereas container vessels and bulk carriers were considered Interacting Vessels (IV's), not FV's.

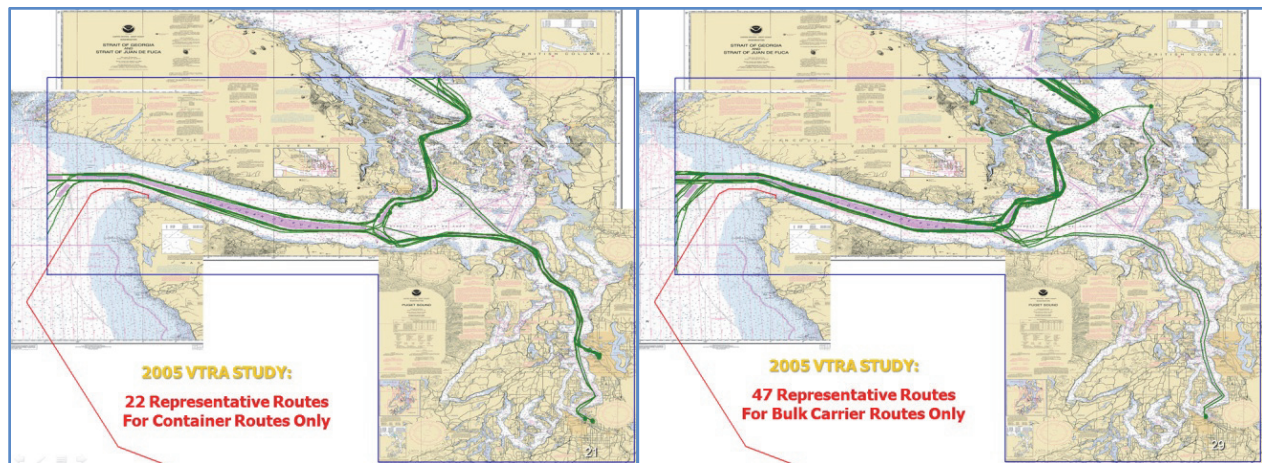

Figure 22. In total 22 (47) representative vessel route were constructed from 2005 VTOSS data during the 2005 VTRA to model the movement of container vessel (bulk carrier) traffic in the GW/VCU MTS simulation model.

To allow for inclusion of container vessel and bulk carriers in the focus vessel group for further analyses with the GW/VCU VTRA model, it would appear that a higher number of routes for these vessel types would be desirable. To that end, a modeling decision was made in updating the 2005 VTRA model to 2010 VTOSS data to attempt to retain a vessel's individual route throughout its transit rather than resorting to representative routes by vessel type. In that manner, FV group selection is not affected by a route modeling approach.

Algorithmic cleaning of VTOSS 2010 data

The VTOSS 2010 data consists of a set of waypoints of vessels along with identifying information about the vessel and the VTS center that collected the data point. Since 2005, VTOSS also added a trip identification number that indicates a set of waypoints for a particular vessel transiting through one VTS center's area. However, each VTS center assigns a different trip identification number to a vessel as it transits through the system leaving route segments and not complete routes. In addition, frequent alternative spellings of vessel names were observed. Once the vessel names were disambiguated, as many route segments as possible were connected algorithmically to make complete routes of vessels transiting the system. Figure 23 shows the result of

algorithmically connecting route segments and depicts the remaining modeling challenges alluded to previously. Needless to say, remaining errors are apparent in Figure 23.

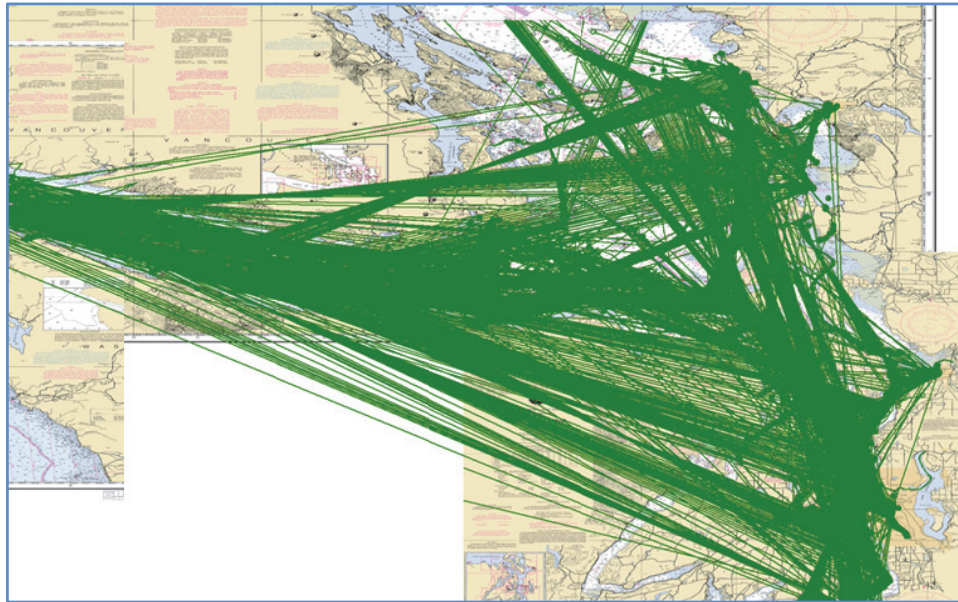

Figure 23. Route plots of the VTOSS 2010 data after algorithmically joining route segments.

Multiple VTOSS data phenomena cause the errors observed in Figure 23. Firstly, the time of collection of each waypoint is recorded in the VTOSS data and is used to sort the waypoints in order to form a route. The time is recorded using a 24 hour clock, but points occurring in the hour after midnight are frequently recorded as *12:xx* instead of *00:xx*. This causes the points recorded as *12:xx* to be a mixture of the vessel's location after midnight and after midday, causing the route to zigzag back and forth as shown in Figure 24. Another problem was caused by pieces of a route not being recorded by VTOSS, leaving non-contiguous pieces of a route connected by a straight line. In yet other cases, the same VTS center can assign a new identification number half way through a vessel's transit through their waters. Also simple errors were observed in identifying the location of the vessel as shown in Figure 25.

Additional algorithms were developed to remove a large proportion of the data inaccuracies depicted in Figure 23, Figure 24 and Figure 25. These algorithms were also designed to reduce the size of the VTOSS dataset by removing intermediate points when a vessel was in fact moving in a straight line. Once developed, these algorithms took one month to run on the approximately 50GBs of VTOSS 2010 data on a MacBrook Pro with a 2.7 Ghz Intel Core i7, 16 GB of 1600 Mhz DDR3 RAM, and 768GB SSD hard drive.

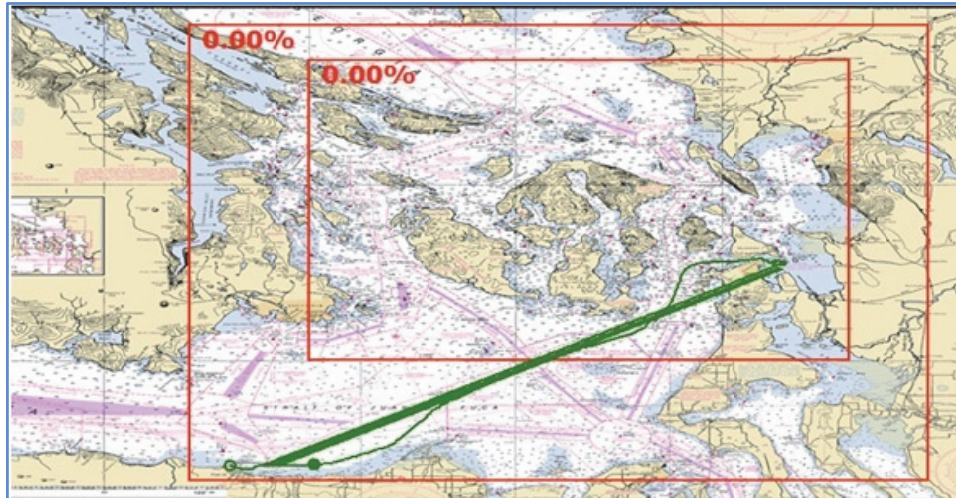

Figure 24. A route affected by the time problem after midnight in the VTOSS 2010 data.

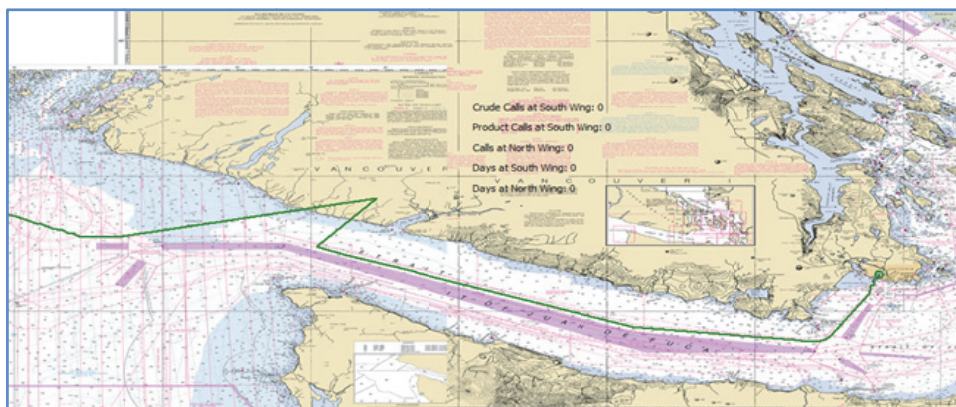

Figure 25. A route affected by problems identifying the correct location of the vessel.

Manual cleaning of VTOSS 2010 data

Unfortunately, as shown in Figure 26's left panel not all data inaccuracies can be resolved mathematically and removed algorithmically. Despite algorithmically cleaning the VTOSS 2010 data to construct contiguous routes for a single transit, some route segmentation remains. Algorithmic cleaning of oil tanker routes resulted in 2,345 route segments for oil tankers (see left panel of Figure 26). Observe from Figure 26's left panel that following algorithmic cleaning only, oil tanker routes segments still display errors as a result of electronic transmission problems when recording a vessel transit in the VTOSS data. To further correct for those errors these 2345 route segments were manually cleaned resulting in 2328 route segments for oil tankers depicted in Figure 26's right panel using the VTOSS 2010 dataset. Recall that during the VTRA 2005 analysis a total of 1756 representative routes were constructed for all vessel types.

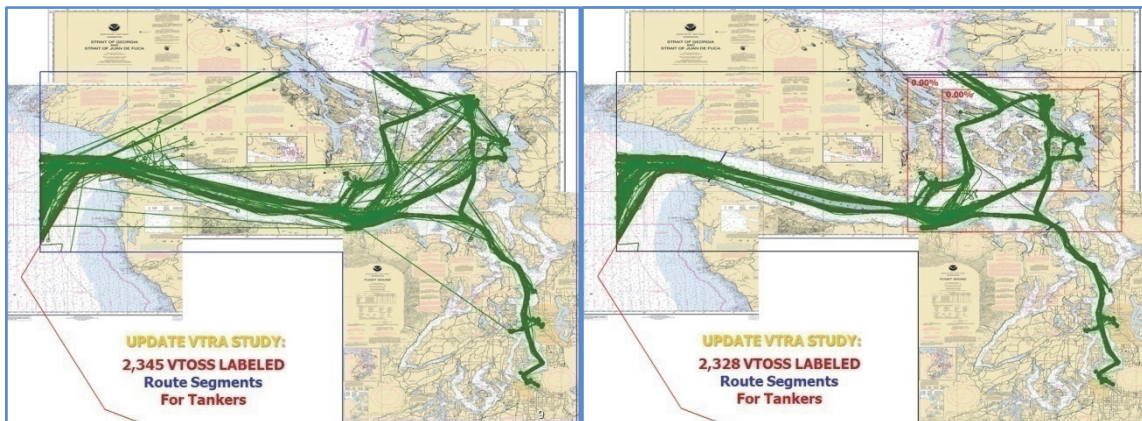

Figure 26. Left panel: 2,345 route segments after algorithmic cleaning of oil tanker routes. Right panel: 2328 route segments following manual cleaning of tankers routes following algorithmic cleaning.

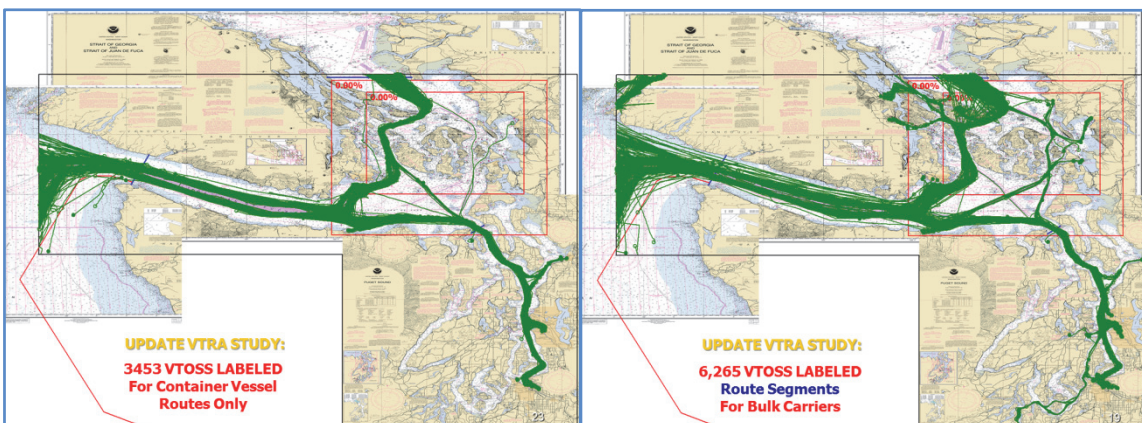

Figure 27. Left panel: 3,453 route segments after algorithmic and manual cleaning of container vessel routes. Right panel: 6265 route segments following algorithmic and manual cleaning of bulk carrier routes.

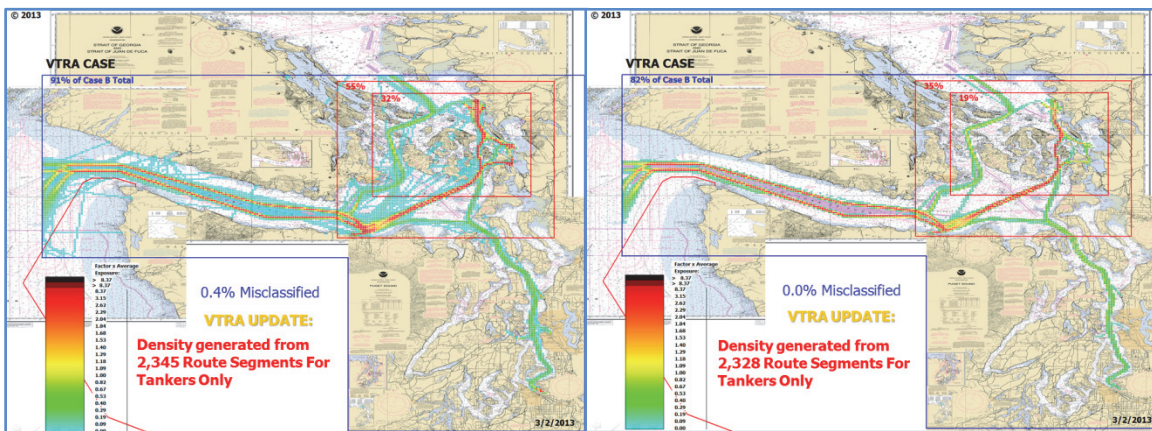

Figure 28. Left panel: Oil density tanker geographic profile generated using left panel routes in Figure 26. Right panel: Oil density tanker geographic profile generated using right panel routes in Figure 26.

Comparing Figure 26's right panel with Figure 11 one observes a larger dispersion of oil tanker routes in of Figure 26 than in Figure 11. The same observation can be made when comparing the algorithmically and manually cleaned routes for container vessels and bulk carriers in Figure 27 using VTOSS 2010 data, with the representative routes depicted in Figure 22 for these vessel types in the 2005 VTRA. In total, following algorithmic cleaning only of VTOSS 2010 data to construct route segments by vessel type, 79,500 route segments remained. Needless to say, it would simply be too time consuming to subject all these route segments to a manual cleaning process. Instead, it is suggested to manually clean routes, as demonstrated in Figure 26 for oil tankers and for those vessel types that are selected to be in a FV group. In anticipation of the inclusion of container vessels and bulk carriers in a FV group for scenario analyses their routes were manually cleaned as depicted in Figure 27.

Figure 28's left panel plots a route density for oil tankers generated using only the algorithmically cleaned routes displayed in Figure 26's left panel. Figure 28's right panel plots a route density for oil tankers using the both algorithmically and manually cleaned routes depicted in Figure 26's right panel. In Figure 28's left panel 99.6% of the tankers movements have a waterway zone (see Figure 28) assigned, whereas in its right panel 100% of tanker movements have a waterway zone assigned. In plotting this density, vessel movements that have no assigned waterway zone are not plotted. Figure 29 plots a graphic of the fifteen waterway zone definitions to be used in the updated GW/VCU MTS model.

The waterway zones ATBA (2), Islands Trust (10), San Juan Islands (11), Saragota Skagit (12) and Tacoma were added as separate zones in the updated VTRA model. The location ATBA (2) was assigned an equivalency of the WSJF (3) zone for the purposes of accident probability model, whereas the other added zones were assigned an equivalency with the Guemes Channel zone. The expansion of the number of waterway zones to accommodate an analysis for a larger class of focus vessels also required an expansion of the shoreline definition. The updated and expanded shoreline definition used in the VTRA 2010 model is depicted in Figure 30. Both the Department of Ecology and Puget Sound Pilots provided feedback on the shoreline definition in Figure 30, which plays an instrumental role in the analysis of POTENTIAL grounding frequencies.

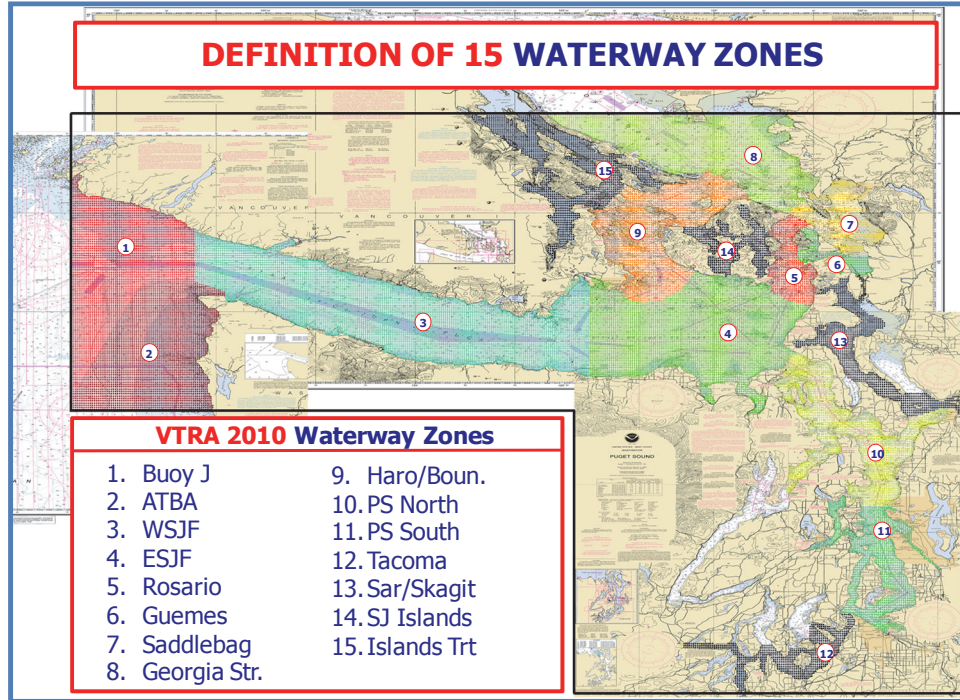

Figure 29. Waterway zone definitions used for the update of the GW/VCU MTS simulation from VTOSS 2005 to VTOSS 2010 data.

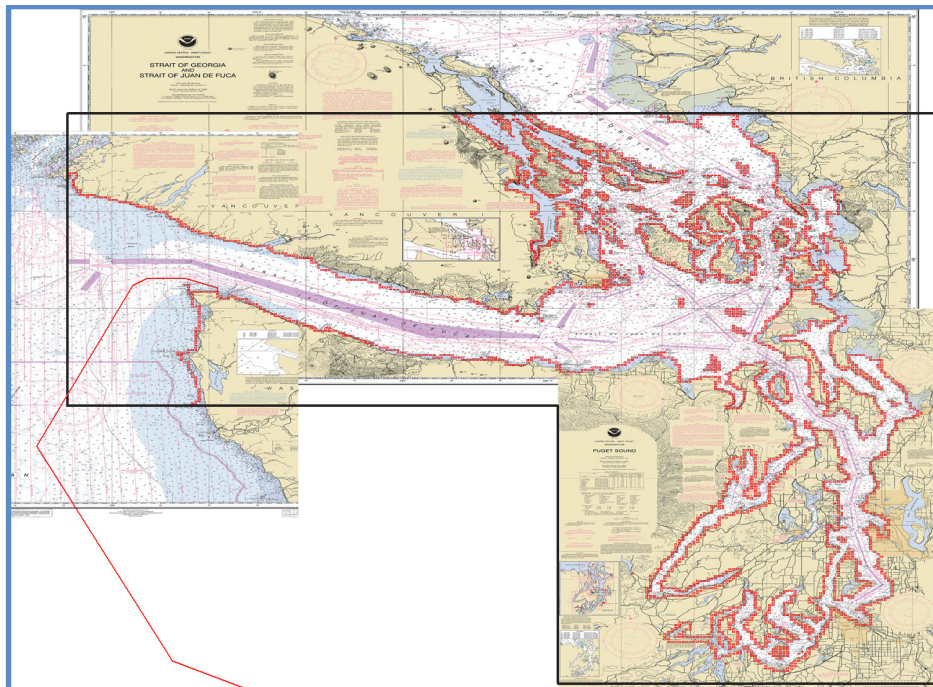

Figure 30. Expanded and revised shore line definition in VTRA 2010 model

FINAL REPORT: VTRA 2010

Vessel master type definition

Table 3 shows a sample list of vessel names in the VTOSS 2010 data for which different vessel types are assigned. The number of route segments for each alternative vessel type is provided in the second columns. An examination of Table 3 reveals different vessel types that are commonly assigned to the same vessel name.

Some of the entries in Table 3 will indeed refer to different vessels that share the same name. In that case the different vessel types may be correctly assigned to the same vessel name. One suggestion to differentiate between vessels sharing the same name is to use Lloyd's identification numbers or other vessel identification numbers. Unfortunately, these identification numbers are not consistently entered across the three VTS centers Seattle, Tofino and Victoria providing the data for the VTOSS datasets. Thus, complete disambiguation of vessel names to vessel types is not possible.

Further examination of Table 3 also reveals vessel names that are assigned similar vessel types. Frequent groups of vessel types assigned to the same vessel names are:

1. Tanker and chemical carrier.
2. Ferry, non-local ferry, and passenger vessel.
3. Passenger vessel and yacht.
4. Container, bulk carrier, deck ship cargo, other special cargo, ro-ro cargo ship, ro-ro cargo container ship, vehicle carrier.
5. Research ship and other specific service vessel.

These similar classifications may also have been used differently across the three different VTS centers included in VTOSS 2010 dataset. To allow for this similar misclassification of vessel types, the vessel master type definition in Table 4 is introduced for the 26 vessel types in the VTOSS data sets. Observe from Table 4 that the vessel types in the first entry in the list above are counted as tankers, the second and third entries as passenger vessels, the fourth entry as cargo vessels, and the fifth entry as service vessels. This allows for meaningful comparisons between the VTOSS 2005 dataset and VTOSS 2010 dataset that are not affected by these similar vessel type misclassifications.

Misclassification of vessel types described above was also observed in the VTOSS 2005 data. However, about twice the number of route segments was involved as compared to the VTOSS 2010 dataset. Moreover in the VTOSS 2005 set misclassification across the vessel master type definitions in Table 4 were observed as well. For example, Table 5 shows a sample in the VTOSS 2005 dataset of cargo vessels that were sometimes classified as passenger vessels. Observe that in Table 5 that 50 transits (or route segments) were classified as passenger vessels when they should have been classified as cargo vessels. Moreover, in the VTOSS 2005 dataset route segments of vessels classified as passenger vessels were observed that did not have route segments

FINAL REPORT: VTRA 2010

classified as cargo vessels, but turned out to be cargo vessels when researched further. This problem was not apparent in the VTOSS 2010 data.

Table 3. A sample list of vessel names that are designated as different vessel types in VTOSS 2010

Vessel Name	# Route Segments	Vessel Type	Vessel Name	# Route Segments	Vessel Type
ABAKAN	3	BULK CARRIER	ALEXANDRIA BRIDGE	1	BULK CARRIER
ABAKAN	2	OTHER SPECIAL CARGO	ALEXANDRIA BRIDGE	2	CONTAINER SHIP
ADMIRAL PETE	22	FERRY (NONLOCAL)	ALIOTH LEADER	1	OTHER SPECIAL CARGO
ADMIRAL PETE	3	PASSENGER SHIP	ALIOTH LEADER	2	VEHICLE CARRIER
ADRIA ACE	1	OTHER SPECIAL CARGO	ALJALAA	3	CHEMICAL CARRIER
ADRIA ACE	2	VEHICLE CARRIER	ALJALAA	1	OIL TANKER
ADVENTURE	3	FISHING VESSEL	ALPINE PENELOPE	4	CHEMICAL CARRIER
ADVENTURE	1	YACHT	ALPINE PENELOPE	15	OIL TANKER
AGEAN LEADER	4	OTHER SPECIAL CARGO	ALUMINATOR	14	FISHING VESSEL
AGEAN LEADER	4	VEHICLE CARRIER	ALUMINATOR	2	TUG TOW BARGE
AFFINITY	5	CHEMICAL CARRIER	AMBA BHAVANEE	3	CHEMICAL CARRIER
AFFINITY	2	OIL TANKER	AMBA BHAVANEE	3	OIL TANKER
AKEMI	3	FISH(ING) FACTORY	AMERICAN BEAUTY	3	FISH(ING) FACTORY
AKEMI	1	FISHING VESSEL	AMERICAN BEAUTY	1	FISHING VESSEL
ALASKAN LEGEND	43	OIL TANKER	AMERICAN HIGHWAY	1	OTHER SPECIAL CARGO
ALASKAN LEGEND	1	YACHT	AMERICAN HIGHWAY	1	VEHICLE CARRIER
ALEUTIAN BEAUTY	2	FISH(ING) FACTORY	AMERICAN NO. 1	4	FISH(ING) FACTORY
ALEUTIAN BEAUTY	1	FISHING VESSEL	AMERICAN NO. 1	1	FISHING VESSEL
ALEUTIAN LADY	1	FISH(ING) FACTORY	AMETHYST ACE	3	OTHER SPECIAL CARGO
ALEUTIAN LADY	1	FISHING VESSEL	AMETHYST ACE	1	VEHICLE CARRIER
ALEX GORDON	5	SUPPLY (OFFSHORE)	AMY USEN	1	FISH(ING) FACTORY
ALEX GORDON	4	TUG TOW BARGE	AMY USEN	6	FISHING VESSEL
ALEXANDRIA BRIDGE	1	BULK CARRIER	ANDES	1	CHEMICAL CARRIER
ALEXANDRIA BRIDGE	2	CONTAINER SHIP	ANDES	1	OIL TANKER

Table 4. Master vessel type definition for the 26 VTOSS vessel type classification used in the GW/VCU MTS simulation model.

#	VESSEL TYPE	MASTER TYPE	#	VESSEL TYPE	Master Type
1	BULKCARRIER	Cargo	14	PASSENGERSHIP	Passenger
2	CHEMICALCARRIER	Tanker	15	REFRIGERATEDCARGO	Cargo
3	CONTAINERSHIP	Cargo	16	RESEARCHSHIP	Service
4	DECKSHIPCARGO	Cargo	17	ROROCARGOSHIP	Cargo
5	FERRY	Passenger	18	ROROCARGOCONTSHIP	Cargo
6	FERRYNONLOCAL	Passenger	19	SUPPLYOFFSHORE	Service
7	FISHINGFACTORY	Fishing	20	TUGTOWBARGE	Tugtow
8	FISHINGVESSEL	Fishing	21	UNKNOWN	Service
9	LIQGASCARRIER	Tanker	22	USCOASTGUARD	Service
10	NAVYVESSEL	Cargo	23	VEHICLECARRIER	Cargo
11	OILTANKER	Tanker	24	YACHT	Passenger
12	OTHERSPECIALCARGO	Cargo	25	ATB	Tanker
13	OTHERSPECIFICSERV	Service	26	ITB	Tanker

Table 5. Cargo vessels that were classified as passenger vessels in the VTOSS 2005 dataset

Vessel Name	Cargo Transits	Passenger Transits	Vessel Name	Cargo Transits	Passenger Transits
BRIGHT STATE	15	3	MIDNIGHT SUN	8	3
BRIGHT STREAM	16	7	MORNING MELODY	3	2
CAPE HORN	7	5	NORTH STAR	4	4
DONG FANG GAO SU	2	2	REINA ROSA	3	3
GREAT LAND	3	4	SKAUBRYN	17	6
IGARKA	3	3	SKAUGRAN	18	2
IVORY ARROW	4	2	UNITED SPIRIT	5	4
Total	50	26	Total	58	24

Comparing representative routes approach to the route segment approach

The fifth column in Table 6 provides by vessel master type the percentage of time that a waterway zone is assigned to a vessel movement for the GW/VCU MTS simulation model using VTOSS 2005 data. Similarly, the fifth column in Table 7 provides by vessel master type the percentage of time that a waterway zone is assigned to a vessel movement for the updated GW/VCU MTS simulation model using VTOSS 2010 data. Recall Table 4 provides the vessel master type definition used in the generation of Table 6 and Table 7 for the 26 vessel types in the VTOSS data sets. These percentages (in Table 6 and Table 7) are evaluated by dividing the number of minutes per year a vessel is moving within the MTS simulation with a waterway zone assigned by the total number of minutes a vessel is moving (see the third and fourth columns in Table 6 and Table 7).

Table 6. Route and density data for 6 vessel master types generated using the GW/VCU MTS simulation model with 2005 VTOSS data and location definitions in Figure 29.

Vessel Master Type	# Represent. Routes	# Minutes per Year	# Minutes per year No Location	% Time Location Assigned	% of Traffic	Average # Vessels
Cargo	106	5344799	6821	99.9%	13.7%	10.2
Tanker	164	1313096	444	100.0%	3.4%	2.5
TugTow	1185	7272609	17925	99.8%	18.7%	13.8
Service	5	1039769	942	99.9%	2.7%	2.0
Passenger	164	9701338	54771	99.4%	25.0%	18.5
Fishing	132	14201790	64223	99.5%	36.5%	27.0
Total	1756	38873401	145126	99.6%	100.0%	74.0

FINAL REPORT: VTRA 2010

Table 7. Route and density data for 6 vessel master types generated using the updated GW/VCU MTS simulation model with 2010 VTOSS data and location definitions in Figure 29.

Vessel Master Type	# Represent. Routes	# Minutes per Year	# Minutes per year No Location	% Time Location Assigned	% of Traffic	Average # Vessels
Cargo	14640	7468850	51583	99.3%	18.5%	14.2
Tanker	3340	1287457	2838	99.8%	3.2%	2.4
TugTow	40704	7927747	171967	97.8%	19.7%	15.1
Service	2458	614972	6730	98.9%	1.5%	1.2
Passenger	14521	9090031	40756	99.6%	22.6%	17.3
Fishing	3837	13920520	68899	99.5%	34.5%	26.5
Total	79500	40309577	342773	99.1%	100.0%	76.7

The second column in Table 6 and Table 7 provides the number of route segments and representative routes used in the GW/VCU MTS simulation model using VTOSS 2005 and VTOSS 2010 data respectively. Although a slightly higher accuracy is observed in the fifth column in Table 6 (2005) compared to the fifth column in Table 7 (2010), a definite improvement in vessel route dispersion is observed by going from Figure 22 (2005) to Figure 27 (2010) for container vessels and bulk carriers. Thus by retaining a vessel's individual route using the VTOSS 2010 data, vessel movements in the updated GW/VCU MTS simulation are more representative than the former GW/VCU MTS model using the 2005 VTOSS dataset. The percentage of total moving traffic by vessel master type, depicted in the sixth columns in Table 6 and Table 7, are evaluated by dividing the number of minutes in the third columns by the total sum of the third column. The average number of moving vessels by master type at any arbitrary point in time is evaluated by dividing the minutes in the third column in Table 6 and Table 7 by the total number of minutes in a calendar year. Thus in Table 6 (2005) the GW/VCU MTS model evaluated an average of 74.0 moving vessels in the system at any arbitrary point in time, whereas in Table 7 (2010) an average of 76.7 vessels was evaluated.

To illustrate the fluctuation in the number of vessels moving in the study area over a calendar year, however, Figure 31 plots the time series (every 15 minutes) of the number of vessels excluding ferries, yachts and fishing vessels for the GW/VCU MTS simulation model using VTOSS 2005 and VTOSS 2010 data. Figure 32 on the other hand plots this time series comparison for ferries, yachts and fishing vessels. Both Figure 31 and Figure 32 serve as a reminder that “the world is not average” and that vessel risk, of which number of vessels moving in the system is a driver, is not a constant but a dynamic quantity that changes over time. The larger goal of vessel risk management is to reduce the overall average risk level while managing the variation of the time series of risk by avoiding “high” risk spikes.

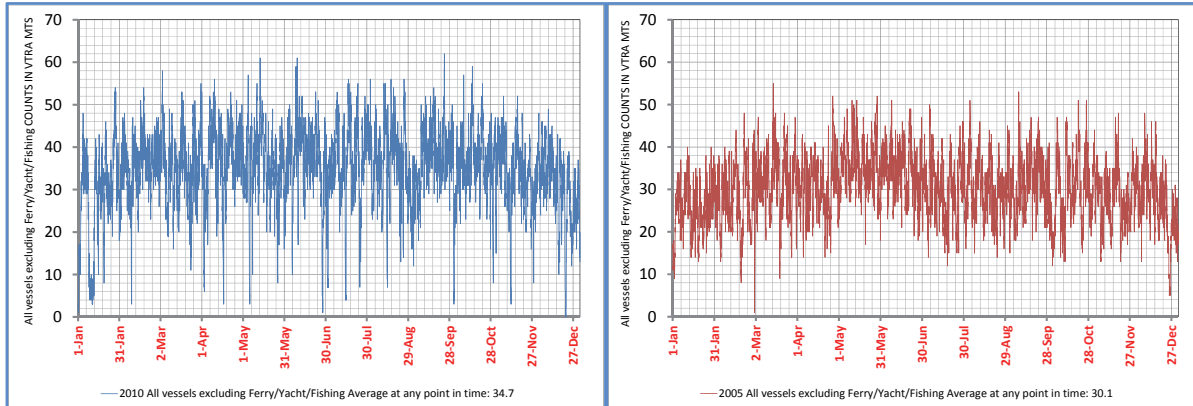

Figure 31. Left panel: Time series of counts of all vessels excluding ferries, yachts and fishing vessels in the system for the GW/VCU MTS simulation model using the VTOSS 2010 dataset; Right panel: Same using the VTOSS 2005 dataset.

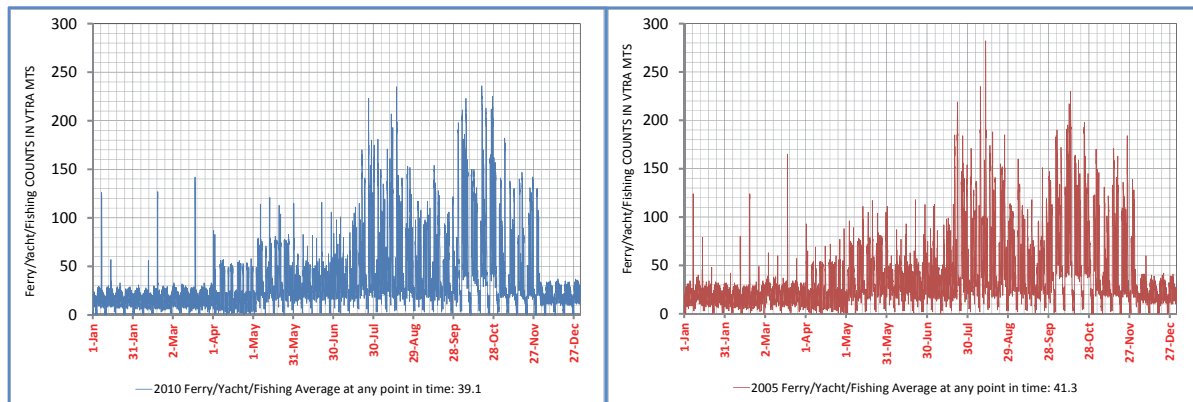

Figure 32. Left panel: Time series of counts of all ferries, yachts and fishing vessels in the system for the GW/VCU MTS simulation model using the VTOSS 2010 dataset; Right panel: Same using the VTOSS 2005 dataset.

Moving from Sampled Speeds to Calculated Speeds

As discussed in Section 2, the VTRA 2005 simulation sampled speeds from the distribution of all vessel speeds of a given type of vessel in the 2005 VTOSS database. So a given container vessel may actually transit at the speed of another container vessel in the database. The vessel also transited along a representative route for all vessels of that type traveling between its departure and destination points. In the VTRA 2010 simulation, the vessel travels along its own route and we have the start time and the end time for that transit in the 2010 VTOSS database. Figure 33 shows one such route for the Westwood Rainier cargo vessel. In the VTRA 2010 simulation, we calculate the length of the route, so we can calculate the average speed of the vessel on that transit. The Westwood Rainier started its transit at 8:58 pm on January 1st, 2010 and ended its transit the next morning at 8:09 am. The transit took 11 hours and 11 minutes and was calculated (after the route cleaning discussed above) to be 157.26 nautical miles. This means the vessel averaged 14.06 knots

over the transit. The Westwood Rainier has a maximum speed of 16.1 knots and an average speed of 14.1 knots (according to www.marinetraffic.com), so this calculation appears quite accurate.

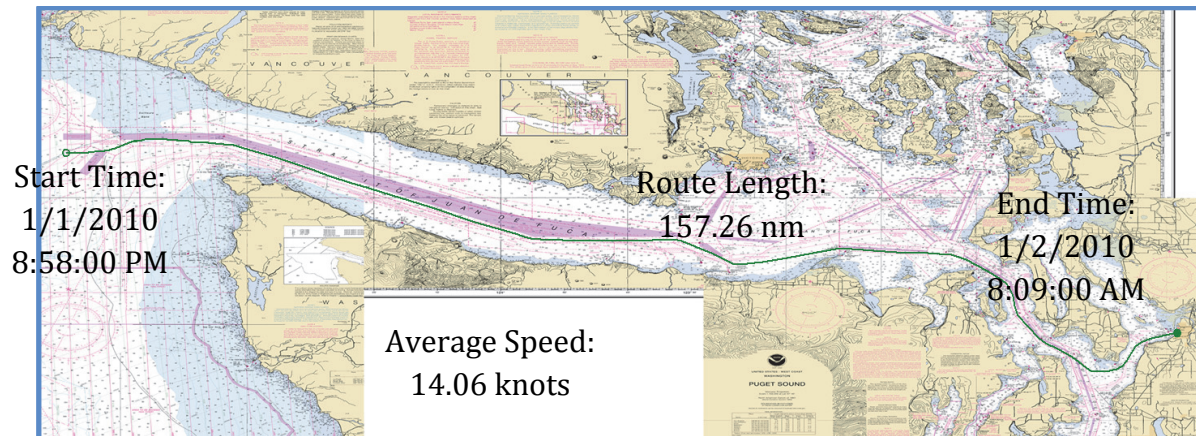

Figure 33. A route followed by the Westwood Rainier cargo vessel and its calculated average speed.

One must consider, however, that the vessel would have slowed around the pilot station and as it approached dock, so it would not have moved at this average speed throughout the transit. It also had moderately strong currents in the direction it traveled throughout the entire transit, so it would have made more than 14.1 knots for other parts of the transit. Thus, we must start the simulated transit at a higher speed and then reduce the speed based on the location of the vessel and the traffic rules (one-way zones, pilot station, approaching dock, etc.). For each transit, we calculated a speed accuracy factor by taking the simulated length of the transit using the average speed as the starting point and divided by the length of the transit in the 2010 VTOSS database. We calculated speed calibration multipliers for each vessel type to ensure that the speed accuracy factor was as close to 1 as possible.

Figure 34 shows the overall distribution of the speed accuracy factor for all vessels once the speed calibration multipliers were used for the initial speed of the vessel. The mean is 1.0003 with a 95% confidence interval of [0.9995,1.0012]. It is not possible to achieve a value of 1 as each change to the speed calibration factors can change the dynamics of the system, but the calculations are accurate on average to four decimal places. This does not mean that every transit is accurate to four decimal places. However, only 10% had a speed accuracy factor below 0.9 and only 10% had a speed accuracy factor over 1.1. Speeds that were clearly inaccurate based on the VTOSS data were sampled from the original speed distributions. Thus, we could accurately model the actual speed for a given transit and only sample general vessel type speeds for a few transits.

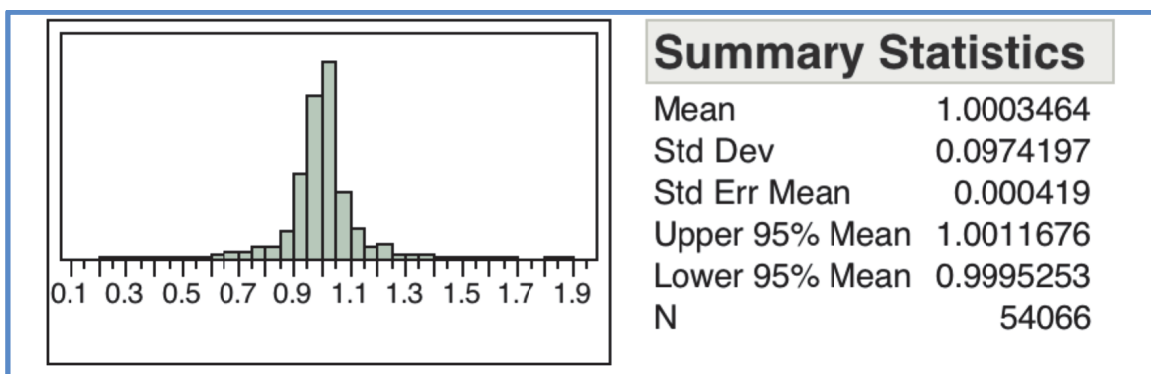

Figure 34. The distribution of the speed accuracy factor for all transits..

Extending VTRA 2005 incident and accident probability models

During the VTRA 2005 accident probability models given the occurrence of an incident (mechanical or human error) were developed separately for tankers and ATB's. Mechanical incidents considered were; propulsion, steering and navigational aid failures. To accommodate the expansion of the focus vessel class to include also bulk carriers, container vessels, chemical carriers and oil barges, the tanker accident probability models were utilized for the container vessels, bulk carriers and chemical carriers, whereas the ATB models were utilized for oil barges.

In the VTRA 2005 annualized historical mechanical incident data was collected for the tankers and ATB's that visit the cherry point terminal and were carefully vetted incident by incident. A factor 3 was applied to account for human error incidents, which was based on the observation that out of 4 accidents three had a human error as their immediate cause. The VTRA 2005 simulation model incident rates were calibrated to the annualized statistics and converted to an incident rate per unit time on the water, taking advantage of the VTRA 2005's model capability of distinguishing short routes from long ones while taking into account vessel speeds as well.

While incident data was collected for freighters as a vessel class during the VTRA 2005, it was not broken down by container, bulk carrier or any of the other 5 cargo vessel types and was not as carefully vetted as the incident data for tankers and ATB's. Hence, to accommodate the expansion to a larger focus vessel class we assumed that the incident rates by unit time on the water for tankers also apply to the container, bulk carrier and other cargo vessel class while taking into account the amount of travel time of each vessel class in the VTRA 2010 model. Figure 35A displays the incident rates by moving hour and demonstrates that bulk carriers, container ships, other cargo vessels and chemical carriers are assigned the incident rates for tankers, whereas the oil barge class are assigned the incident rates for ATB's.

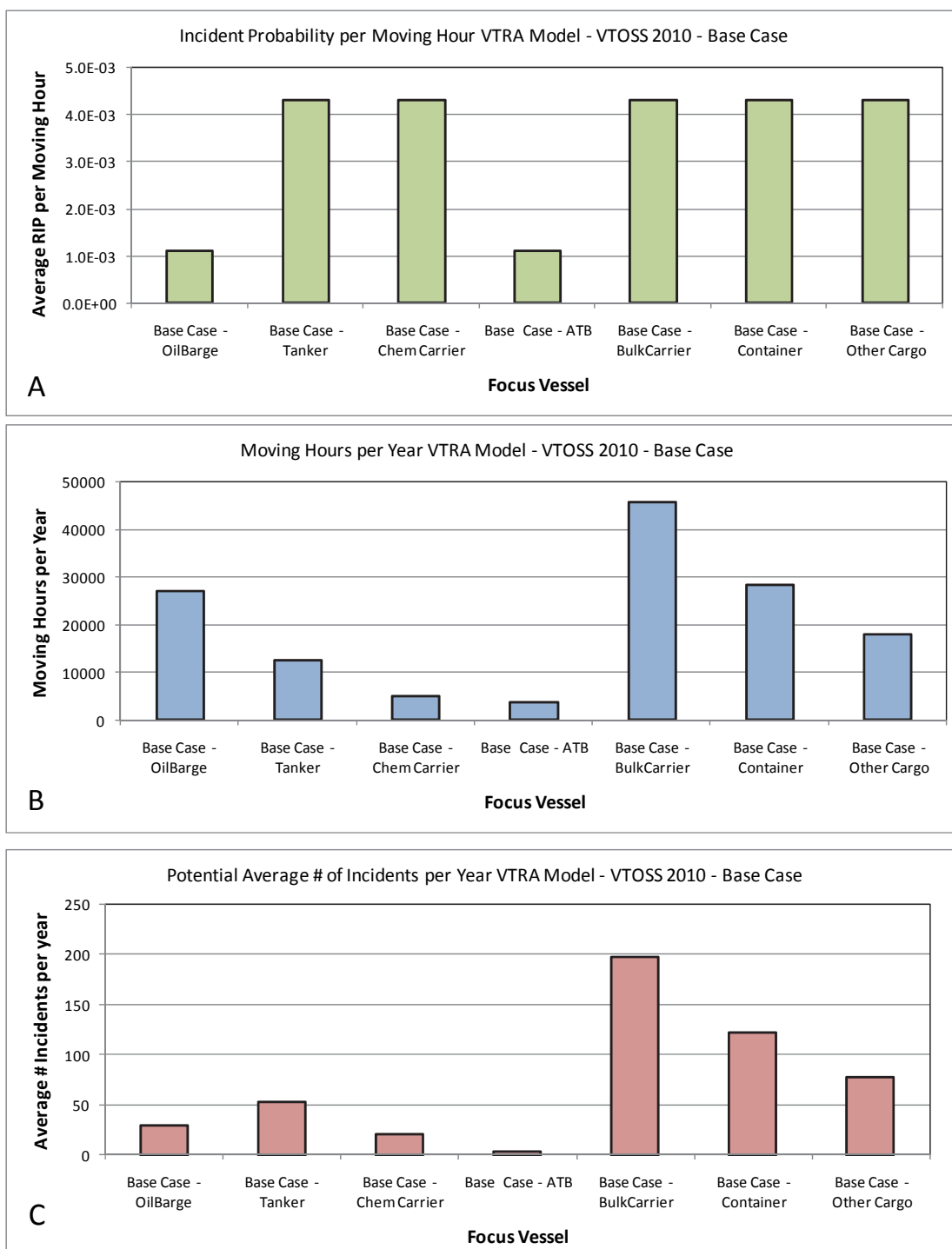

Figure 35. A: Incident rate per moving hour by focus vessel; B: Moving hours in VTRA 2010 model by focus vessel; C: Potential number incidents per year by focus vessel

FINAL REPORT: VTRA 2010

Figure 35 further visualizes the effect of these assumptions on the annualized incident rates by vessel category. Combining the incident rates per moving hour (Figure 35A) with the amount of moving hours per year (Figure 35B) in the VTRA 2010 model, results in the potential average number of incidents per year as depicted in Figure 35C. Observe from Figure 35C that the bulk carrier class has the largest potential number of incidents per year in the VTRA 2010 model which is primarily driven by the fact that the largest portion of the focus vessel traffic in the VTRA study area are in fact bulk carriers.

Oil carrying assumptions for focus vessels

Of the tank focus vessels, tankers and chemical carriers are identified in the vessel type record in VTOSS. ATBs and ITBs are not specifically identified, but there are a limited number of them, so they can be identified by name. However, oil barges are only listed as a tug tow barge in VTOSS. The records for tugs sometimes indicate the barge type as bulk cargo, derrick, light, log barge, petroleum, or wood chip. However, a blank record can either mean there is no barge or that the data was not recorded by the VTOSS. To identify oil barges, we collected the list of all tug names that were listed as towing a petroleum barge at some point in 2010. These names were then provided to the Puget Sound Pilots who indicated whether they were exclusively used for petroleum based on their extensive knowledge of vessels in the study area. They were also asked to identify other tugs that were exclusively used for petroleum. In this manner, we could use the non-blank VTOSS records to identify the tug's barge and use the Puget Sound Pilot's information to identify oil barges with blank records. While during the VTRA 2005 some tankers will still of the single hull type, in the VTRA 2010 analysis all tankers, ATB's and oil barges are of the double hull design. Moreover fuel tanks of 40% of cargo focus vessels are assumed double hull protected, whereas the remainder of the cargo focus vessel fuel tanks are single hull protected.

The culmination of the oil barge movement modeling effort is depicted in Figure 36 and Figure 37. Please observe from Figure 36 that oil barge movement modeling in the VTRA 2010 model accounts for about 54.5% of the movements of all tank focus vessels. The predominant movement of oil barges is a north south movement between the Cherry point, Ferndale and Anacortes refineries and the southern Puget Sound. However, quite a significant number of oil barges travel north and south to Canada. A lesser density is observed entering/leaving the Strait of Juan de Fuca.

Unfortunately, no information is collected within the VTOSS 2010 data set regarding the volume of cargo oil or type of cargo oil on board a particular tank vessel. While vessel traffic density movement tends to be a driver of accident frequency analysis, the oil that vessel carry tends to be a driver for oil outflow analysis. To represent oil movement within the VTRA 2010 model we have had to therefore rely on set of overarching assumptions regarding the amount and type of oil that moved through the study area by vessels. These assumptions were made based on interactions

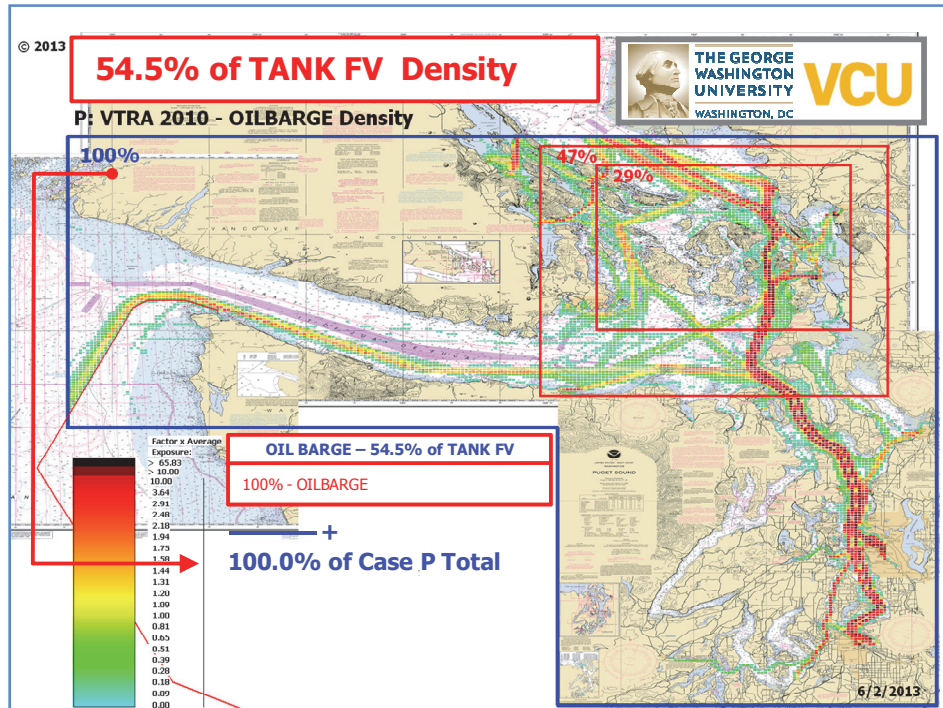

Figure 36.2D Traffic density of tugs towing/pushing oil barges in the VTRA 2010 model.

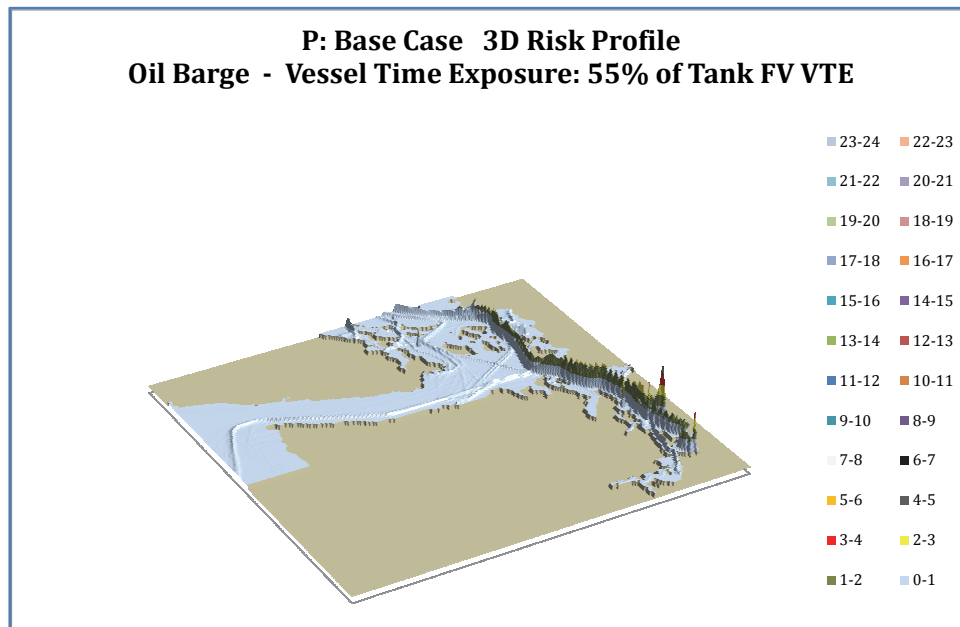

Figure 37. 3D Traffic density of tugs towing/pushing oil barges in the VTRA 2010 model.

FINAL REPORT: VTRA 2010

with the VTRA 2010 Steering Committee and other stakeholders over the course of the study and are listed below.

List of oil carrying assumptions in VTRA 2010 model:

1. Tankers are classified as crude or product carriers by name
2. Chemical carriers transport product
3. Oil barges are assumed to transport product
4. Focus vessels fuel tanks are 50% full
5. US bound crude tankers are assumed fully laden as they arrive in study area and drop of equal amounts at their stops and leave empty
6. Canadian bound crude tankers are assumed empty as they arrive and fully laden as they depart
7. Product tankers and ATB's are assumed fully laden as they depart study area, empty as they arrive
8. Chemical carriers are assumed fully laden as they arrive in the study area, empty when they leave the study area
9. When ATB's go back and forth between two destinations within the study area they are assumed 50% full
10. Oil barges are assumed fully laden as they travel through study area
11. Tank focus vessels not covered by assumptions 1-10 are assumed fully laden

Combined with a validated picture of vessel traffic and data recorded in the VTOSS 2010 dataset regarding vessel size in terms of dead-weight tonnage, we hope the set of assumptions above adds realism to the movement of oil throughout the VTRA study area. Such realism is important when comparing a Base Case scenario to another What-If traffic scenario in terms of oil spill transportation risk. The effect of these assumptions are summarized in separate geographic density profiles of product, crude and fuel movements which serve as a starting point of the VTRA 2010 potential oil loss analyses (see, Figure 51 - Figure 54).

THIS PAGE IS LEFT
INTENTIONALLY BLANK

4. VALIDATION OF 2010 VTOSS AND AIS 2010 CROSSING LINE DATA

AIS data is collected on a regular basis by the Marine Exchange Puget Sound (MXPS). Amongst other reports the Marine Exchange AIS system is able to produce crossing line count reports by cargo, tanker and passenger vessel at a line drawn on a nautical map. At our request, the MXPS produced these reports for three counting lines depicted in Figure 38 for the year 2010. Panel A, provides an overview look of the three counting lines, whereas Panels B, C and D provide a close-up view of these three counting lines separately. For the West Strait of Juan de Fuca line the crossing line count data separates eastbound and westbound traffic, whereas for the Georgia Strait and Puget Sound crossing lines count data is separated in north and southbound traffic as depicted in Panels B,C and D in Figure 38. Unfortunately, no AIS data is available for the year 2005 for the geographic area in Figure 38A.

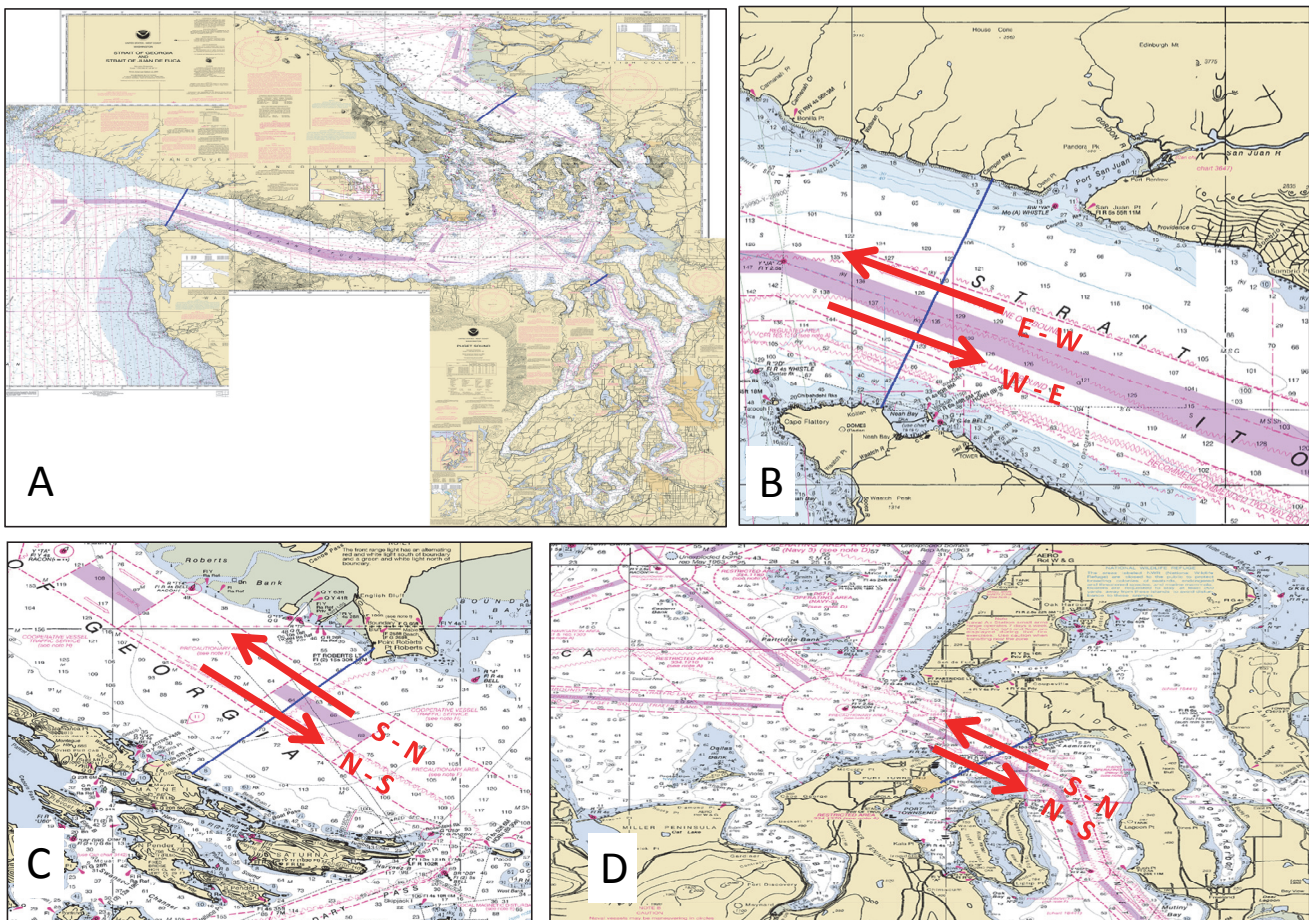

Figure 38. A: Overview of three AIS crossing definitions; B: Close-up view of crossing line at the West Strait of Juan de Fuca Entrance; C: Close-up view of crossing line at the George Strait entrance; D: Close-up view of the crossing line at the Puget Sound entrance.

FINAL REPORT: VTRA 2010

Crossing line analysis of AIS 2010 data.

Table 8 provides the AIS 2010 crossing line counts for the three crossing lines depicted in Figure 38. From Table 4 one observe that per this data source it appears more traffic traveled north bound at the Georgia Strait Entrance (100%) than south bound (85%). For the West Strait of Juan de Fuca and Puget Sound crossing lines one observe a much more even distribution with about the same amount of traffic travelling in both directions. Moreover, a larger amount of traffic crosses the WSFJ crossing line (8217 – 150%), followed by the Puget Sound crossing line (5639 – 103%) and Georgia Strait crossing line (5471 – 100%). Hence, approximately 50% more traffic crosses the WSFJ crossing line than the Georgia Strait crossing line, whereas only 3% more crosses the Puget Sound crossing line.

Table 8. AIS 2010 Crossing line counts by vessel types: cargo, tanker and passenger vessel. A: West Strait of Juan de Fuca crossing Line counts; B: Georgia Strait crossing Line counts; C: Puget Sound crossing line counts.

A: WSJF CROSSING LINE

Ship Type	East Bound	West Bound	Grand Total
Cargo	3216	3157	6373
Tanker	694	685	1379
Passenger	244	221	465
Grand Total	4154 - 100%	4063 - 98%	8217

B: GEORGIA STRAITE CROSSING LINE

Ship Type	North Bound	South Bound	Grand Total
Cargo	2278	2133	4411
Tanker	267	266	533
Passenger	414	113	527
Grand Total	2959 - 100%	2512 - 85%	5471

C: PUGET SOUND CROSSING LINE

Ship Type	North Bound	South Bound	Grand Total
Cargo	1754	1766	3520
Tanker	95	95	190
Passenger	958	971	1929
Grand Total	2807 - 100%	2832 - 101%	5639

Matching VTOSS 2010 Vessel Types to AIS 2010 Vessel Types.

The AIS crossing line counting feature depicted in Figure 38 was programmed into the VTRA 2010 simulation model to mimic the same counting procedure for each of the 26 different vessel type classifications listed in Table 4. Table 9 provides the crossing counts by vessel type and Table 10 by vessel master type as defined in Table 4 using the VTOSS 2010 dataset.

Table 9. GW/VCU MTS Crossing line counts using VTOSS 2010 data by 26 different vessel type classifications.

VESSEL TYPE	Master Type	TOT WSJF W-E	TOT WSJF E-W	TOT G_STR N-S	TOT G_STR S-N	TOT PS N-S	TOT PS S-N
BULKCARRIER	Cargo	1446	1493	1034	1023	300	309
CHEMICALCARRIER	Tanker	152	155	142	127	18	18
CONTAINERSHIP	Cargo	1045	1047	440	547	1004	994
DECKSHIPCARGO	Cargo	2	26	2	17	10	35
FERRY	Passenger	0	0	0	0	572	572
FERRYNONLOCAL	Passenger	1	5	1	3	423	450
FISHINGFACTORY	Fishing	83	117	20	51	108	133
FISHINGVESSEL	Fishing	3368	3330	227	220	320	329
LIQGASCARRIER	Tanker	2	4	0	0	0	0
NAVYVESSEL	Cargo	49	101	215	239	136	153
OILTANKER	Tanker	406	415	33	86	83	76
OTHERSPECIALCARGO	Cargo	251	253	334	166	102	4
OTHERSPECIFICSERV	Service	7	26	1	9	7	18
PASSENGERSHIP	Passenger	241	62	56	40	164	43
REFRIGERATEDCARGO	Cargo	0	5	0	22	15	27
RESEARCHSHIP	Service	35	51	1	6	42	45
ROROCARGOSHIP	Cargo	5	72	0	10	9	79
ROROCARGOCONTSHIP	Cargo	147	47	0	14	118	46
SUPPLYOFFSHORE	Service	0	5	0	2	33	27
TUGTOWBARGE	Tugtow	333	319	1201	1052	1631	1696
UNKNOWN	Service	0	0	0	0	0	0
USCOASTGUARD	Service	35	49	48	41	72	43
VEHICLECARRIER	Cargo	197	97	5	119	103	130
YACHT	Passenger	29	37	45	21	71	82
ATB	Tanker	58	74	45	48	34	35
ITB	Tanker	0	0	0	0	0	0
	Total	7892	7790	3850	3863	5375	5344

Table 10. GW/VCU VTRA model crossing line counts using VTOSS 2010 data by vessel master type.

Master Type	TOT WSJF W-E	TOT WSJF E-W	TOT G_STR N-S	TOT G_STR S-N	TOT PS N-S	TOT PS S-N
Cargo	3142	3141	2060	2158	1797	1777
Tanker	618	648	222	261	135	129
TugTow	333	319	1206	1053	1631	1696
Service	77	131	49	57	154	133
Passenger	271	104	97	60	1230	1147
Fishing	3451	3447	249	272	428	462
Total	7892 - 100%	7790 - 99%	3883 - 100%	3861 - 99%	5375 - 100%	5344 - 99%

Observe from the last row in Table 10 that contrary to Table 8 the same flow is observed going north bound and south bound at the Georgia Strait crossing line. In contrast for the AIS data in Table 8 85% is travelling southbound. Similarly, one observes that at the WSJF and Puget Sound crossing lines about the same amount of traffic flows in both directions.

Comparing VTOSS 2010 crossing line counts to AIS 2010 crossing line counts.

Observe from Table 9 and Table 4 that the master type category “tanker” includes: chemical carrier, oil tanker, atb and itb. This is consistent with the “tanker” category definition used in the generation of the AIS crossing count data in Table 8. The VTOSS classification “Navy vessel” was given a master type “cargo” classification also for consistency between the VTOSS 2010 master crossing line and AIS 2010 crossing line counts. For the remainder of the 26 vessel types in Table 9, its vessel master type was assigned based on the vessel type classification in Table 9 and Table 4.

In Figure 39, Figure 40 and Figure 41 a comparison is provided between the VTOSS 2010 informed VTRA 2010 model MTS crossing line counts and AIS 2010 crossing line counts in Table 8 and Table 10 for cargo, tanker and passenger vessels. The “tug-tow” master type crossing line counts in Table 10 are not included in the AIS 2010 crossing line counts. The “fishing” VTOSS 2010 master type counts in Table 10 includes the “Fishing vessel” counts from Table 9 that result from fishing vessel tribal and commercial fishing openers that are modeled in the VTRA 2010 MTS simulation model, but are not recorded in the VTOSS 2010 data, nor the AIS 2010 data. Finally, no service vessel classification is provided in the AIS 2010 crossing line counts. Hence, only the comparison provided for the three crossing lines in Figure 38 for the vessel types: cargo, tanker and passenger.

From Figure 39 one observes that the crossing line counts for these three vessel types agree between the two datasets AIS 2010 and VTOSS 2010 both in the east and west bound directions. Overall, one observes a general agreement for the cargo and tanker vessel types in Figure 40 and Figure 41, except for the cargo category travelling northbound in the Georgia Strait where a higher number of crossing counts are reported for the AIS 2010 data. Certainly, some discrepancies are observed for the passenger vessel classification for both the Georgia Strait and Puget Sound crossing lines. We attribute those discrepancies to vessel type misclassification in the VTOSS 2010 dataset. For example, at times the same oil tanker is both classified as a cargo vessel and as a tanker across the three different VTS systems recorded in the VTOSS 2010 dataset. Similar misclassifications are observed for the passenger vessel category. Overall, however, especially when concentrating on the cargo and tanker classifications, there is more agreement between the AIS 2010 and VTOSS 2010 crossing line counts in Figure 39, Figure 40 and Figure 41 than there is disagreement, leading to the conclusion that these two dataset reconcile well. Hence, the

validation of VTOSS 2010 crossing line counts in the GW/VCU MTS simulation model by AIS 2010 crossing line counts.

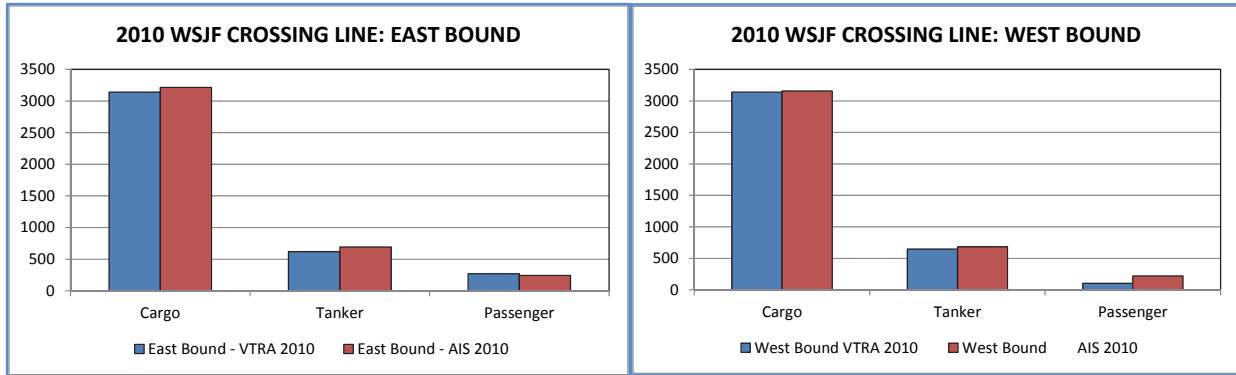

Figure 39. Comparison of AIS 2010 and VTOSS 2010 crossing line counts for cargo, tanker and passenger vessels for the West Strait of Juan de Fuca crossing line depicted in Figure 38B.

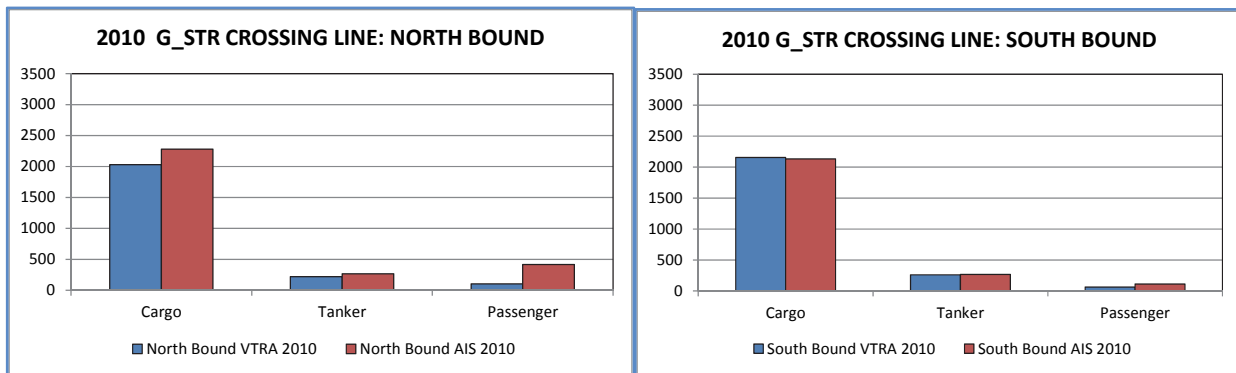

Figure 40. Comparison of AIS 2010 and VTOSS 2010 crossing line counts for cargo, tanker and passenger vessels for the Georgia Strait crossing line depicted in Figure 38C.

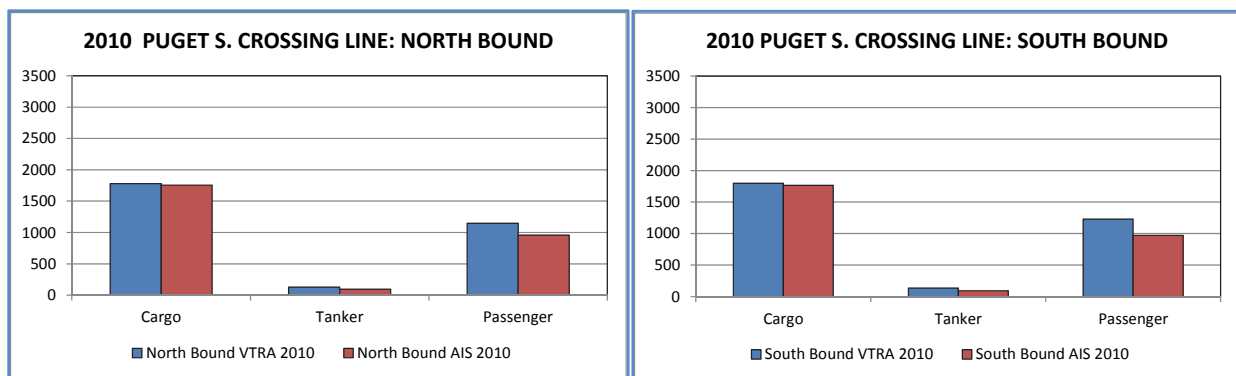

Figure 41. Comparison of AIS 2010 and VTOSS 2010 crossing line counts for cargo, tanker and passenger vessels for the Puget Sound crossing line depicted in Figure 38D.

THIS PAGE IS LEFT
INTENTIONALLY BLANK

5. TRAFFIC PATTERNS AND OIL MOVEMENTS INVTRA 2010 BASE CASE

Running a simulated year 2010 using the methods discussed in Sections 2 and 3, we obtain a comprehensive picture of vessel traffic in the study area. We classify vessel traffic in the VTRA 2010 as focus vessel traffic and non-focus vessel traffic. For focus vessel traffic potential accident frequencies and oil losses shall be evaluated in the remainder of this report. Focus vessel traffic consists of the vessel types: Oil Tankers, ATB's, Chemical Carriers, Bulk Carriers, Container Vessels and a class Other Cargo, capturing other larger cargo vessels. The non-focus vessel traffic is an important modeling aspect of the VTRA 2010 model to evaluate focus vessel collision risk since focus vessels can potentially collide with non-focus vessels⁹. In fact, 75.2% of the total traffic modeled in the 2010 VTRA model is non-focus vessel traffic; the remainder 24.8% is focus vessel traffic. Figure 42 summarizes the focus vessel classification of vessel types in the VTRA 2010 model.

#	VESSEL TYPE	FOCUS VESSEL?	#	VESSEL TYPE	FOCUS VESSEL?
1	BULKCARRIER	CARGO - FV	14	PASSENGERSHIP	NO
2	CHEMICALCARRIER	TANK - FV	15	REFRIGERATEDCARGO	CARGO-FV
3	CONTAINERSHIP	CARGO - FV	16	RESEARCHSHIP	NO
4	DECKSHIPCARGO	CARGO - FV	17	ROROCARGOSHIP	CARGO-FV
5	FERRY	NO	18	ROROCARGOCONTSHIP	CARGO-FV
6	FERRYNONLOCAL	NO	19	SUPPLYOFFSHORE	NO
7	FISHINGFACTORY	NO	20	TUGTOWBARGE	NO
8	FISHINGVESSEL	NO	21	UNKNOWN	NO
9	LIQGASCARRIER	TANK - FV	22	USCOASTGUARD	NO
10	NAVYVESSEL	NO	23	VEHICLECARRIER	CARGO-FV
11	OILTANKER	TANK - FV	24	YACHT	NO
12	OTHERSPECIALCARGO	CARGO - FV	25	ATB	TANK - FV
13	OTHERSPECIFICSERV	NO	26	OIL BARGE	TANK - FV

Figure 42. Focus Vessel Classification of VTRA 2010 vessel types.

Figure 43 and Figure 44 displays 2D and 3D geographic profiles of non-focus vessel traffic, which predominantly consists of fishing vessels (41.3%), Tug-barge traffic¹⁰ (22.9%) and ferry traffic (18.1%). The remaining 17.7% comprises of yachts, navy vessels, passenger ships and service vessels. In the sections to come, we shall provide separate geographic profile analyses for the focus-vessel class (24.8% of total traffic) of which its traffic density is depicted in 2D and 3D geographic profiles in Figure 45 and Figure 46, respectively.

⁹ Of course focus vessels can also potentially collide with other focus vessels.

¹⁰ This 17.2% does not include oil barge traffic which is considered a focus vessel class

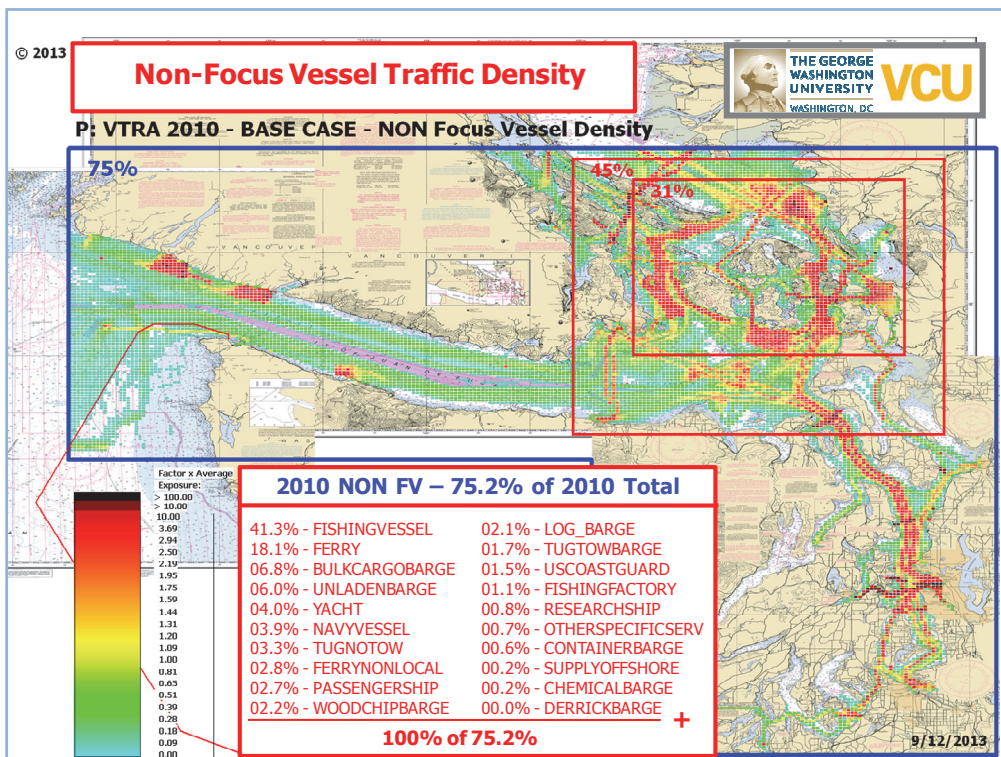

Figure 43. 2D depiction of the traffic density for all non-focus vessels.

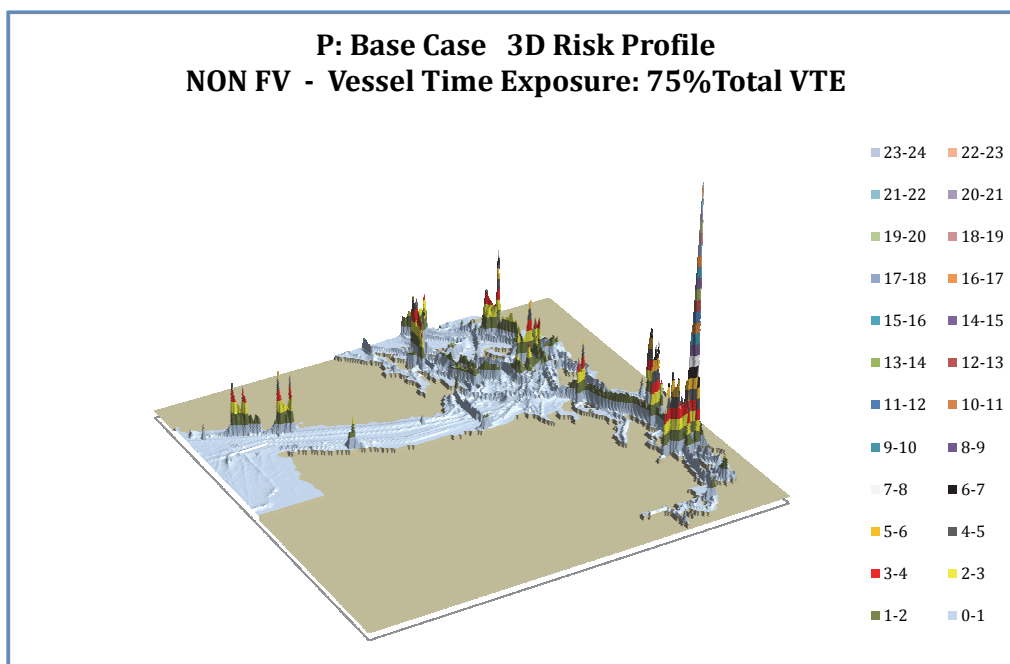

Figure 44. 3D depiction of the traffic density for all non-focus vessels.

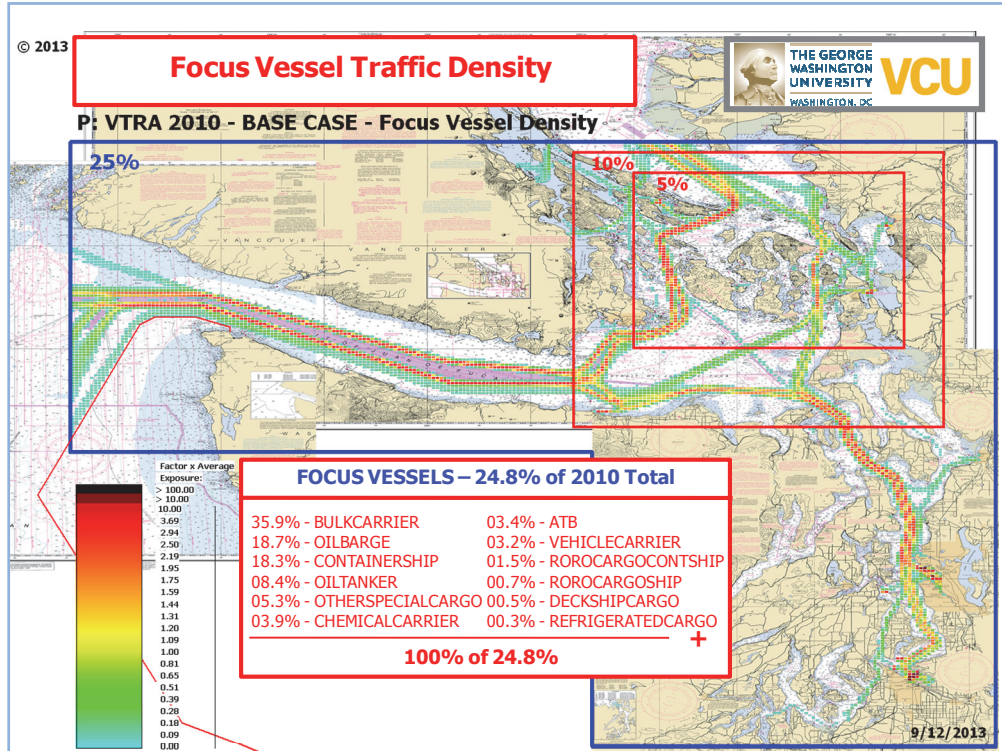

Figure 45. 2D depiction of the traffic density for all focus vessels.

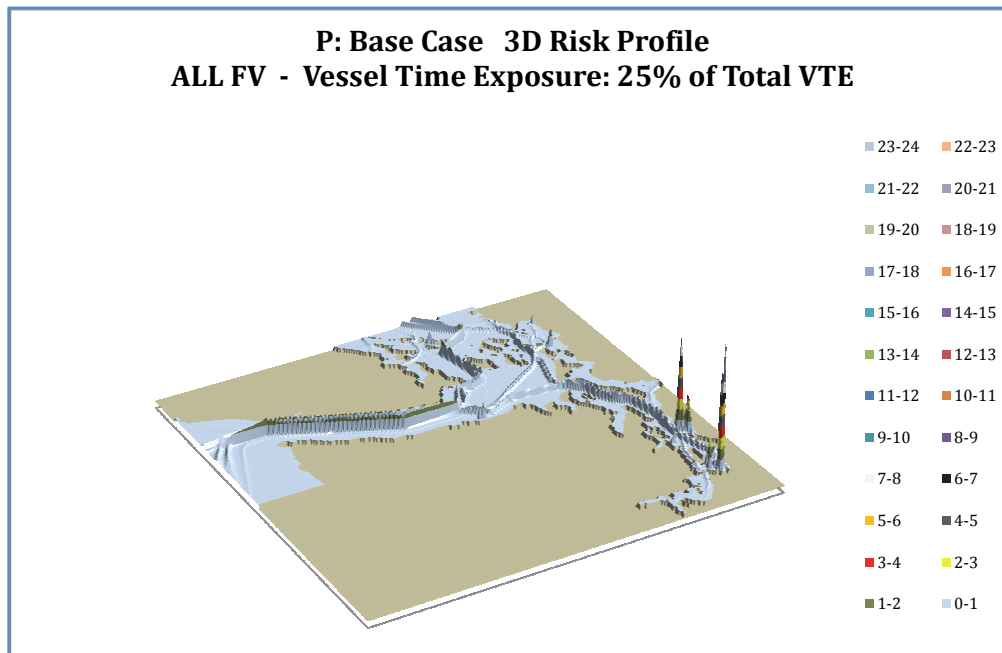

Figure 46. 3D depiction of the traffic density for all focus vessels.

FINAL REPORT: VTRA 2010

In sections to come, traffic movements representing time of focus vessels on the water are summarized in terms of cargo focus vessel (bulk carrier, container and other cargo) density profiles and tank focus vessel (oil barge, oil tanker, chemical carrier and atb) density profiles. The oil (crude, product and fuel) that cargo and tank focus vessels transport are summarized in oil movement density geographic profiles. For contrast purposes focus-vessel density profiles shall be presented using their own color legend rather than the color legend used in Figure 43 and Figure 45.

Vessel Time of Exposure (VTE)

Let us first examine the time each type of focus vessel spends in the system; 65.7% of the focus vessel total time of exposure is attributed to cargo focus vessels, with the remaining 34.3% being tank focus vessels. Of the cargo focus vessel's total time of exposure, 54.6% is bulk cargo, 27.8% is container vessels, and 17.6% is other cargo vessels. Of the tank focus vessel's total time of exposure, 54.5% is oil barges, 24.4% tankers, 11.1% chemical carriers, and 9.8% articulated tug barges. To find the contribution of oil barges, for example, to the focus vessel total time of exposure, we consider that 34.3% of the focus vessel total is tank focus vessels and 54.5% of the tank focus vessel total time of exposure is oil barges, so 34.3% multiplied by 54.5% gives 18.7% of the focus vessel total time of exposure. Figure 47 shows the contribution of each focus vessel type to the total focus vessel time of exposure calculated in this manner.

Oil Time of Exposure (OTE)

Thus far, we have examined the focus vessel time of exposure, where we count the amount of time that vessels move through study area by grid cell. Rather than focusing on vessels it is also instructive to examine the amount of time a unit of oil (measured in either barrels or cubic meters) is moving through the study area. This includes cargo (product and crude) oil and fuel oil that focus vessels transport; so all focus vessels contribute to the total oil time of exposure; 39.4% of the total oil time of exposure is product, 36.9% is crude, and 23.7% is fuel. Figure 48 shows the total oil time of exposure broken down by vessel type. Tankers comprise almost half of the total oil time exposure at 48.1%. Oil barges comprise about a fifth at 20.6%. However, the vessel type with the next largest contribution is container vessels, which carry only fuel oil, at 8.9% and not chemical carriers. This is of course a result of the fact that more container vessels travel through the VTRA study area than chemical carriers. In fact, overall fuel oil from cargo focus vessels comprises 19.7% of the total oil time exposure.

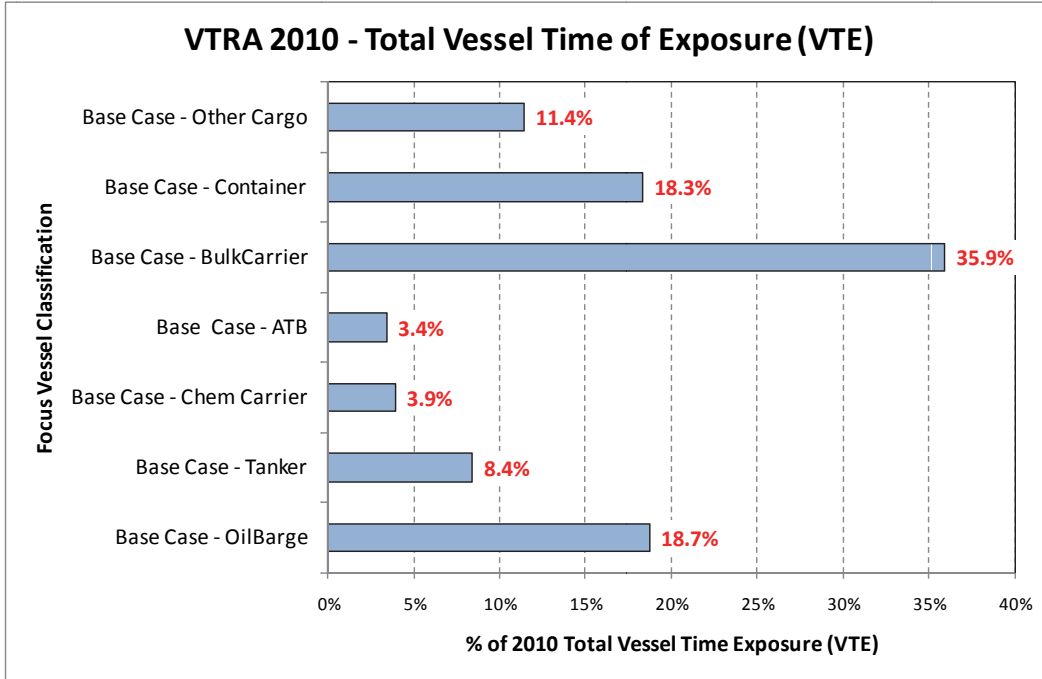

Figure 47. Comparison of the total vessel time of exposure by focus vessel classification

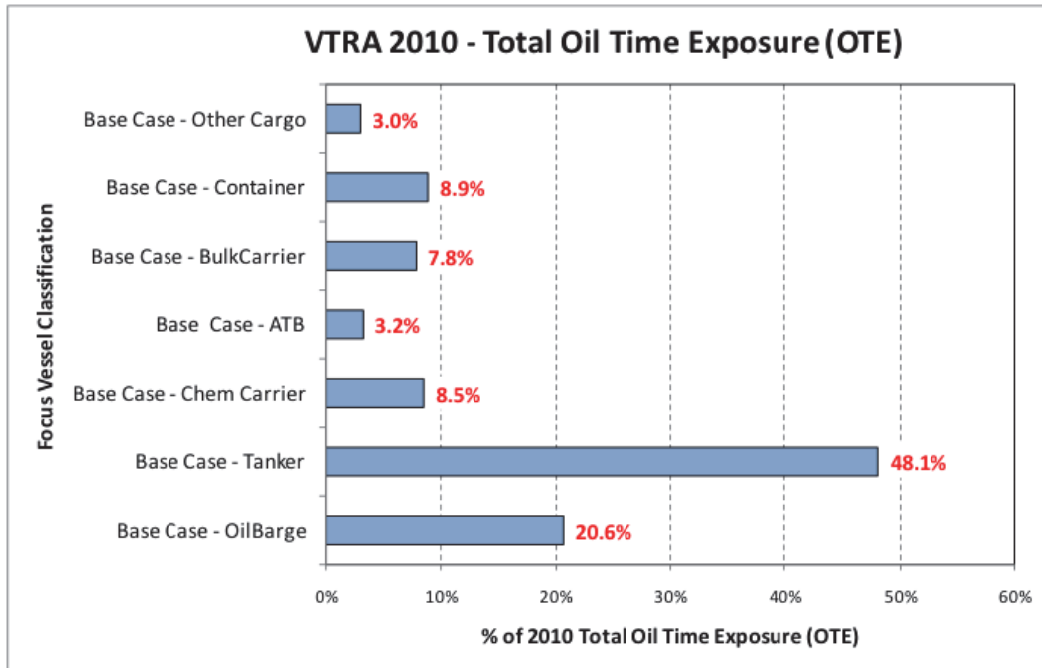

Figure 48. Comparison of the total oil time of exposure by focus vessel classification

Traffic Densities Profiles

Figure 47 shows that bulk carriers spend the most time transiting the study area at 32.5% of the total, followed by container vessels at 20.2%, and oil barges at 19.3%. Oil tankers comprise 8.8% of the total. While these aggregate statistics are useful, we are also interested in where these vessels spend time in the VTRA study area. Figure 49 and Figure 50 show the cargo focus vessel and tank focus vessel traffic densities respectively. The left panels of Figure 49 and Figure 50 show the 2D geographic profile format, whereas the right panels depict a 3D geographic profile. The 2D and 3D graphical profiles complement one another. While a 2D geographic profile provides more detailed information, the relative distribution of traffic density is more easily discerned from the 3D geographic profile format.

Comparing Figure 49 and Figure 50 is quite instructive. Apparently, cargo focus vessels transit the Straits of Juan de Fuca and then Haro Strait, Boundary Pass, and Georgia Strait going north and the Puget Sound going south. Meanwhile, the traffic density for tank focus vessels is most significant in Rosario Strait and Puget Sound (and near the pilot station in Port Angeles). Thus, cargo and tank focus vessels mostly transit different areas of the system, except for the Puget Sound where they converge.

Oil Movement Density

Again it is instructive to view the geographic spread of the oil movement exposure, called the oil movement density. Figure 52, Figure 53, Figure 54 shows the oil movement densities for product, crude, and fuel oil respectively. The left panels show the 2D geographic profile format, whereas the right panel depicts the 3D geographic profiles. Product oil (39% of oil movement) moves throughout the system as depicted in Figure 52¹¹. Figure 53 shows that crude oil (37% of oil movement) moves predominantly from Buoy J to the Cherry Point, Ferndale, and Anacortes refineries with the largest spike observed at the Cherry Point refinery in the right panel of Figure 53. Figure 54 shows that fuel oil (24% of oil movement) moves predominantly in the areas where cargo focus vessels transit in Figure 49. Figure 51 combines the information depicted in Figure 52, Figure 53 and Figure 54 and shows the total oil movement density. Thus, Figure 51 shows that oil moves on all major traffic lanes in the study area. The highest oil movement density areas are on the approaches to refineries and near the pilot station. We now know that the largest spike in the right panel of Figure 51 at the Anacortes refineries results both from product and crude oil, whereas the other two spikes at the Ferndale and Cherry Point refineries predominately arise from crude oil.

¹¹ The spike in Figure 52 is located at the Anacortes refineries.

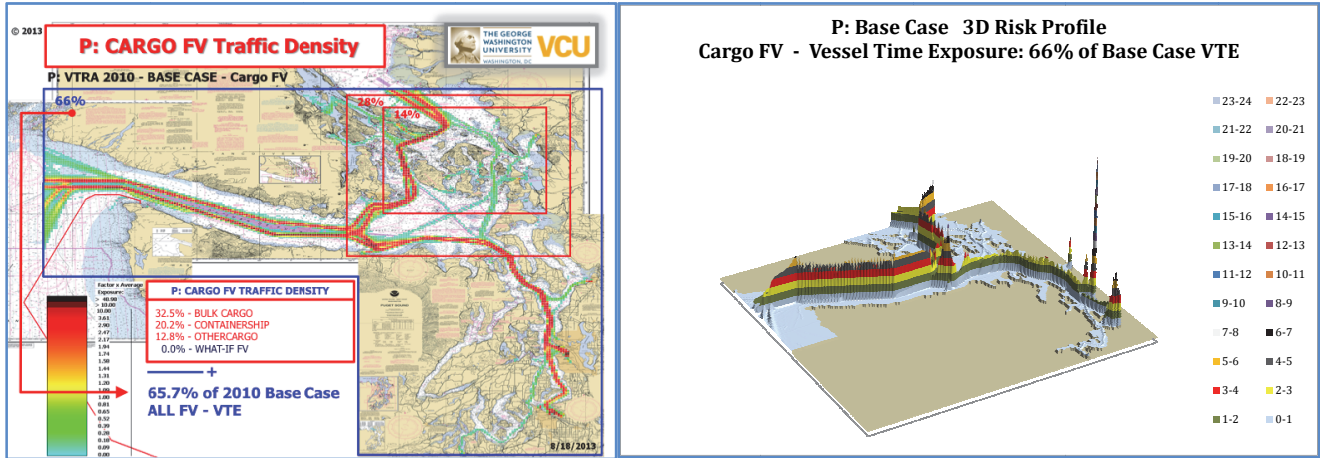

Figure 49. The traffic density for cargo focus vessels.

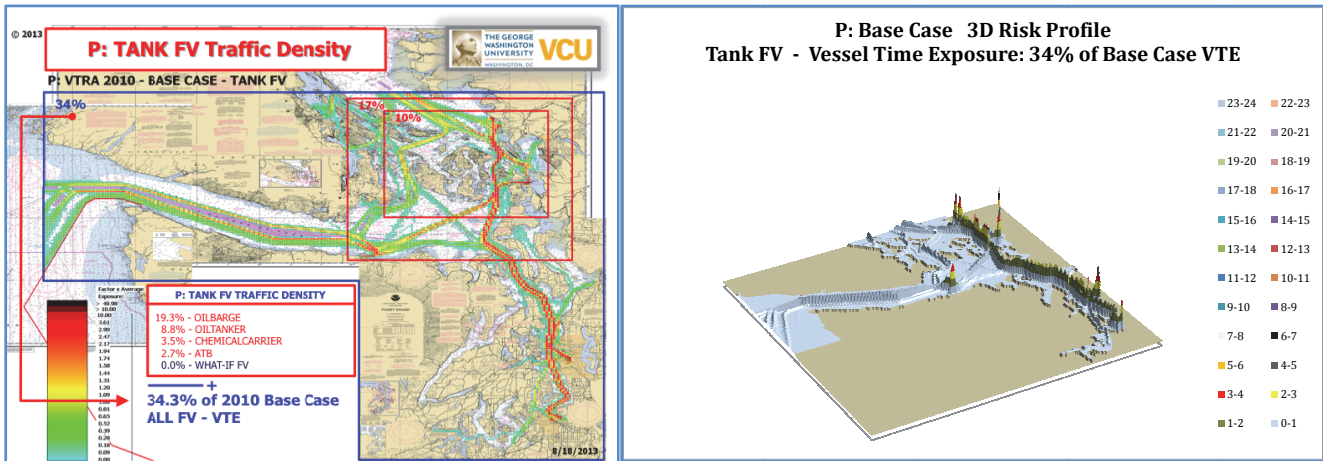

Figure 50. The traffic density for tank focus vessels.

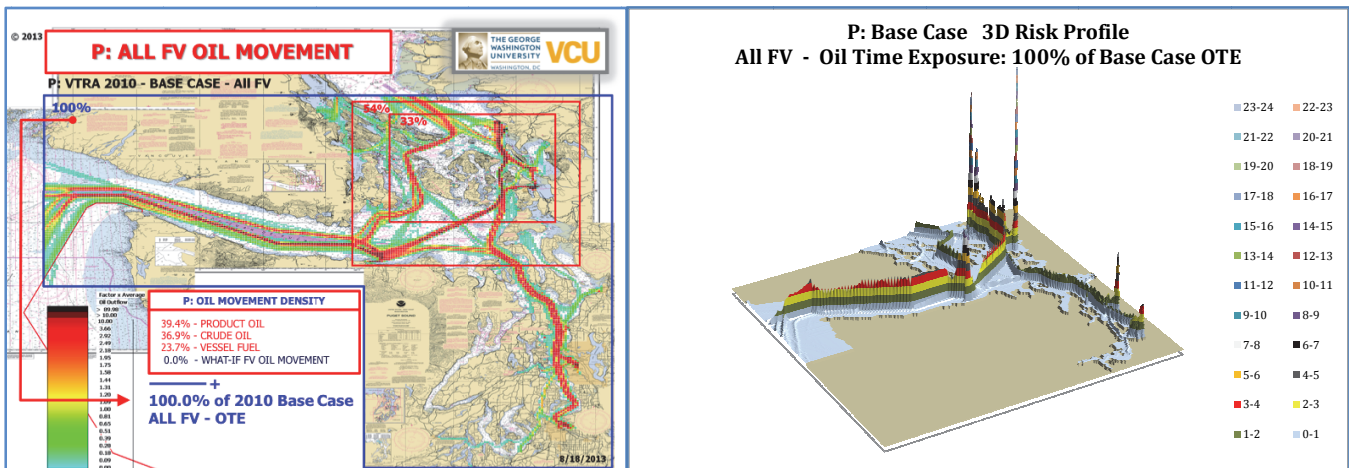

Figure 51. The total oil movement density for all focus vessel

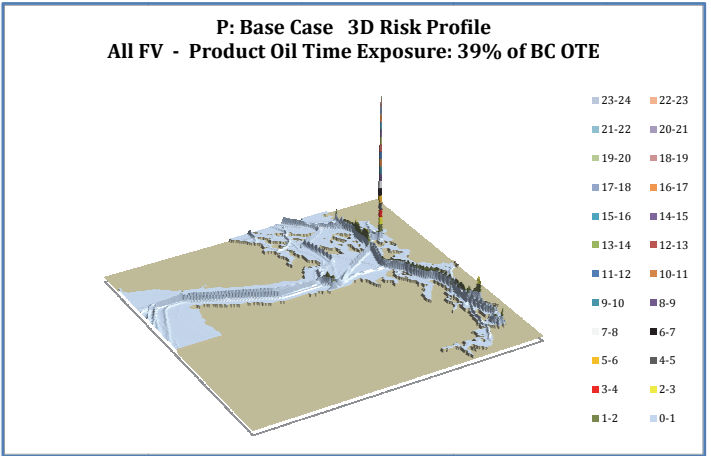
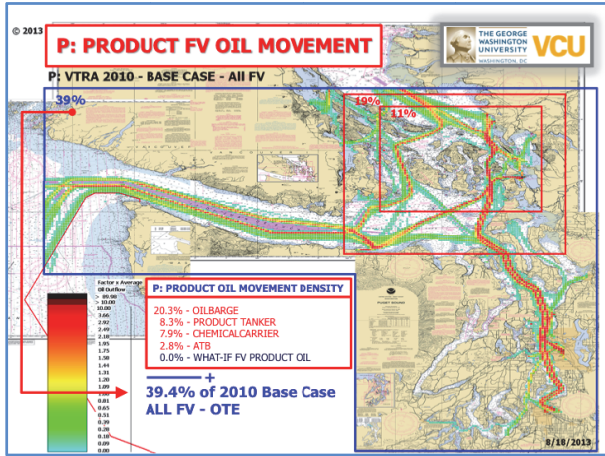

Figure 52. The product oil movement density for all focus vessels.

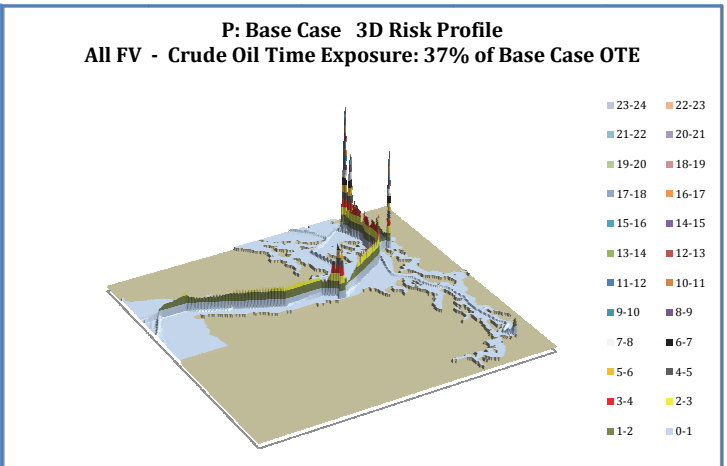
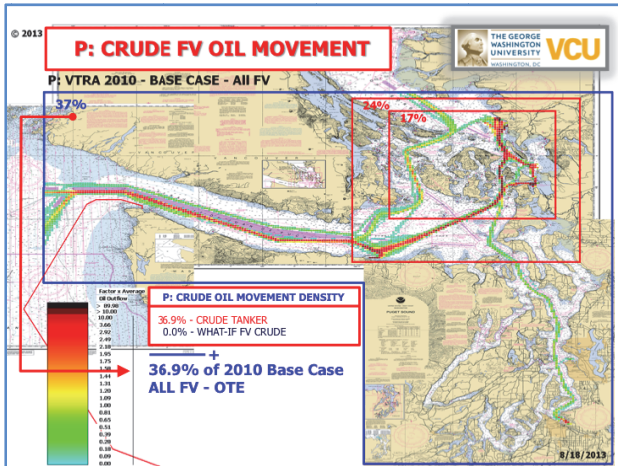

Figure 53. The crude oil movement density for all focus vessels.

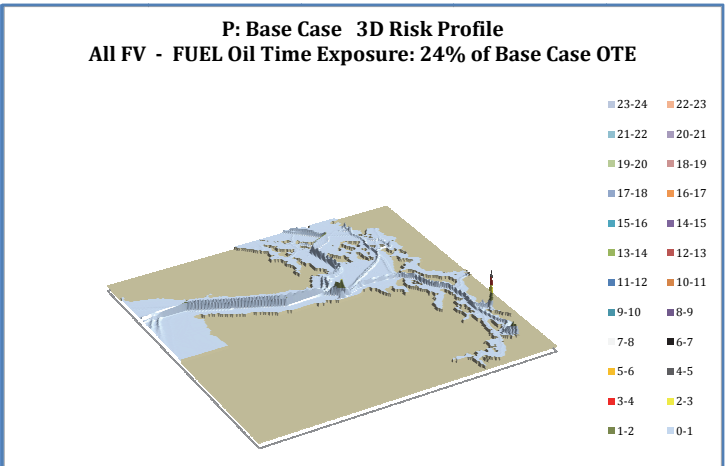
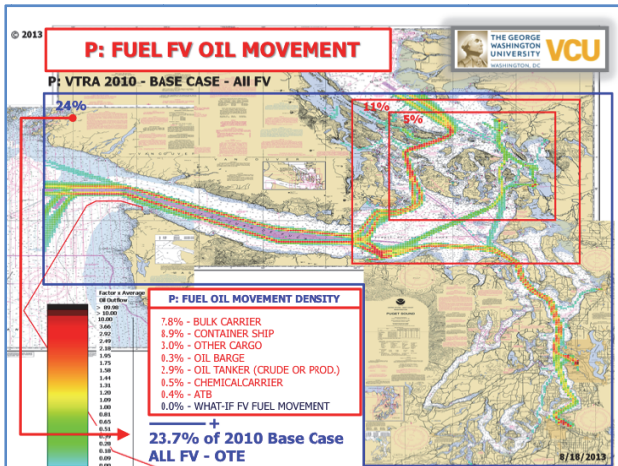

Figure 54. The fuel oil movement density for all focus vessels.

6. ACCIDENT FREQUENCY AND OIL OUTFLOW RESULTS FOR VTRA 2010 BASE CASE

Figure 3 shows the accident causal chain, with the situations in which an accident can occur, the incident that causes the accident, the accident itself, and the consequences of the accident. We call the situations in which an accident could occur an accident exposure. For each accident exposure, the incident and accident probability models are used to calculate the POTENTIAL accident frequency. This is not a prediction of an accident, but shows a relative propensity that an accident could occur in one accident exposure versus another or the relative propensity for one type of accident versus another. The accident exposure and the POTENTIAL accident frequency are then combined with the oil outflow model to calculate the POTENTIAL oil outflow.

Overall Accident and Oil Outflow Results

Figure 55 shows the accident exposure (A), the POTENTIAL accident frequency (B), the POTENTIAL accident cargo oil loss (C), and the POTENTIAL accident fuel oil loss (D) for each accident type. Figure 55A shows that more power grounding accident exposures are counted in the 2010 simulation than other accident types, with drift grounding accident exposures next as the vessel drifts ashore after losing power, and collision accident exposures next as two vessels must interact to be counted. Allisions have the lowest exposure as they only occur as the vessel is near to its intended dock.

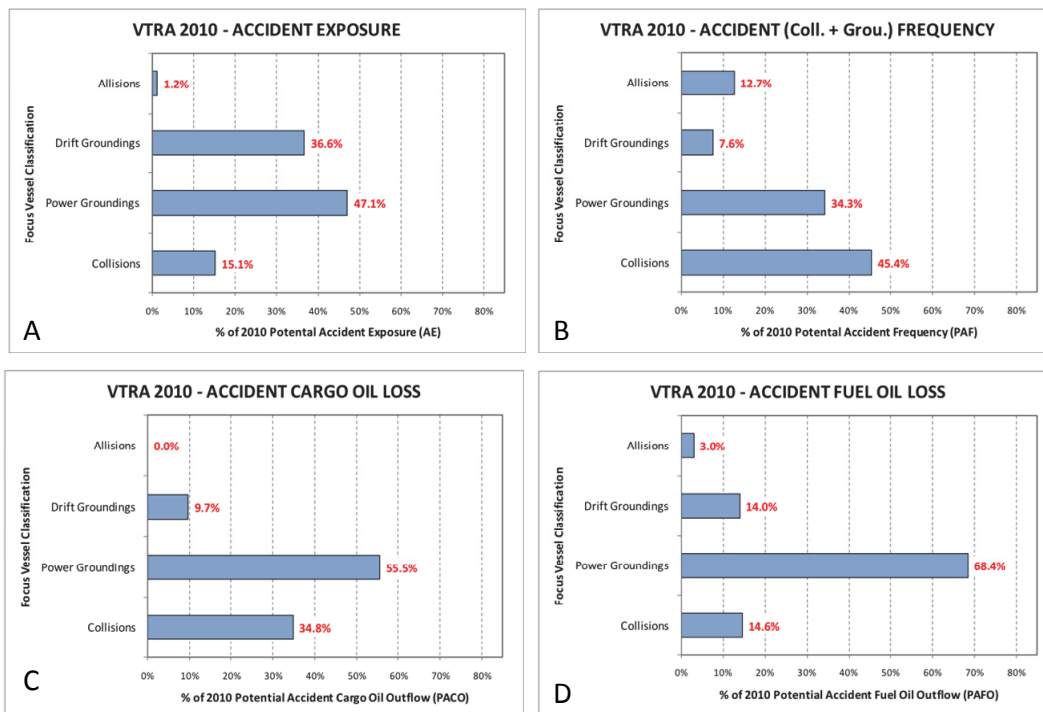

Figure 55. Accident exposure (A), accident frequency (B), cargo oil loss (C), and fuel oil loss (D).

FINAL REPORT: VTRA 2010

All exposures do not have the same potential for an accident, however. Figure 55B shows that collisions have a higher POTENTIAL accident frequency than either grounding types even though the collision accident exposure is lower. The accident probability varies from accident exposure to accident exposure based on the specifics of the situation in which it occurs, but on average the collision exposures have a higher potential to result in an accident than the grounding exposures. Powered groundings have the next highest potential. In fact, collisions and powered groundings together comprise 79.7% of the POTENTIAL accident frequency.

Similarly, not all accidents have the same POTENTIAL for oil outflow. While collisions have higher POTENTIAL accident frequency, powered groundings have the highest POTENTIAL accident cargo oil loss (Figure 55C) and the highest POTENTIAL accident fuel oil loss (Figure 55D).

Accident and Oil Outflow Results by Focus Vessel Type

Figure 56 breaks down the POTENTIAL accident frequencies by the type of focus vessels that has the initiating incident. This is the first figure to have a POTENTIAL accidents-per-year scale. However, this is again not a prediction of a number of accidents each year, but a relative propensity for each accident type involving each focus vessel type. The highest potential is for collisions involving oil barges, with as much collision POTENTIAL as tankers, chemical carriers, and cargo vessels combined. Powered grounding POTENTIAL is more spread across oil barges and cargo vessels.

Figure 57 breaks down the POTENTIAL oil loss by the type of focus vessels that has the initiating incident. This figure has a POTENTIAL average cubic-meters-per-year scale. Again this is not a prediction of an amount of oil outflow each year, but a relative propensity for oil outflow for each accident type involving each focus vessel type. Clearly, tankers have the highest POTENTIAL as they carry the highest volume of cargo. However, container vessel powered groundings have the next most contribution as they carry larger amounts of fuel oil and tend to travel relatively at higher speeds. Oil barges do not have the same contribution to POTENTIAL oil loss as they do to POTENTIAL accident frequency. We believe this to be a result of the combined effect of (1) oil barges traveling at relative low speeds, (2) oil barges having assigned double hull protection in the VTRA 2010 models and finally, (3) oil barges not carrying as much cargo or fuel oil.

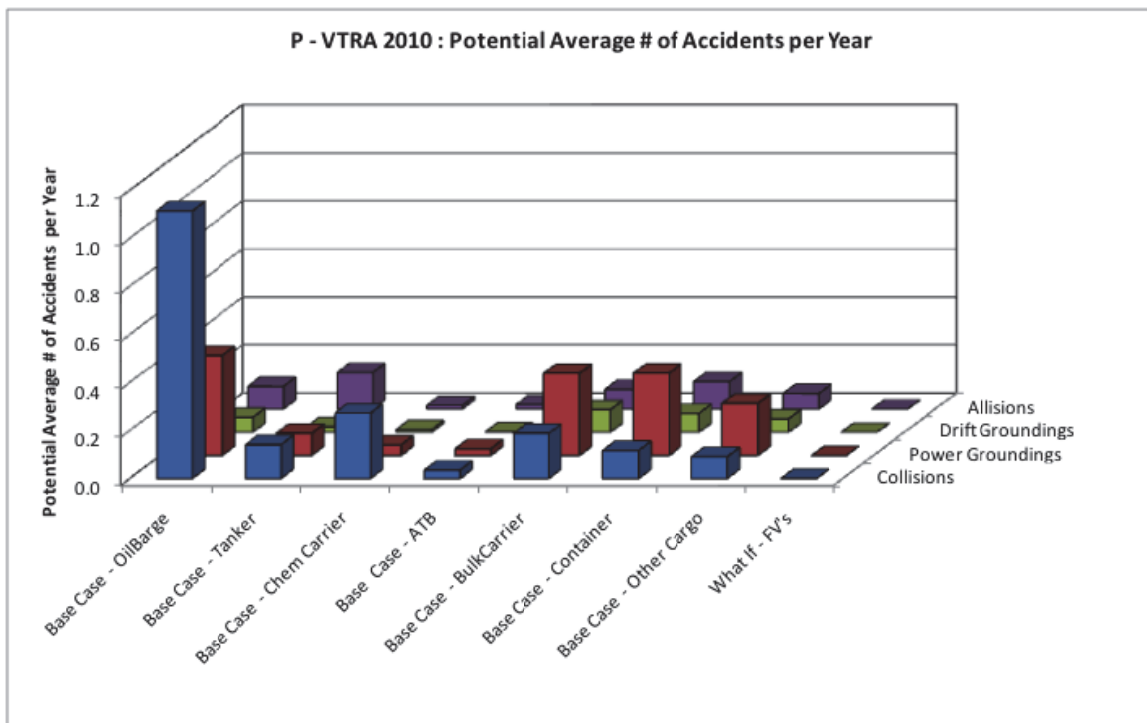

Figure 56. The POTENTIAL accident frequency by accident type and focus vessel type.

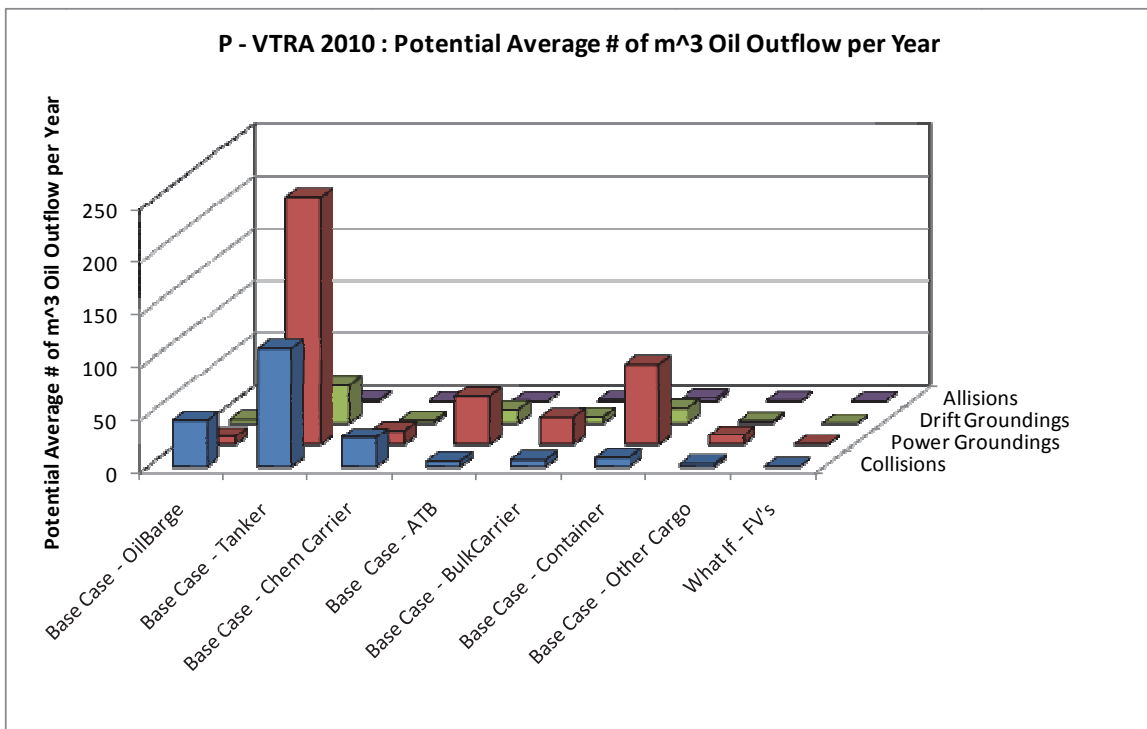

Figure 57. The POTENTIAL oil loss by accident type and focus vessel type.

Geographic Profiles of Accident and Oil Outflow Results

Figure 58 through Figure 63 show the same progression of accident exposure, POTENTIAL accident frequency, and POTENTIAL oil loss, but as geographic profiles. Figure 58, Figure 59 and Figure 60 show the geographic profiles of collision exposure, POTENTIAL collision frequency, and POTENTIAL collision oil loss respectively. Figure 61, Figure 62 and Figure 63 show the geographic profiles of grounding exposure, POTENTIAL grounding frequency, and POTENTIAL grounding oil loss respectively.

These figures demonstrate the importance of thinking about all phases of the accident event chain depicted in Figure 3. Figure 58 shows that there is exposure to collisions in the Straits of Juan de Fuca, while Figure 59 shows that exposure does not lead to as much POTENTIAL collision frequency as other areas with exposure. In fact, the POTENTIAL collision frequency appears more prevalent in Haro Strait/Boundary Pass, Rosario Strait, and the Puget Sound. Comparing these figures to Figure 60, we can see that while the area around the Pilot Station does not have a relatively high POTENTIAL collision frequency it does have a concentration of POTENTIAL collision oil loss due to the size and type of the vessels involved. Rosario Strait, Guemes Channel, and Haro Strait all have concentrations of POTENTIAL collision oil loss. In fact, the inner red box contains 67% of the POTENTIAL collision frequency and 53% of the POTENTIAL collision oil loss. Similarly, the outer red box contains 83% of the POTENTIAL collision frequency and 70% of the POTENTIAL collision oil loss. In Rosario Strait and Guemes Channel, the vessels involved are oil tankers (with larger oil cargos) and ferries and other vessels that are large enough to potentially penetrate the hull, but are not restricted by the one-way zone.

A similar effect is seen in Figure 61 through Figure 63. Again there is exposure to grounding along the shore of the Straits of Juan de Fuca, but there is not much POTENTIAL grounding frequency as the time to shore is relatively long in this area. The relatively more significant POTENTIAL grounding frequency and POTENTIAL grounding oil loss are in the red boxes. The inner red box contains 41% of the POTENTIAL grounding frequency and 61% of the POTENTIAL grounding oil loss. Similarly, the outer red box contains 58% of the POTENTIAL grounding frequency and 79% of the POTENTIAL grounding oil loss.

Combining POTENTIAL collision frequency profiles (Figure 59) and POTENTIAL grounding frequency profiles (Figure 62) results in the geographic POTENTIAL accident frequency profiles depicted in Figure 64. Combining POTENTIAL collision oil loss profiles (Figure 59) and POTENTIAL grounding loss profiles (Figure 62) results in the geographic POTENTIAL accident loss profiles depicted in Figure 64.

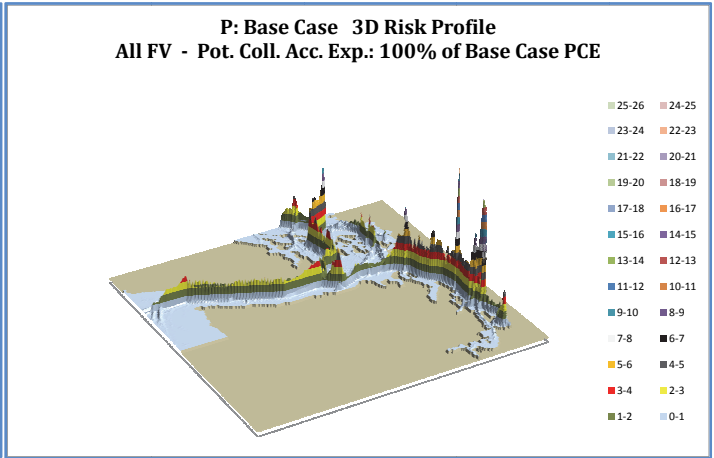
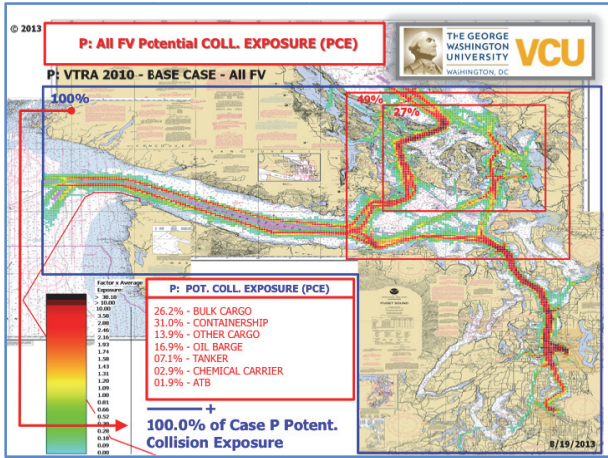

Figure 58. The geographic profile of the collision exposure.

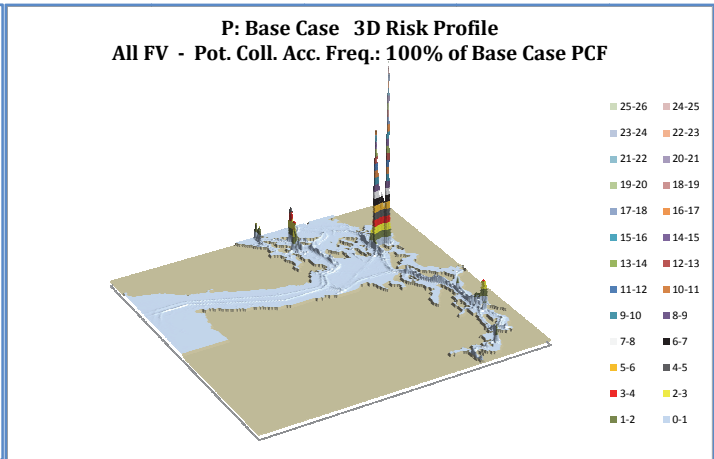
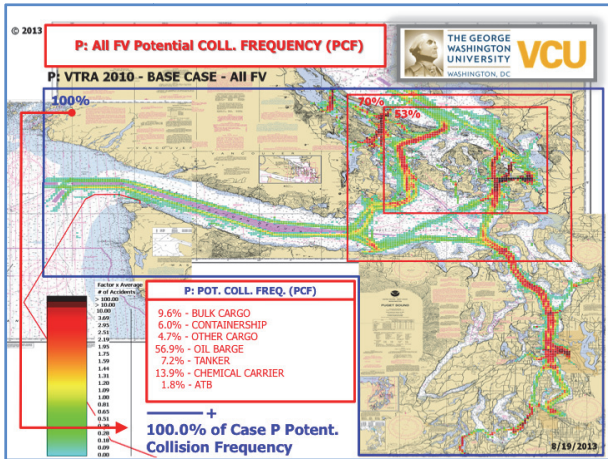

Figure 59. The geographic profile of the POTENTIAL collision frequency.

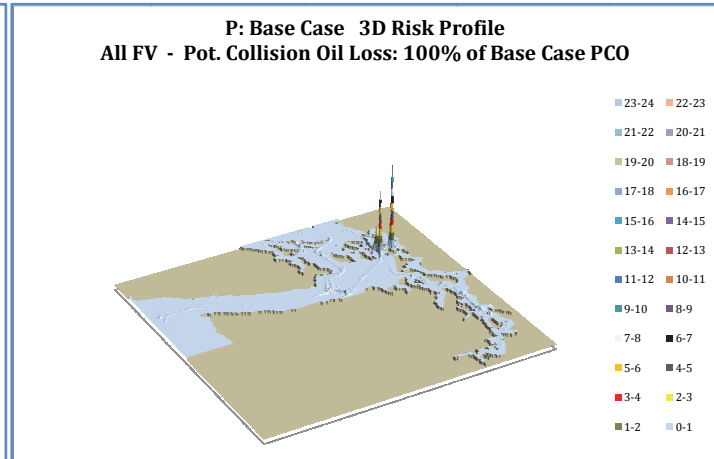
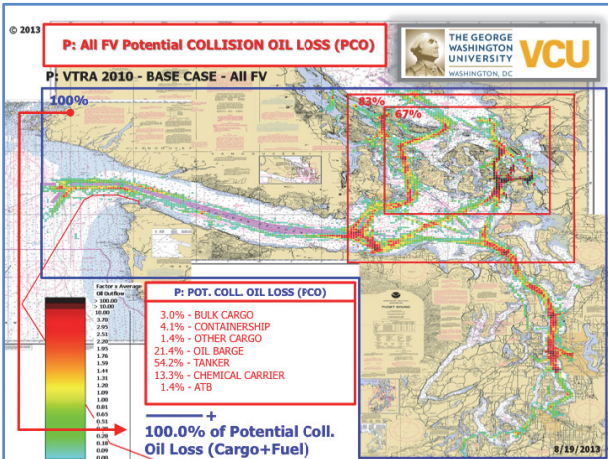

Figure 60. The geographic profile of the POTENTIAL collision oil outflow.

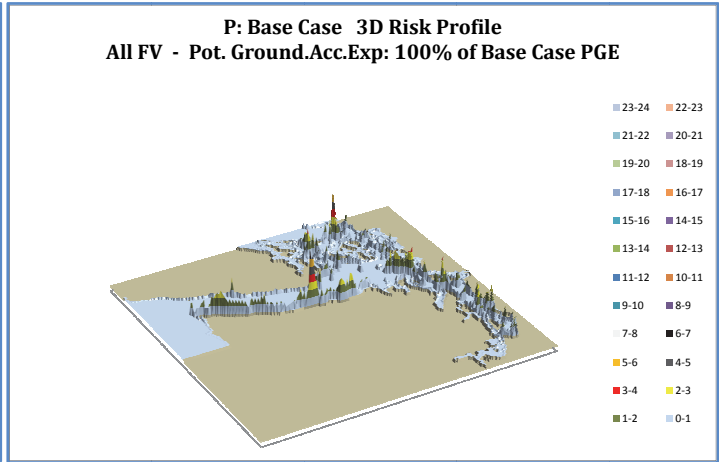
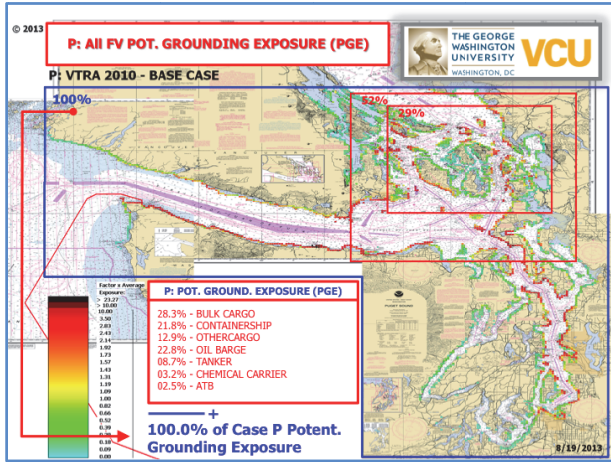

Figure 61. The geographic profile of the grounding exposure.

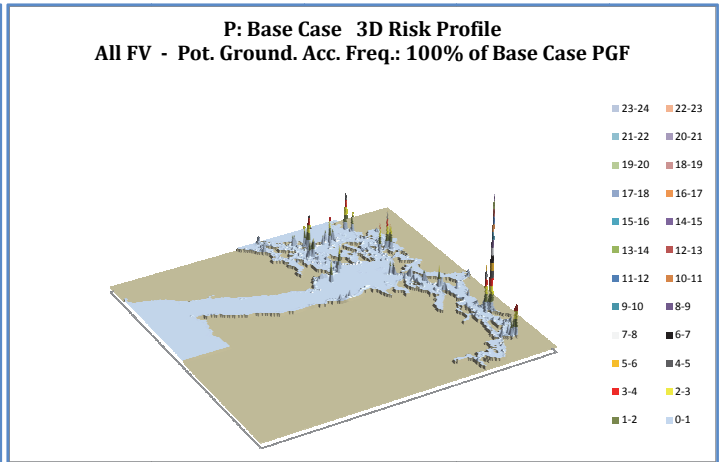
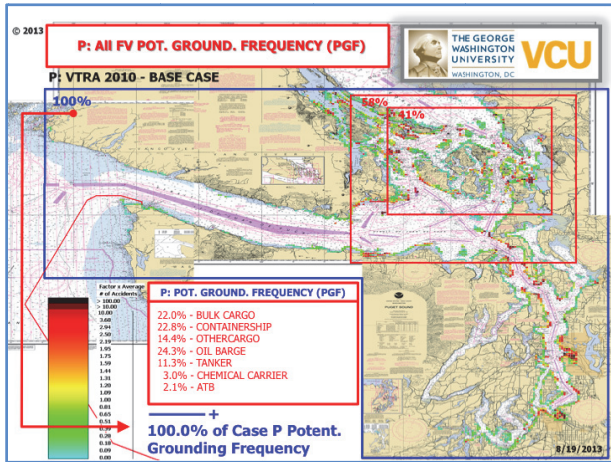

Figure 62. The geographic profile of the POTENTIAL grounding frequency.

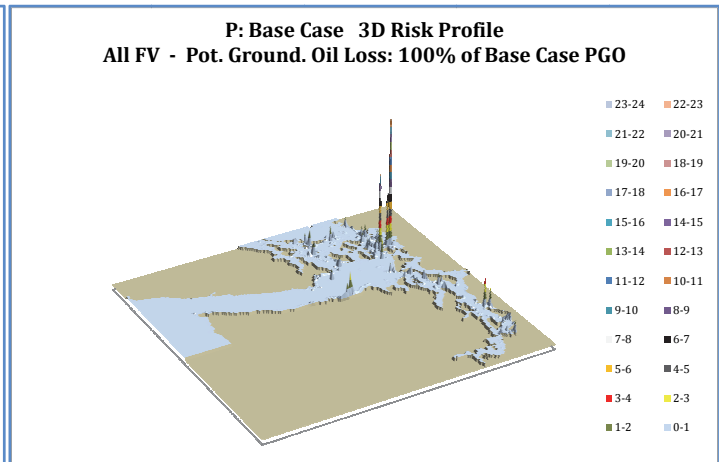
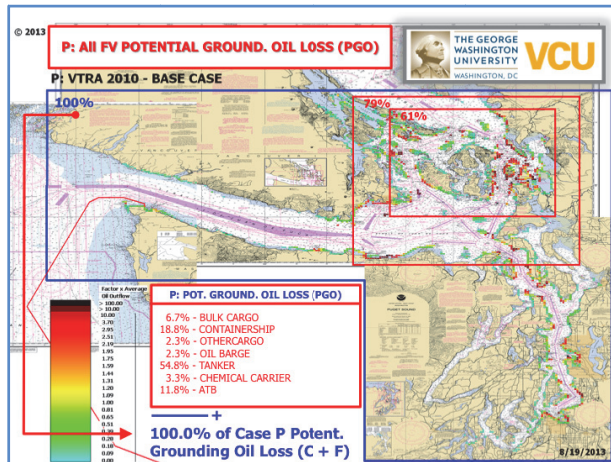

Figure 63. The geographic profile of the POTENTIAL grounding oil outflow.

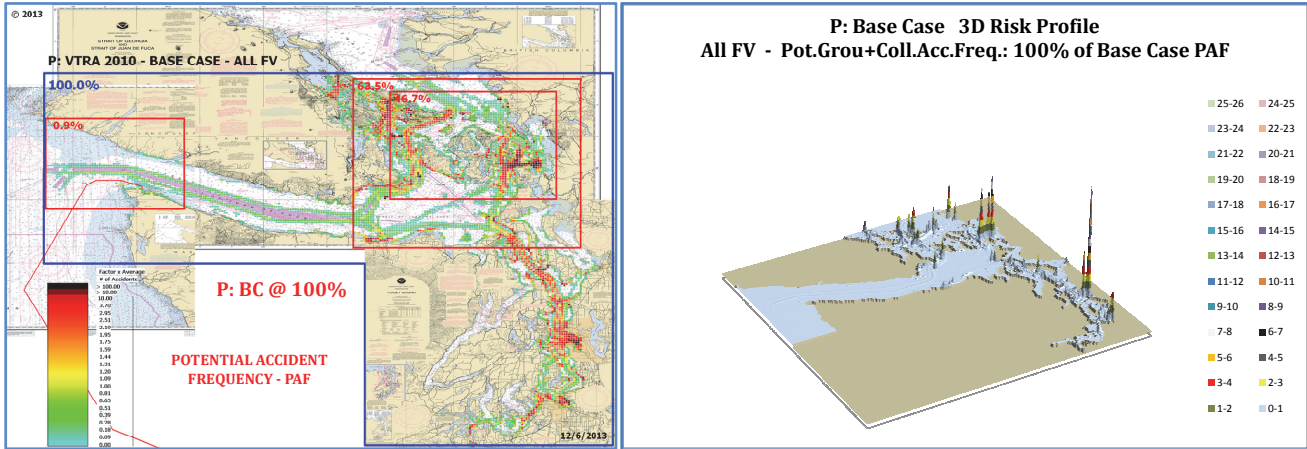

Figure 64. The geographic profile of POTENTIAL accident (collision + grounding) frequency.

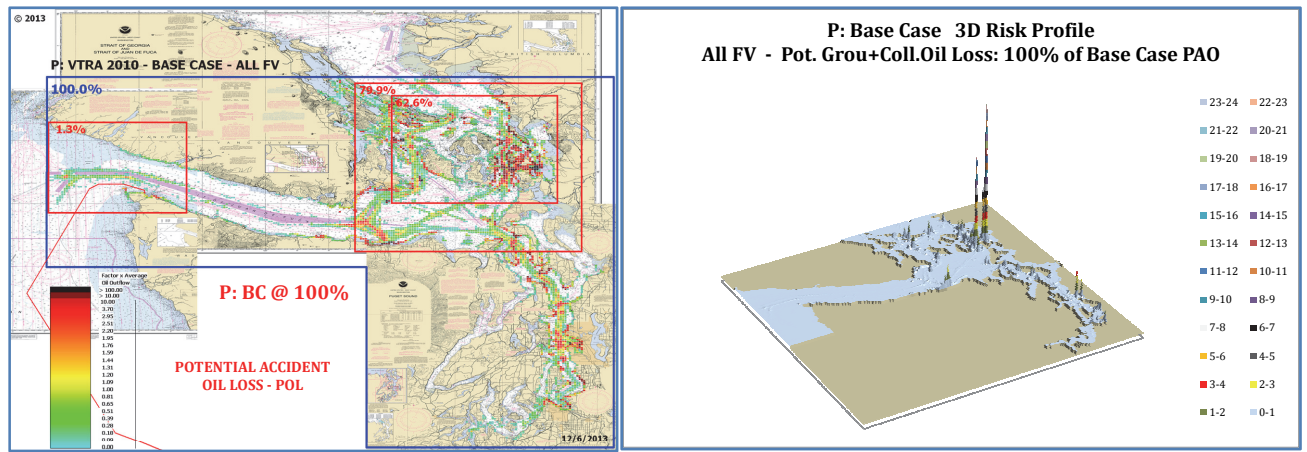

Figure 65. The geographic profile of POTENTIAL accident (collision + grounding) oil outflow.

In sections to come we shall provide geographic profile analysis results for combined POTENTIAL accident frequencies and POTENTIAL oil loss results as presented for the 2010 base case year in Figure 64 and Figure 65 for the various What-If and RMM Scenarios. When presenting these geographic profiles the panels in Figure 64 and Figure 65 shall be repeated for visual contrast purposes. Detailed and broken-down analysis results by collisions and groundings are available in the format of result presentations at:

http://www.seas.gwu.edu/~dorpjr/tab4/publications_VTRA_Update.html

THIS PAGE IS LEFT
INTENTIONALLY BLANK

7. WHAT-IF SCENARIOS

This study does not attempt to predict the future of vessel traffic in the study area. Such predictions are often made based on observable trends in the traffic levels or projections of potential economic changes and their possible impacts on traffic levels. As we have seen in the last decade, predicting global economic changes is difficult and unpredictable. Economic changes can lead to unforeseen changes in traffic levels and reversals in previously observed trends. This means predictions can prove to be inaccurate, particularly in the medium to long term.

Modeling the What-If Scenarios

In this study, the Steering Committee chose to model only the traffic level impacts of planned expansion and construction projects that were in advanced stages of a permitting process. Each planned project forms a What-If scenario and What-If vessels are added to the simulation of the 2010 Base Case year. Four What-If scenarios were modeled in the study (see Table 11).

Table 11. Descriptors and short descriptions of Base Case and four What-If Scenarios

WHAT IF SCENARIO ANALYSIS	
P - Base Case	Modeled Base Case 2010 year informed by VTOSS 2010 data amongst other sources.
Q - GW - 487	Gateway expansion scenario with 487 additional bulk carriers and bunkering support
R - KM - 348	Transmountain pipeline expansion with additional 348 tankers and bunkering support
S - DP - 415	Delta Port Expansion with additional 348 bulk carriers and 67 container vessels
T - GW - KM - DP	Combined expansion scenario of above three expansion scenarios

The next step in modeling the What-If scenarios is to determine the routes that the additional vessels will take in the simulation. Routes were chosen from the VTOSS 2010 data for vessels that actually transited the system to each location. The only change to an actual route that was made was for the Gateway routes as the bulk terminal is not yet in operation, so routes that went close to the planned terminal were chosen and modified to the correct location. Figure 66, Figure 67, and Figure 68 show the What-If vessel routes for the Gateway case, the Trans-Mountain Pipeline Expansion case, and the Delta Port case respectively.

Adding this number of additional vessels will also lead to additional bunkering operations in the study area. The Steering Committee determined that 47% of Gateway vessels would bunker on the inbound transit and as a first analysis the bunkering would take place at the Vendovi anchorage. The bunkering tug would transit from Seattle to Vendovi anchorage laden and then return to Seattle.

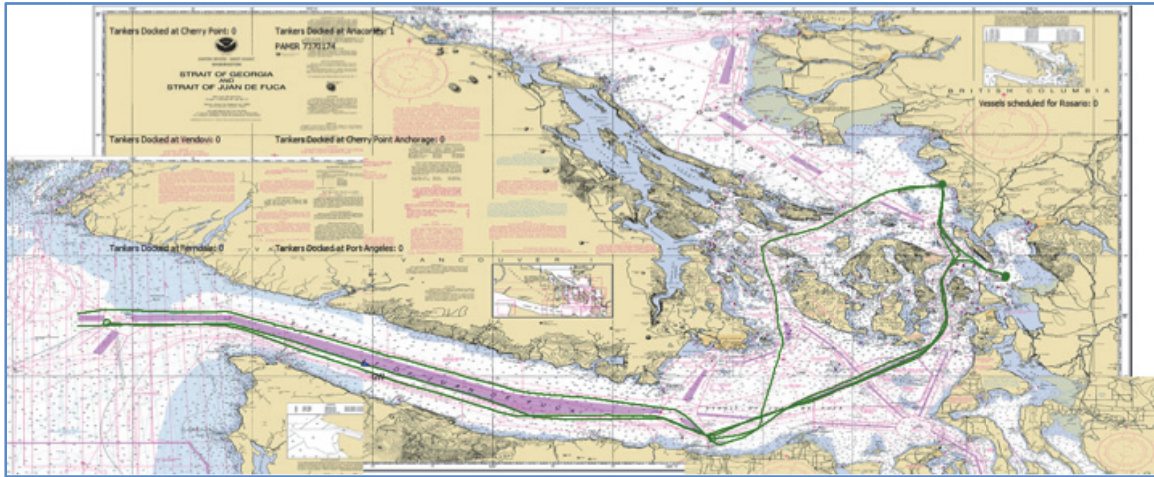

Figure 66. The routes used for the What-If vessels in the Gateway case.

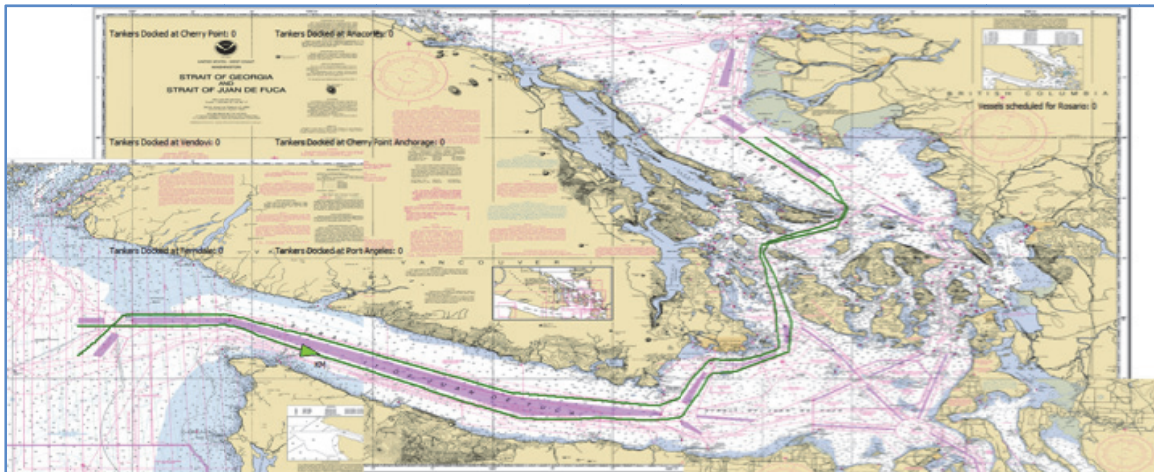

Figure 67. The routes used for the What-If vessels in the Trans-Mountain Pipeline Expansion case.

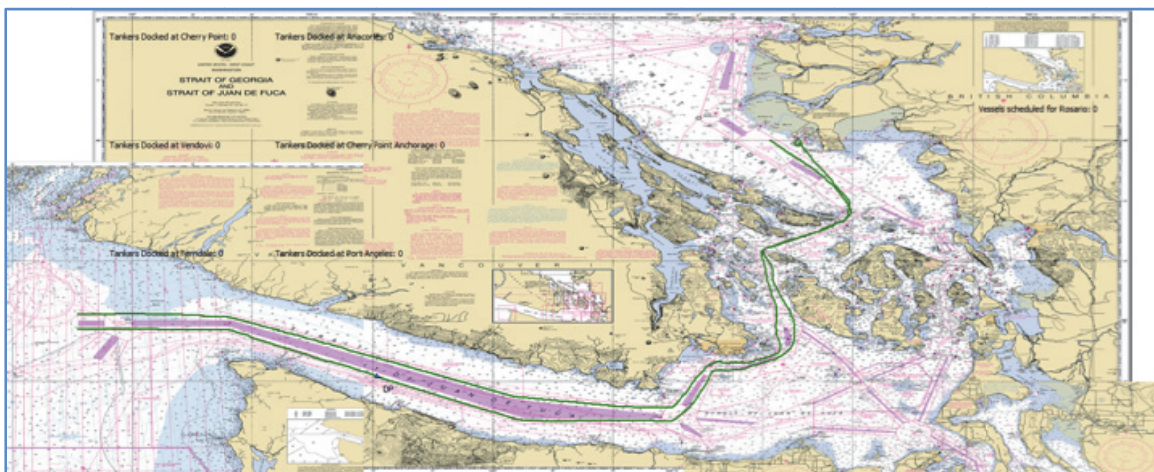

Figure 68. The routes used for the What-If vessels in the Delta Port case.

The Steering Committee decided that bunkering for the Trans-Mountain pipeline expansion scenario and the combination of proposed changes at Delta Port would take place out of the study area, but would require additional bunkering supply transits, 34 for the Delta Port bulk carriers, 6 for the Delta Port container vessels, and 21 for the Trans-Mountain pipeline expansion oil tankers annually. As a first analysis, these bunkering supply transits are modeled as transiting from the Cherry Point area and out of the study area to the north. Figure 69 shows the bunkering tug routes used for the what-if scenarios.

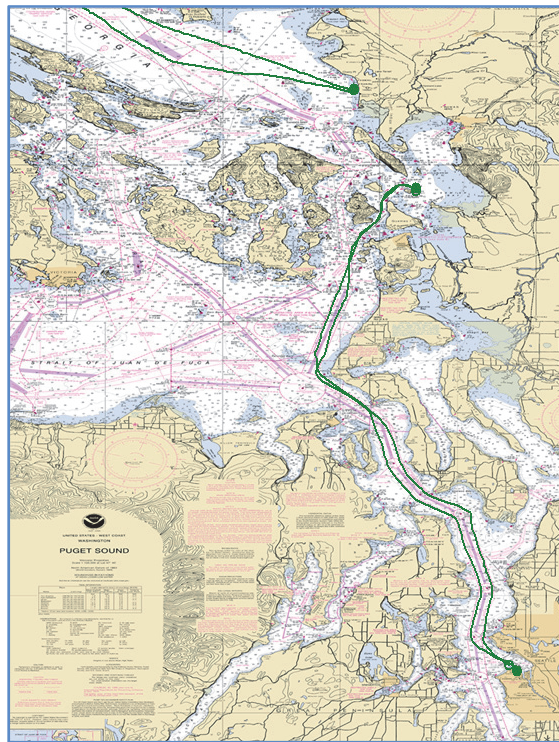

Figure 69. The tug routes used for additional bunkering in the What-If scenarios.

The final decision concerning modeling What-If scenarios relates to the arrival patterns of the additional vessels. While knowing the count of the number of vessels of each type calling at a given dock or port is informative, to simulate the vessels over time one must know the time between one such vessel arriving in the system and the next. The variability in these inter-arrival times changes from destination to destination and from vessel type to vessel type. The variability in inter-arrival times for each of the projects in the What-If scenarios will not be known until the projects have been underway for a period of time. In modeling, if the specifics of a situation are unknown and there is no data upon which to base modeling decisions, the simplest assumption is preferable. In this case, the simplest assumption is to assume that the inter-arrival times are all equal and that the vessels arrive at a constant rate. This assumption can be changed in later analysis, but it is a reasonable approach to start modeling the What-If scenarios.

Summary of System-Wide What-If Scenarios Results

Adding What-If vessels to the 2010 Base Case can have multiple effects, both direct and indirect effects:

1. What-If vessels directly increase the vessel exposure time and the oil exposure time. This means the What-If vessel will add to the collision and grounding exposure. With additional exposure the What-If vessels can have a triggering incident and so add to the POTENTIAL collision and grounding frequencies.
2. While a What-If vessel interacts with another vessel, the other vessel also may have a triggering incident and so there is another source of increase in the POTENTIAL collision and grounding frequencies. This source of increase is attributed to the vessel having the triggering incident, but would not be there without adding the What-If vessel to the simulation. This can still be considered a direct effect.
3. When the What-If vessel passes through the one-way zone at Rosario Strait and the exclusion zone at Boundary Pass, this can cause delays or slow down other vessels that are part of the original 2010 Base Case. This changes the 2010 Base Case vessel's transit through the system and can either increase or decrease their exposure and hence collision and grounding POTENTIAL. As an example, Figure 70 shows two screenshots that occurred within a simulated hour of one another in a What-If simulation. The figure shows one northbound (left) and one southbound (right) tanker interacting with a fleet of fishing vessels returning to port at the end of the day. If the tankers transits had occurred two hours earlier (as occurred in the Base Case 2010 simulation) then the interactions would not have occurred. These interactions occurred because of a change in the timing of tankers and led to an increased exposure and so an increased POTENTIAL for collision that is not caused directly by a What-If vessel and thus ought to be considered an indirect effect.

Figure 71 shows three graphs. Each shows the percentage change in a given simulation output metric from the 2010 Base Case results. The change is shown for each What-If scenario and for completeness the 2010 Base Case is shown as a 0% change from itself. The change is shown as a bar graph, but the actual percentage change is also shown in text. The left panel graph in Figure 71 shows the change in vessel time exposure, the middle graph shows the change in POTENTIAL collision frequency, and the right panel graph shows the change in POTENTIAL grounding frequency. One can observe in Figure 71 that the changes in both POTENTIAL collision frequency and POTENTIAL grounding frequency are driven by the changes in exposure time. The changes in POTENTIAL collision frequency are larger than the changes in POTENTIAL grounding frequency.

Figure 72 shows a similar set of graphs as Figure 73, but this time showing the changes in fuel oil time exposure in the left panel graph, POTENTIAL collision fuel oil loss in the middle graph, and POTENTIAL grounding fuel oil loss in the right panel graph. The exposure changes for fuel oil are not exactly the same as vessel time exposure changes in value (as different vessel types carry

different amounts of fuel), the overall pattern across the What-If scenarios, however, is the same and the ensuing changes in POTENTIAL collision and grounding fuel loss display a similar pattern.

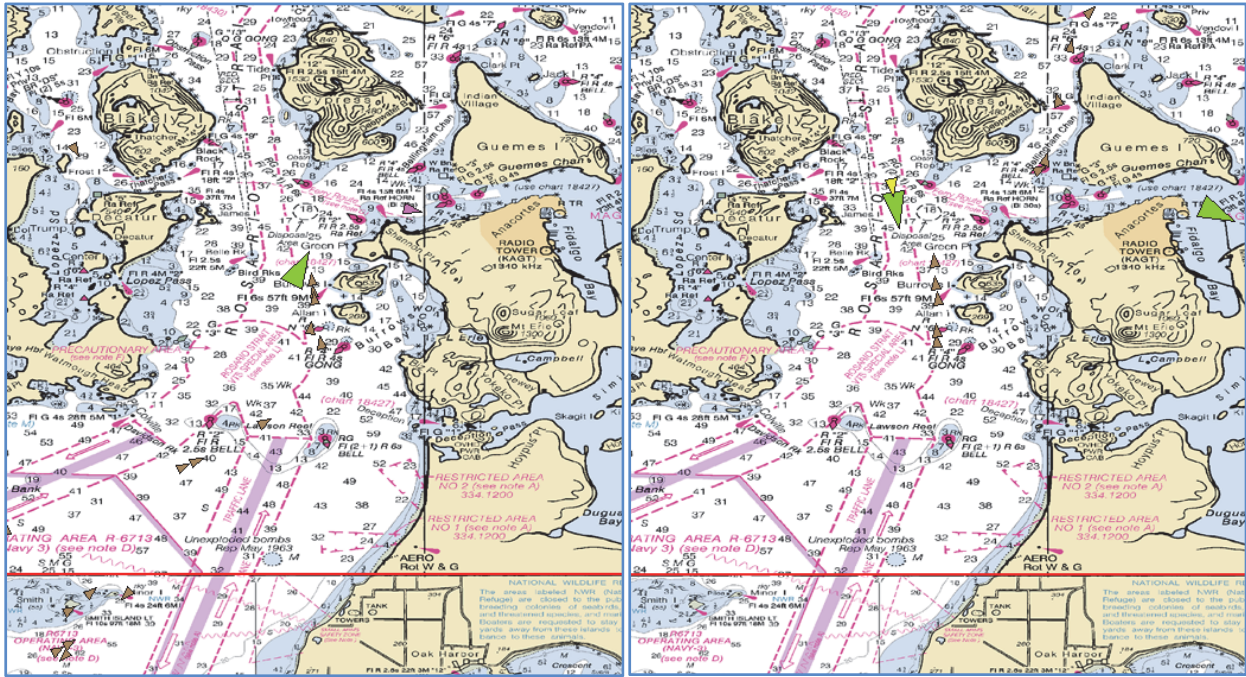

Figure 70. An indirect effect of a What-If scenario - the change in timing of the tanker transits causes two tankers (green triangles) to interact with a fishing fleet (gray triangles) returning to port at the day's end.

Figure 73 shows a similar set of graphs as Figure 71 and Figure 72, but this time showing the changes in cargo oil time exposure in the left panel graph, POTENTIAL collision cargo oil loss in the middle graph, and POTENTIAL grounding cargo oil loss in the right graph. The patterns in exposure changes shown in Figure 73 are not the same as in Figure 71 and Figure 72 as the bulk carriers and container vessels in Gateway and Delta Port What-If scenarios do not carry cargo oil. Thus, the Trans Mountain Pipeline Expansion project leads to the greatest increases in cargo oil time exposure. This leads to the higher increases in POTENTIAL collision cargo oil loss and POTENTIAL grounding cargo oil loss.

However, there is another interesting result as the change in POTENTIAL collision cargo oil loss for the Gateway scenario is not proportional to the change in cargo oil time exposure. The additional What-If bulk carriers in the Gateway scenario do not carry cargo oil. There is only a modest increase in POTENTIAL collision frequency for the Gateway scenario in Figure 71, so this result must be caused by a change in the mix of vessels interacting with Base Case tank vessels that do carry cargo oil. One would expect that this result is driven by increased interactions between Base Case tank vessels and Gateway bulk carriers. However, the result is not so simple.

FINAL REPORT: VTRA 2010

There is a change in mix of interactions in the Gateway What-If Scenario with multiple types of vessels around the Rosario Strait one-way zone, including other oil tankers, ferries, fishing vessel and barges etc. This is the indirect effect discussed at the beginning of this section where the What-If vessels passing through the one-way zone at Rosario Strait, causes a delay or slowdown of other vessels that are part of the original 2010 Base Case, and leads to a change in the vessel mix interacting with tank focus vessels. This is an interesting result and could not be found without building a detailed simulation model of the system to capture such indirect effects.

Moreover, a worthwhile consideration is whether the changes caused by the combined What-If scenario is just the sum of the changes caused by each of the three separate What-If scenarios or whether there is an interaction between the scenarios being operational simultaneously. The changes in the POTENTIAL collision frequency (Figure 71, green bordered panel) from the three separate What-If scenarios add up to $13\% + 9\% + 10\% = 32\%$. The change from the combined What-If scenario is only 21%. Thus the dynamics of the system here are changed in a way that reduces collision risk. On the other hand (Figure 72, green bordered panel), the POTENTIAL fuel losses of collisions are additive for the three What-If scenarios. However, the changes in the POTENTIAL collision cargo oil loss (Figure 73, green bordered panel) from the three separate What-If scenarios add up to $37\% + 44\% - 2\% = 79\%$. The change for the combined What-If scenario is 97%. Thus the mix of vessels from the three What-If Scenarios involved in interactions with Base Case 2010 vessels must lead to more POTENTIAL oil losses. The most plausible cause for this effect is the combination of containers and bulk carriers using Haro-Strait to transit to Delta Port and the additional tankers using Haro-Strait to transit to Vancouver.

The changes in the POTENTIAL grounding frequency from the three separate What-If scenarios add up to $11\% + 3\% + 3\% = 16\%$. The change from the combined What-If scenario is 17%. These are close, and it would appear that grounding frequency changes are about additive. On the other hand, the changes in the POTENTIAL grounding cargo oil loss from the three separate What-If scenarios add up to $0\% + 50\% + 0\% = 50\%$. The change in POTENTIAL oil loss from the combined What-If scenario is 73%. So again we have an increase beyond the sum of the three individual What-If scenarios, which likely means that the vessels involved in the additional grounding potential are tank vessels.

Finally, Figure 74 combines the results from Figure 71, Figure 72 and Figure 73 and presents the percent changes in vessel time exposure, potential accident frequency and potential accident oil loss from the base case. Again, for completeness the base case is included as 0% as a reference point in Figure 74. Observe from Figure 74 that while the vessel time exposure percentages from the three separate What-If scenarios added equate to the vessel time exposure percentage of the combined case, one observes this is not the case for accident frequencies combined and oil losses combined. Most notably, the combined case has a potential oil loss increase of 68%, whereas the

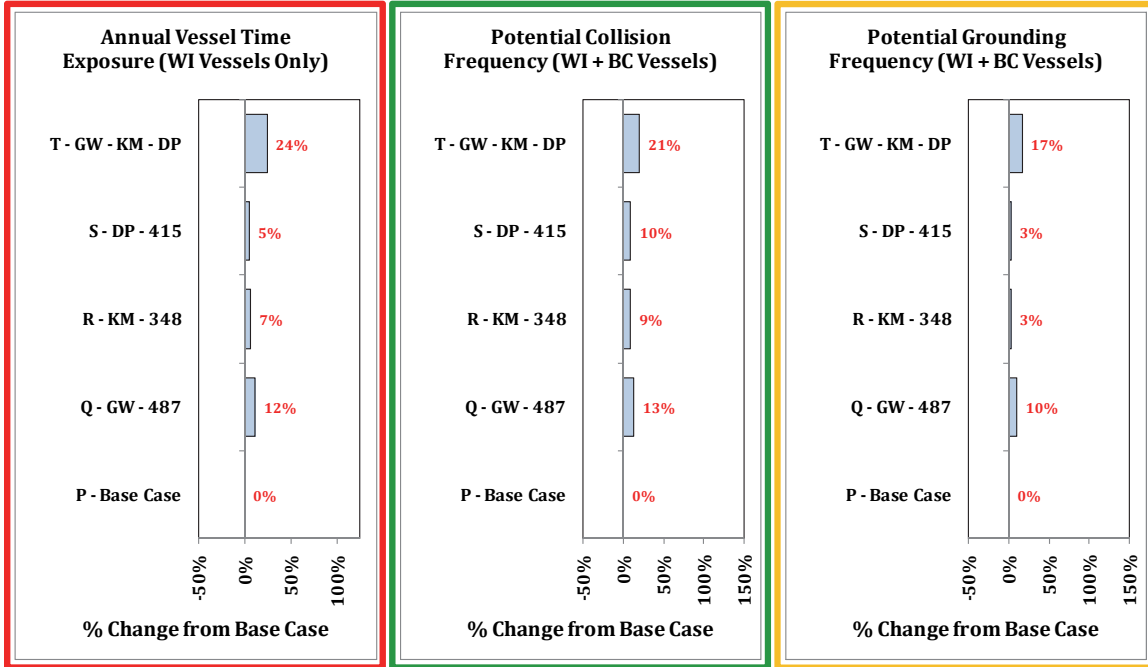

Figure 71. An overview comparison of the changes from the 2010 base case for each What-If scenario in terms of vessel time of exposure, POTENTIAL collision frequency, and POTENTIAL grounding frequency.

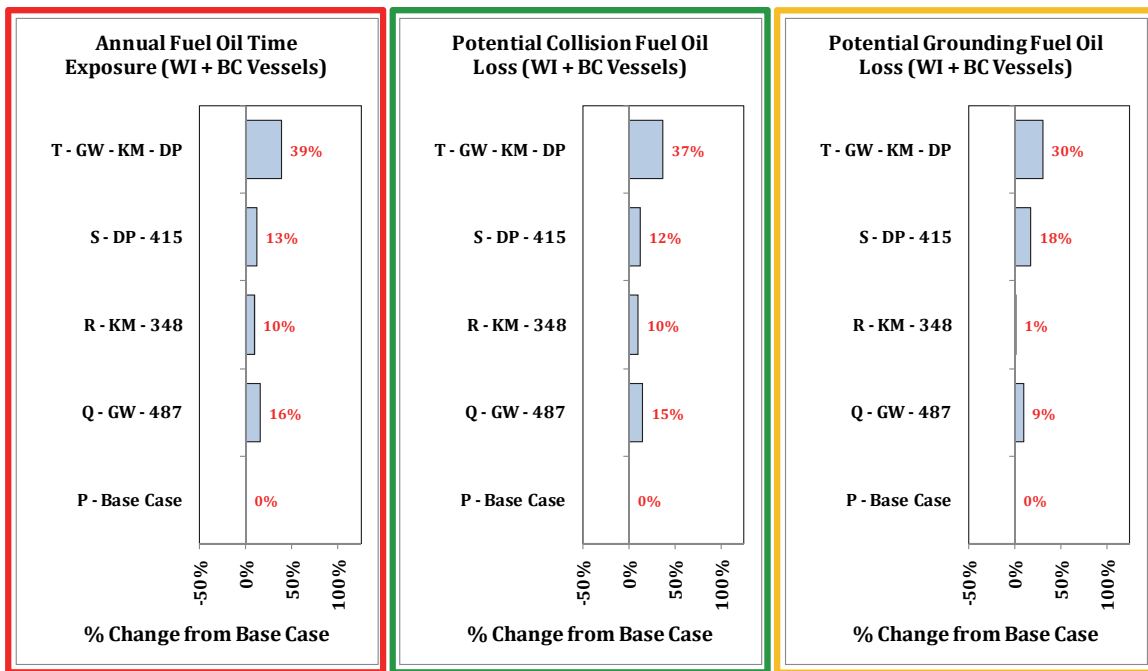

Figure 72. An overview comparison of the changes from the 2010 base case for each What-If scenario in terms of fuel oil movement exposure, POTENTIAL collision fuel oil loss, and POTENTIAL grounding fuel oil loss.

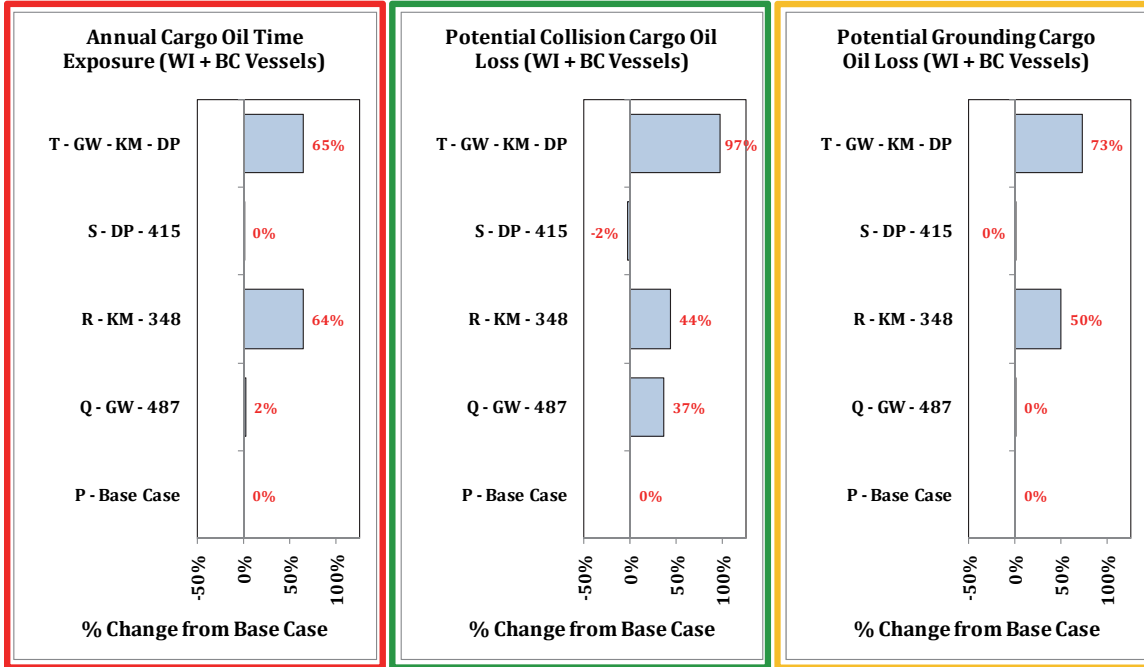

Figure 73. An overview comparison of the changes from the 2010 base case for each What-If scenario in terms of cargo oil movement exposure, POTENTIAL collision cargo oil loss, and POTENTIAL grounding cargo oil loss.

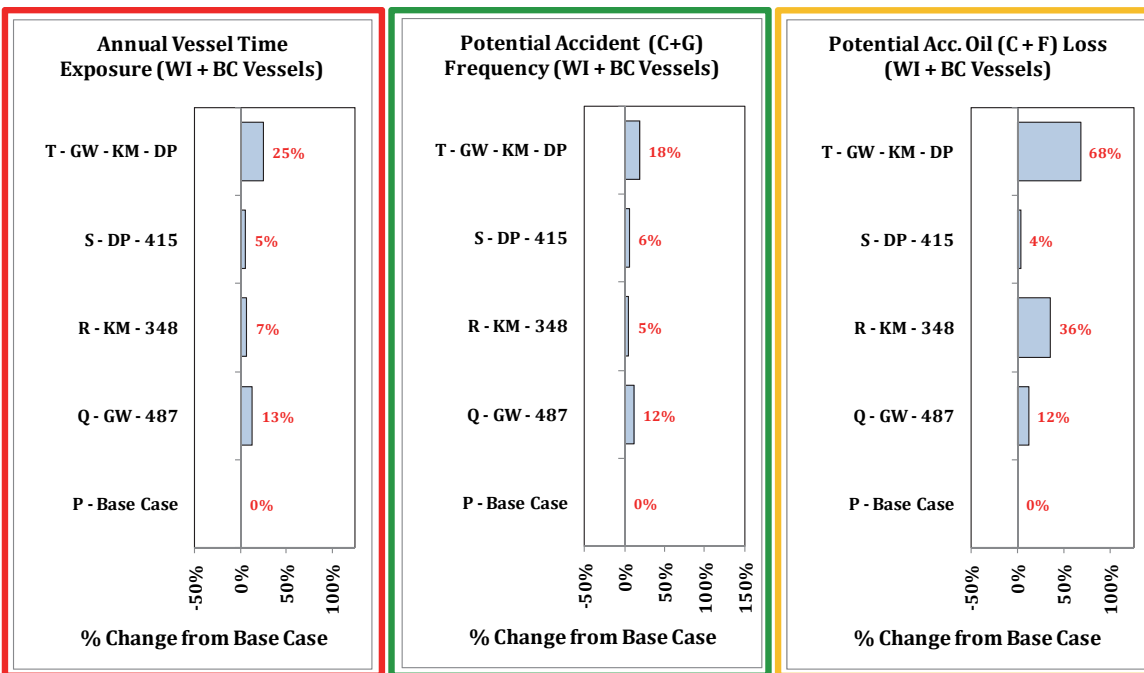

Figure 74. An overview comparison of the changes from the 2010 base case for each What-If scenario in terms of vessel time exposure, POTENTIAL accident frequency, and POTENTIAL accident oil loss.

three separate What-If scenarios combined gives $4\%+36\%+12\% = 52\%$. Hence, besides an additive effect of combining the three What-If scenarios an additional multiplier effect becomes apparent when all are assumed operational. Again such a multiplier effect could not be found without building a detailed simulation model of the system to capture additional interaction effects when simultaneously running traffic from the three What-If scenarios.

By waterway zone analysis results of What-If scenarios

Figure 80 through Figure 87 capture in geographic graphical detail the changes in POTENTIAL accident frequency and POTENTIAL oil outflow. These geographic profiles are presented in a 2D format and in a 3D format. Increases in risk in the 2D format are observed though a darkening of color when adding traffic, whereas changes in the 3D format are observed through the addition of peaks when adding traffic. One ought to exercise caution in drawing conclusions from these 3D profiles as at times a more concentrated high peak with a small base may contribute less to overall system risk than a smaller peak with larger wide base. To further interpret/observe/evaluate changes in risk we therefore aggregate the detailed information from the 2D and 3D geographic profiles by the 15 waterway zones outlined in Figure 1. The by waterway zone analysis results are summarized in the graphic format depicted in Figure 75 (which is the same as Figure 8 in the executive summary).

In turn, the combined changes of the 15 waterway zones yield the overall system-wide changes discussed previously in Figure 71 through Figure 74. Hence, the by waterway zone analysis is an information layer between the detailed visual explicit geographic risk profiles and a single system-wide risk number that described the percentage change in risk for the system as a whole. Both the by waterway zone analyses and system-wide analyses, however, use the geographic profile analyses as their input. The geographic profiles provide for a detailed nuanced visual evaluation of that single system-wide risk number and capture the complex changes in the distribution of system risk geographically when adding What-If traffic to the VTRA 2010 baseline scenario. The by waterway zone analyses depicted in Figure 76 through Figure 79 capture these complex changes locally. Below we firstly provide a detailed explanation of the by waterway zone analysis output format.

Explanation format of by Waterway Zone analysis results

Firstly consider the titles of the figure legend in Figure 75. The base case serves as the benchmark for the relative comparisons in Figure 75 and the base case system-wide POTENTIAL oil losses are set at 100%. In the combined What-If scenario (T) this increases by (+68%) and hence the total POTENTIAL oil loss evaluated for Case T equals $100\% + 68\% = 168\%$. Thus all percentages in Figure 75 are evaluated in terms of base case percentages. Hence, we have a system-wide increase by a relative multiplicative overall factor 1.68 in POTENTIAL oil outflow. Said differently, the POTENTIAL oil losses of the base case (100%) are multiplied by a factor 1.68 in case of Scenario T.

The blue bars in Figure 75 represent the percentage waterway zone contribution to POTENTIAL oil losses in the 2010 Base Case. The waterway zones are ranked in Figure 75 by the blue bar percentages. Hence, the largest percentage contribution of 17% to the Base Case (P) total POTENTIAL oil loss is observed for the Guemes waterway zone, the second largest 14.9% for the Rosario waterway zone, etc. If we sum all base case waterway zone percentages we arrive at 100%, that is:

$$17.0+14.9+13.4+10.0+10.0+9.8+9.8+4.8+4.8+3.9+0.6+0.4+0.2+0.2+0.1 = 100\%$$

The red bars in Figure 75 represent the percentage waterway zone contribution to POTENTIAL oil losses in the combined What-If scenario (T) in base case percentages. Hence, the Guemes waterway zone contributes 22.3% to the total 168% POTENTIAL oil outflow in Case T, the Rosario waterway zone contributes 15.5%, etc. If we sum all Case T waterway zone percentages we arrive at 168%, that is:

$$22.3+15.5+12.6+10.0+10.3+23.8+46.7+9.8+6.5+7.1+2.5+0.4+0.2+0.2+0.3 = 168\%$$

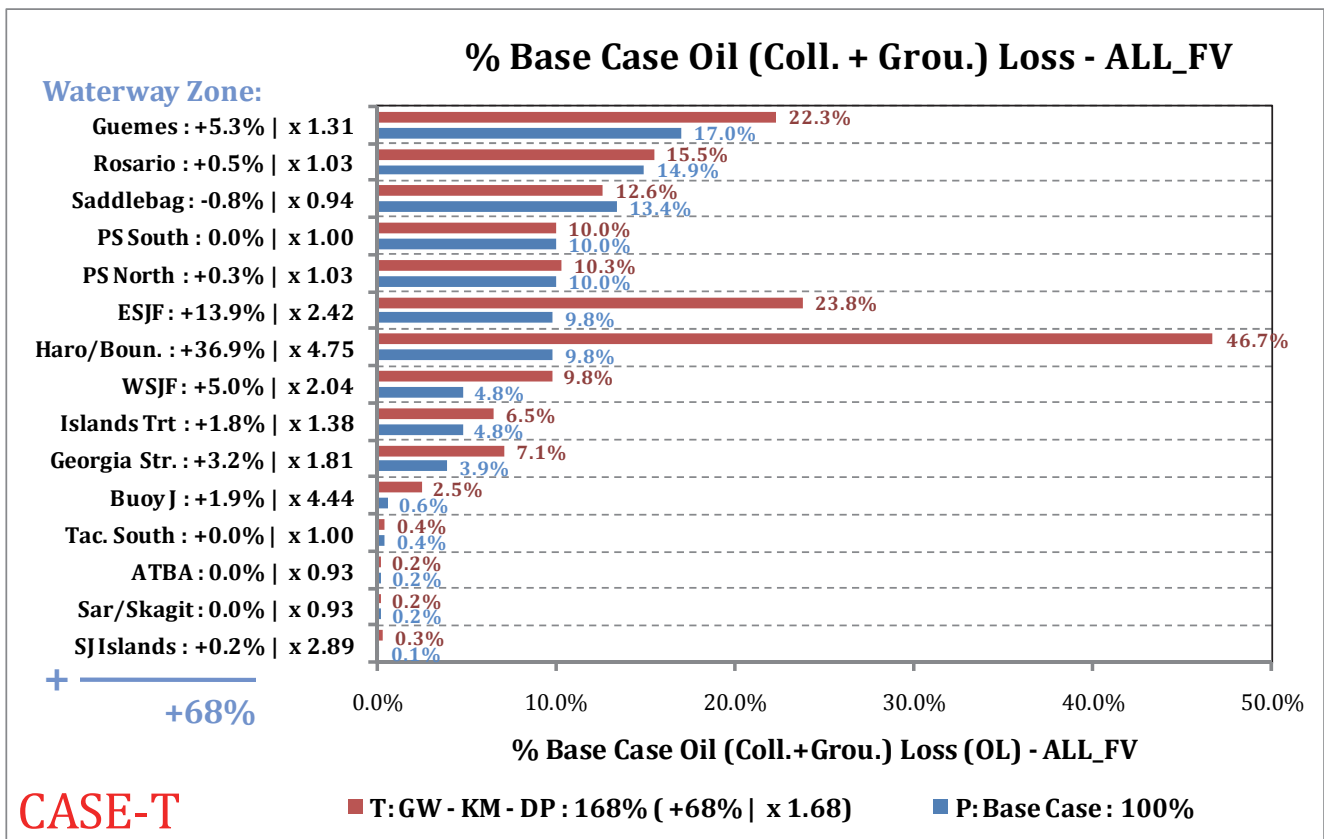

Figure 75. Relative comparison of POTENTIAL oil outflow by waterway zone. Blue bars show the percentage by waterway zone for the base case 2010 year, red bars show the percentage for Case T in terms of base case percentages. Absolute differences by waterway zone and relative multipliers by waterway zone are provided in the y-axis labels.

FINAL REPORT: VTRA 2010

Observe from Figure 75 that the Guemes waterway zone is not the largest contributor to system-wide POTENTIAL oil losses anymore in Case T. Instead the Haro-Strait/Boundary pass waterway zone is now the largest contributor, East-Strait of Juan de Fuca the second largest, etc.

Concentrating now on the y-axis labels, the absolute percentage changes are indicated to left. To the right a relative multiplicative factor is evaluated by waterway zone. For example, we have for the Guemes waterway zone:

$$22.3\%-17.0\% = +5.3\% \text{ and } 22.3\%/17.3\% = \times 1.31.$$

In other words, going from the Base Case (P) to the Combined What-If Scenario (T), the Guemes waterway zone experiences a +5.3% absolute increase in terms of system-wide base case percentage of POTENTIAL oil loss. This translates, going from Base Case (P) to the Combined What-If Scenario (T), into a multiplication for the Guemes waterway zone Base Case POTENTIAL oil loss by a relative multiplicative waterway zone factor 1.31. Similarly, we have for the Haro-Strait/Boundary Pass waterway zone:

$$46.7\%-9.8\% = +36.9\% \text{ and } 46.7\%/9.8\% = \times 4.75.$$

In other words, going from the base case (P) to the Combined What-If scenario (T) the Haro-Strait/Boundary Pass waterway zone experiences a +36.9% absolute increase measured in terms of system-wide base case percentage of POTENTIAL oil loss. This means that going from base case (P) to the Combined What-If Scenario (T), the base case POTENTIAL oil loss in the Haro-Strait/Boundary Pass waterway zone is multiplied by a relative waterway zone factor $\times 4.75$, etc.

By comparing the relative waterway zone factors one concludes which waterway zone experiences a larger share of the overall POTENTIAL oil loss increases normalized by waterway zone. For example, the Haro-Strait/Boundary Pass waterway zone ($\times 4.75$) comes first, second the Buoy J waterway zone ($\times 4.44$), third the San Juan Islands waterway zone ($\times 2.89$), fourth the East Strait of Juan de Fuca waterway zone ($\times 2.42$), etc. Waterway zones with a relative waterway zone factor larger than the relative system-wide factor ($\times 1.68$) experience, relatively speaking, a larger than system-wide effect of the What-If Scenario expansion and waterway zones with a relative waterway zone factor less than the relative system-wide factor ($\times 1.68$) experience, relative speaking, a smaller than system-wide effect of the What-If scenario expansion.

Finally, if we add the absolute percentage increases by waterway zone we arrive at the system-wide absolute percentage increase, i.e.:

$$5.3+0.5-0.8+0.0+0.3+13.9+36.9+5.0+1.8+3.2+1.9+0.0+0.0+0.0+0.2 = +68\%.$$

Thus, 8 out of the 15 waterway zones experience little to no effect in terms of POTENTIAL oil loss when all three expansion scenarios are operational. No doubt, such localized information helps in the design of a risk mitigation measures portfolio that aims to reduce these POTENTIAL increases.

Below we shall summarize by waterway zone results for the four different What-If Scenarios. We strongly encourage readers however to consult geographic profiles Figure 80 through Figure 87 to help further interpret the by waterway zone summary results in POTENTIAL accident frequency and POTENTIAL oil loss.

Gateway Terminal waterway zone results

The left panel of Figure 76 compares waterway zone accident frequency POTENTIAL in the base case against the Gateway What-If Scenario. Similarly the right panel compares a waterway zone's oil outflow POTENTIAL. The largest absolute increase in POTENTIAL accident frequency (+3.4%) is observed in the Georgia Strait waterway zone, which is predominantly an increase in POTENTIAL allision frequency which does not translate into additional potential oil outflow (see the right panel of Figure 76). This also constitutes the largest relative waterway zone increase of a factor 1.83 in POTENTIAL accident frequency.

From the right panel in Figure 76 one observes the largest absolute increase in POTENTIAL oil outflow (8.1%) in the Guemes waterway zone. Further analysis showed this to be a result of added interactions between oil barges and tank focus vessels in the Gateway What-If Scenario. Hence, this is an indirect effect/unintended consequence of adding Gateway traffic to the one-way Rosario zone, which overall changes the dynamic of the Base Case 2010 traffic behavior here in an adverse manner. Here too this constitutes the largest relative waterway zone increase of a factor of 1.48. Although the Buoy J waterway zone only contributes 0.6% to the overall total base case outflow POTENTIAL, it does experience the second largest relative waterway zone factor increase of 1.41.

Trans Mountain Pipeline waterway zone results

The left panel of Figure 77 compares waterway zone accident frequency potential in the base case against the Trans Mountain Pipeline What-If Scenario. Similarly the right panel compares a waterway zone's oil outflow potential. The largest absolute increase in POTENTIAL accident frequency (+1.6%) is observed in the Island Trust waterway zone defined on the title page. The largest relative waterway zone increase of a factor 1.21 in POTENTIAL accident frequency, however, is observed in the Buoy J waterway zone.

From the right panel in Figure 77 one observes the largest absolute POTENTIAL increase in oil outflow (+17.3%) in the Haro-Strait/Boundary pass waterway zone. Here, however this constitutes the largest relative waterway zone increase of a factor of 2.76. Notably, the East Strait of Juan de Fuca experiences an absolute increase in POTENTIAL oil outflow of 10.6% and a relative waterway zone increase factor of 2.08. Although the Buoy J waterway zone only contributes 0.6% to the overall total base case outflow POTENTIAL, it does experience the second largest relative waterway zone factor increase of 2.32.

It is important to realize here that base case oil loss is evaluated in the VTRA 2010 with respect to all focus vessels, i.e. bulk carriers, container vessels, other cargo vessels, chemical carriers, atb's, oil barges and tankers. If absolute increases and relative waterway zone increase factors would have been evaluated with respect to base case oil losses from tankers alone, relative waterway zone increase factors would be higher as one divides by a smaller amount of POTENTIAL oil loss (i.e. that of tankers alone, excluding the combined POTENTIAL oil loss from the other focus vessels).

Delta Port geographic waterway zone results

The left panel of Figure 78 compares waterway zone accident frequency POTENTIAL in the base case against the Delta Port What-If Scenario. Similarly the right panel compares a waterway zone's oil outflow POTENTIAL. The largest absolute increase in POTENTIAL accident frequency (+2.4%) is observed in the Guemes waterway zone, which, given that the Delta Port What-If focus vessels travel through Haro-Strait/Boundary Pass, has to be an indirect effect. The largest relative waterway zone increase factor 1.18 is observed in the Saddlebag waterway zone, which too is an indirect effect. Haro-Strait/Boundary Pass experiences an absolute effect increase of 1.7% and a relative waterway zone increase factor of 1.14. The latter can be considered direct effects of the Delta Port What-If Scenario.

From the right panel in Figure 78 one observes the largest absolute increase in POTENTIAL oil outflow (+3.8%) in the Haro-Strait/Boundary Pass waterway zone. Here too this constitutes the largest relative waterway zone increase of a factor of 1.38. Although the Buoy J waterway zone only contributes 0.6% to the overall total base case outflow POTENTIAL, it does experience the second largest relative waterway zone factor increase of 1.34.

Combined What-If scenario waterway zone results

The left panel of Figure 79 compares waterway zone accident frequency POTENTIAL in the base case against the Combined What-If Scenario (T). Similarly the right panel compares a waterway zone's oil outflow POTENTIAL. The largest absolute increase in POTENTIAL accident frequency (+4.4%) is observed in the Haro-Strait/Boundary Pas waterway zone. The largest relative waterway zone increase factor 1.89 is observed in the Georgia Strait waterway zone. Although the Buoy J waterway zone only contributes 0.4% to the overall total base case outflow POTENTIAL, it does experience the second largest relative waterway zone factor increase of 1.61 in POTENTIAL accident frequency.

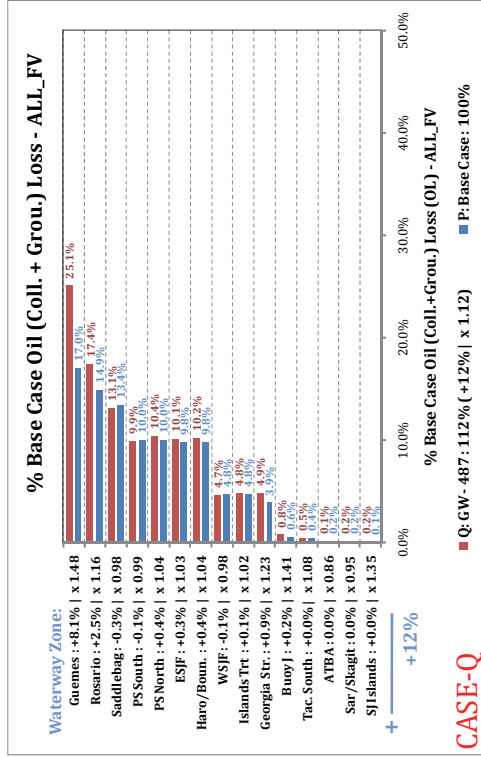
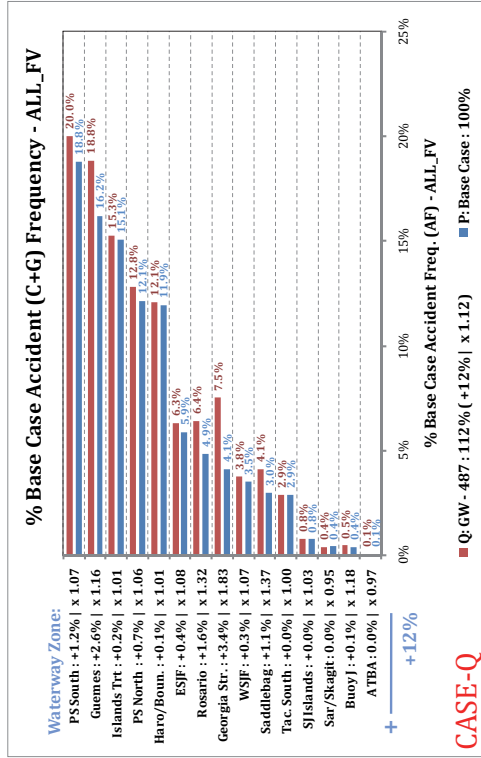

Figure 76. By waterway zone comparison of POTENTIAL accident frequency and POTENTIAL oil outflow of Case Q with Case P. For a detail explanation of output format see Page 97.

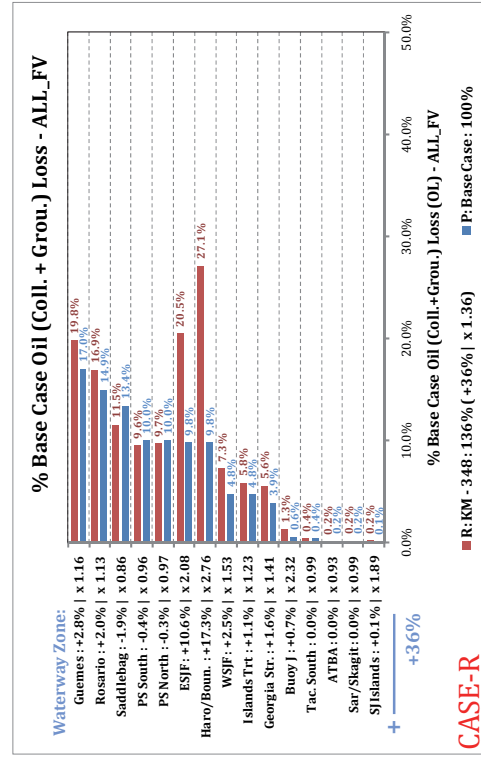
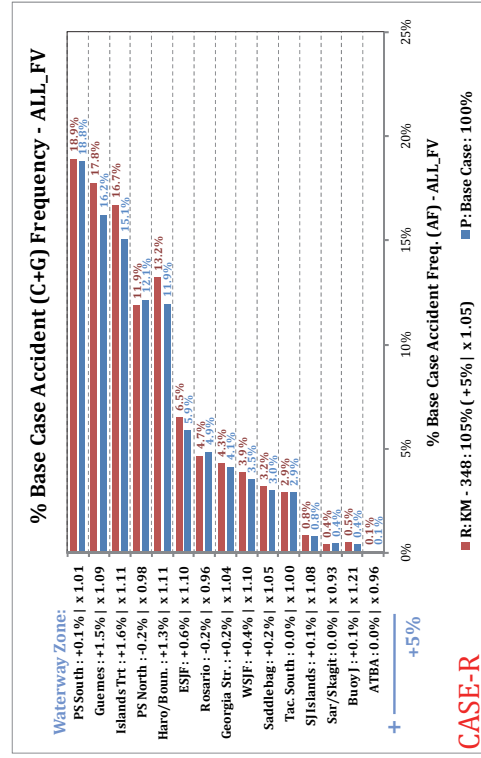

Figure 77. By waterway zone comparison of POTENTIAL accident frequency and POTENTIAL oil outflow of Case R with Case P. For a detail explanation of output format see Page 97.

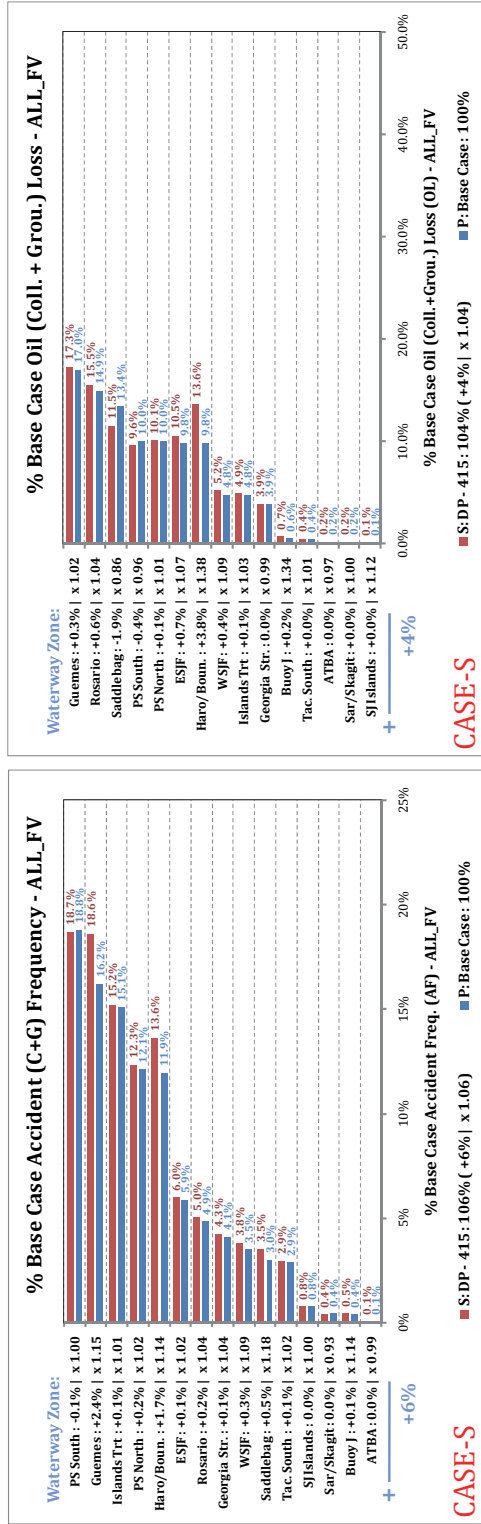

Figure 78. By waterway zone comparison of POTENTIAL accident frequency and POTENTIAL oil outflow of Case S with Case P. For a detail explanation of output format see Page 97.

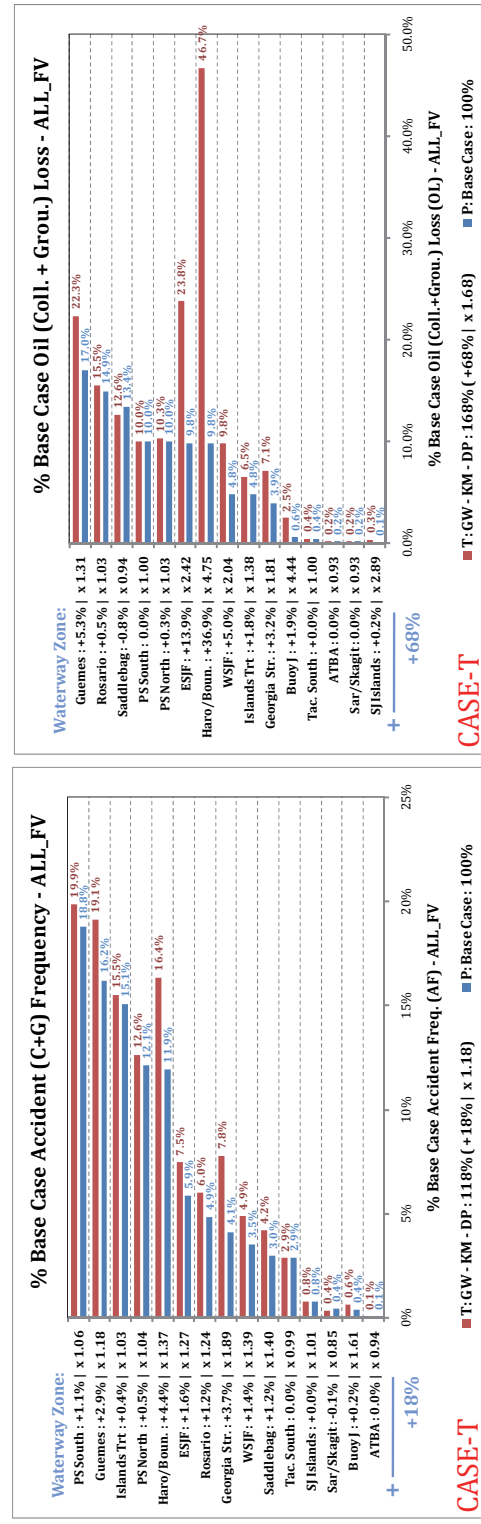

Figure 79. By waterway zone comparison of POTENTIAL accident frequency and POTENTIAL oil outflow of Case T with Case P. For a detailed explanation of output format see Page 97.

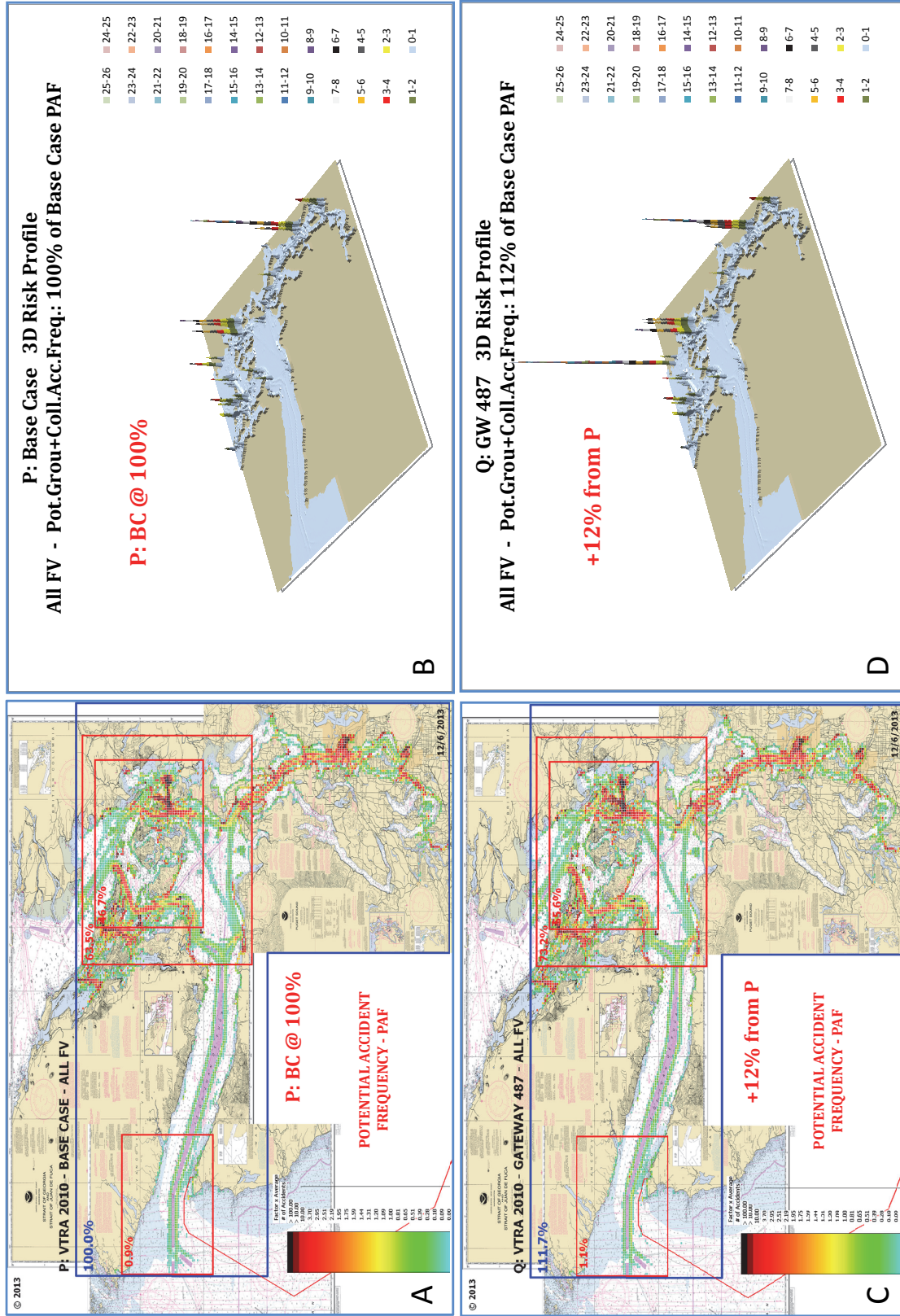

Figure 80. POTENTIAL accident frequency geographic profile comparison between Case P and Case Q.

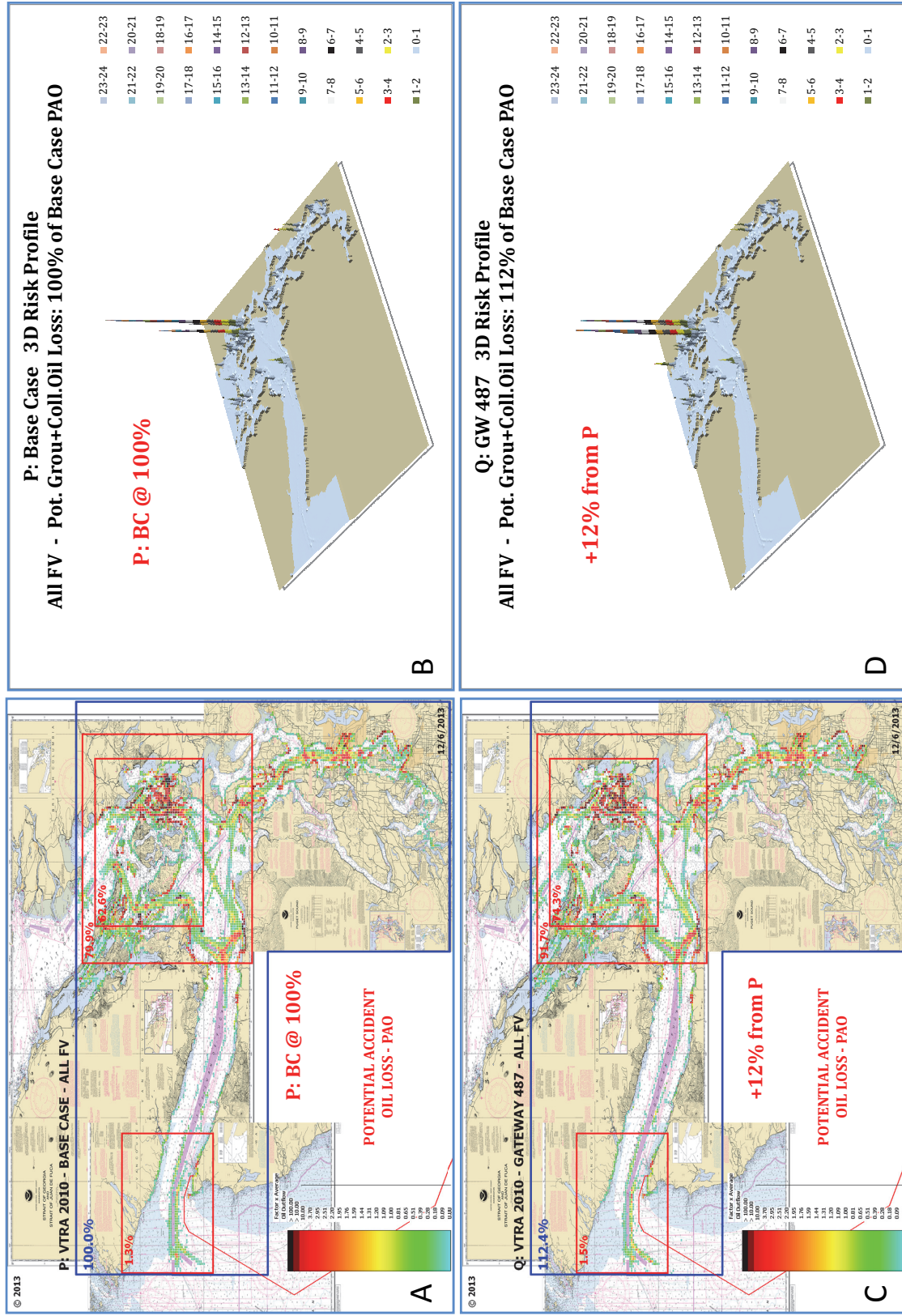

Figure 81.POTENTIAL oil outflow geographic profile comparison between Case P and Case Q.

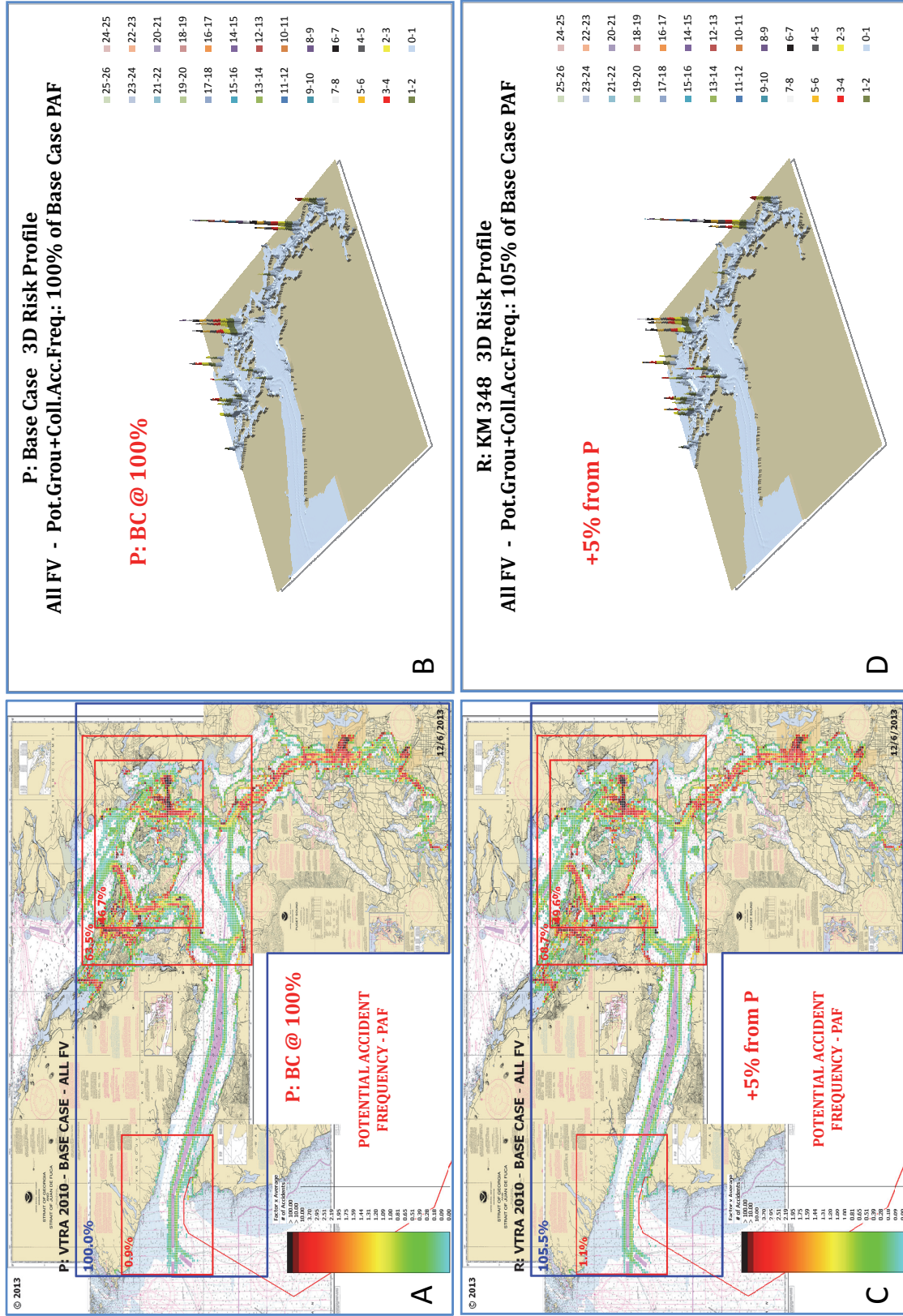

Figure 82.POTENTIAL accident frequency geographic profile comparison between Case P and Case R.

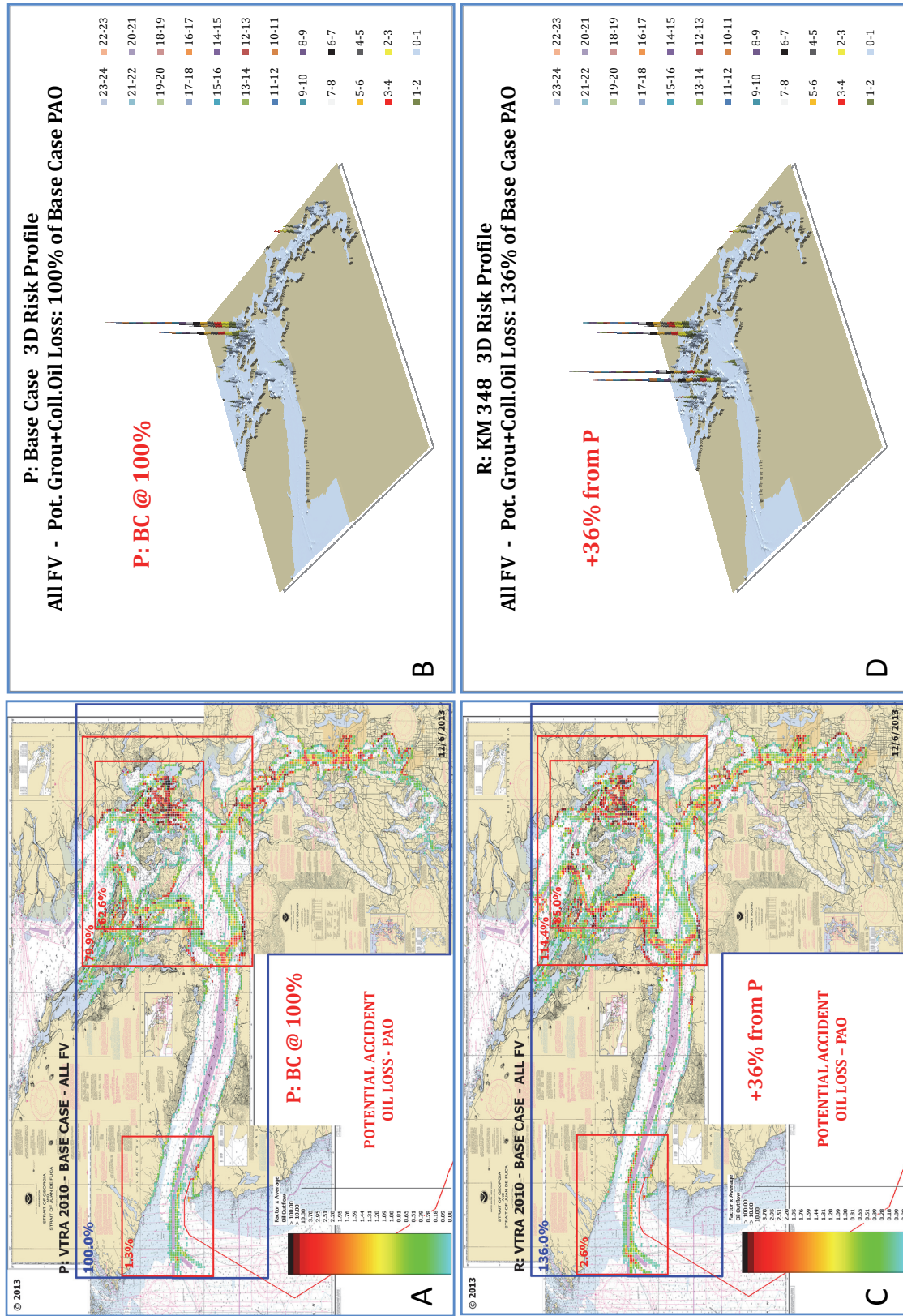

Figure 83. POTENTIAL oil outflow geographic profile comparison between Case P and Case R.

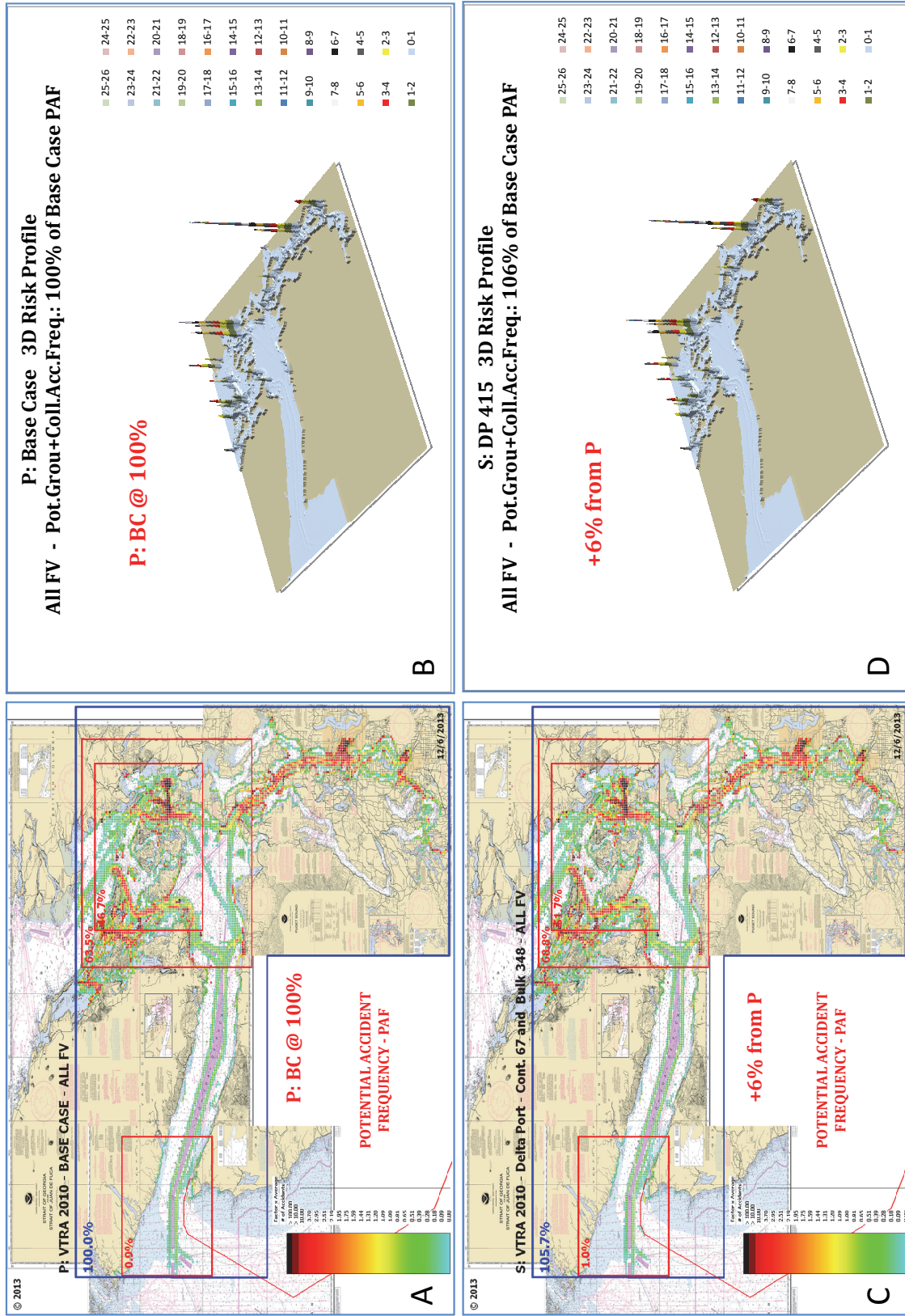

Figure 84. POTENTIAL accident frequency profile comparison between Case P and Case S.

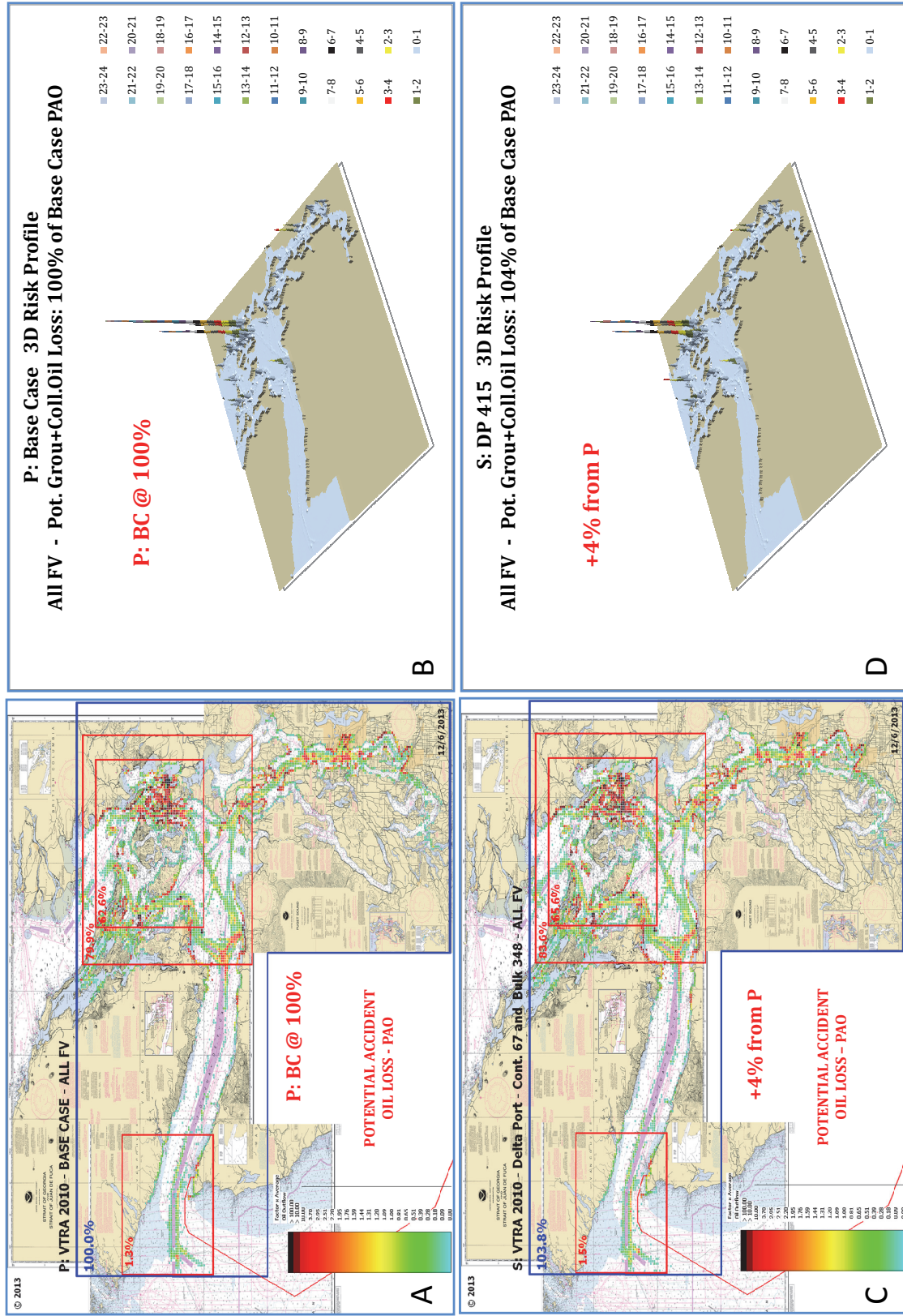

Figure 85. POTENTIAL oil outflow geographic profile comparison between Case P and Case S.

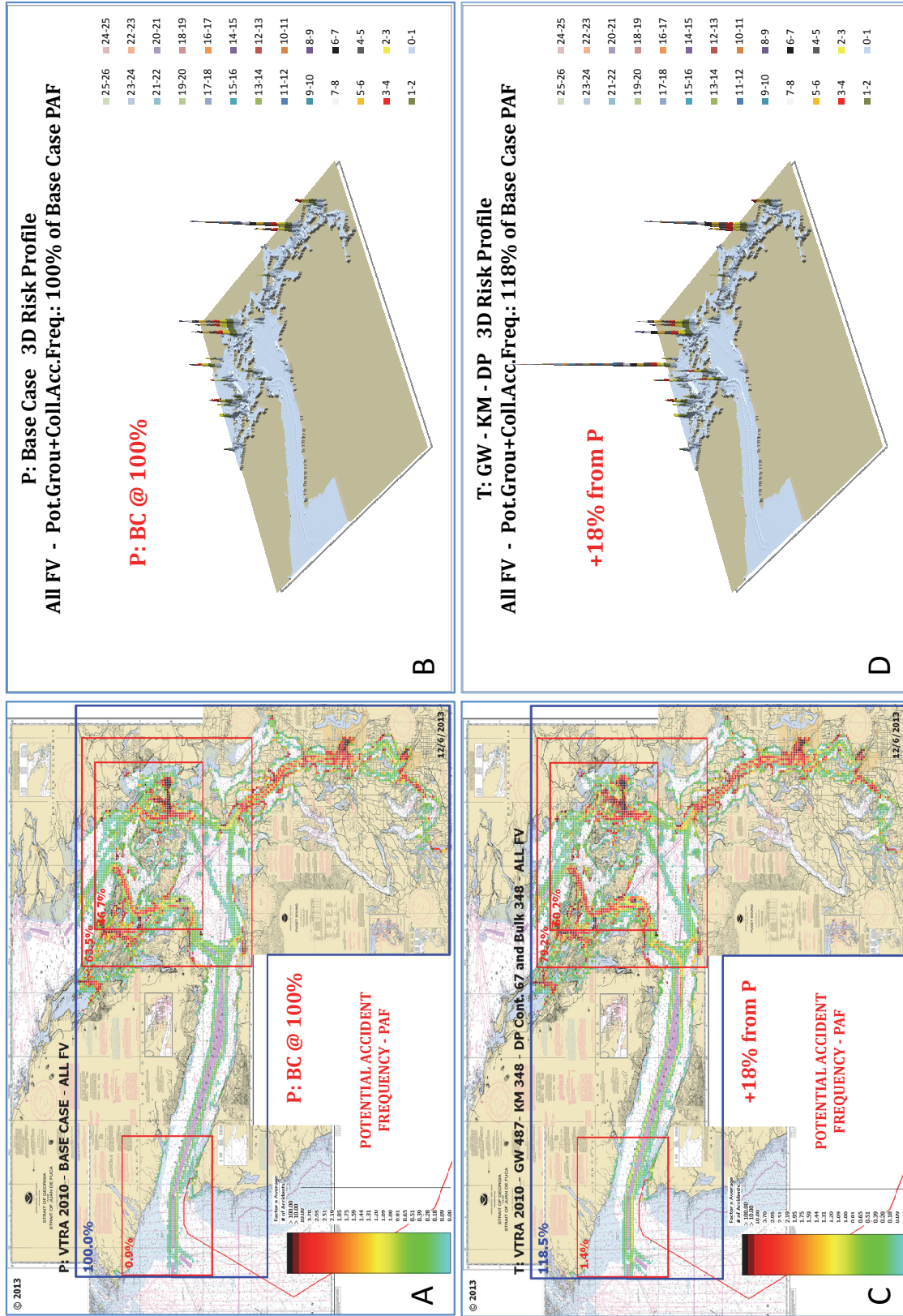

Figure 86. POTENTIAL accident frequency geographic profile comparison between Case P and Case T.

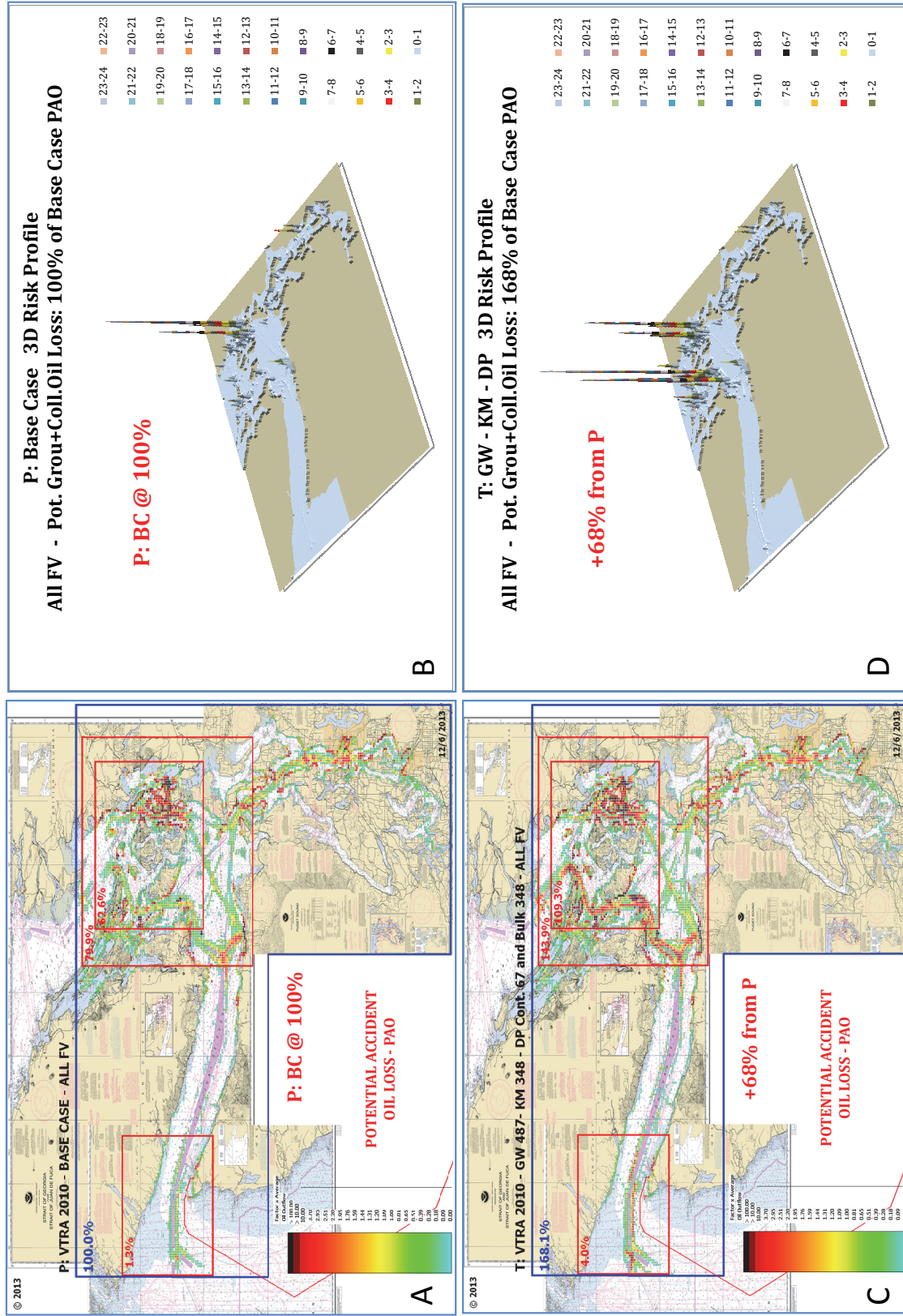

Figure 87. POTENTIAL oil outflow geographic profile comparison between Case P and Case T

FINAL REPORT: VTRA 2010

From the right panel in Figure 79 one observes the largest absolute increase in POTENTIAL oil outflow (+36.9%) in the Haro-Strait/Boundary Pass waterway zone. Here this constitutes the largest relative waterway zone increase of a factor of 4.75. Once more, although the Buoy J waterway zone only contributes 0.6% to the overall total base case outflow POTENTIAL, it does experience the second largest relative waterway zone factor increase of 4.44.

FINAL REPORT: VTRA 2010

8. RMM SCENARIOS

In coordination with the VTRA 2010 Steering Committee a number of Risk Mitigation Measures (RMM) were proposed listed in Table 12. While some were informed or suggested by the analysis results from the What-If scenarios described in Chapter 7 others were suggested as measures currently in place or under consideration.

Table 12. Descriptors and short description of Risk Mitigation Measure (RMM) scenarios modeled in VTRA 2010

CASE P - RISK MITIGATION MEASURE (RMM) ANALYSIS	
P - BC & DH100	Base Case year with 100% double hull fuel tank protection for Cargo Focus Vessels
P - BC & HE00	Base Case Year with 50% human error reduction on Oil Barges
P - BC & HE50	Base Case Year with 100% human error reduction on Oil Barges
P - BC & CONT17KNTS	Base Case Year with max speed of 17 knots for container ships
CASE Q - RISK MITIGATION MEASURE (RMM) ANALYSIS	
Q - GW 487 & NB	Gateway expansion scenario and no bunkering support
Q - GW 487 & NB & OH	Gateway expansion scenario and no bunkering support and traversing only Haro routes
CASE T - RISK MITIGATION MEASURE (RMM) ANALYSIS	
T - GW - KM - DP & OW ATB	Case T with ATB's adhering to one way Rosario traffic regime
T - GW - KM - DP & EC	Case T with Cape Class bulk carrier given benefit of+ 1 escort on Haro and Rosario routes
T - GW - KM - DP & EH	Case T with all Focus Vessels given benefit of +1 escort vessel on Haro routes
T - GW - KM - DP & ER	Case T with Cape bulkers, laden Tankers, ATB's given benefit of +1 esc. on Rosario routes
T - GW - KM - DP & 6RMM	Case T with benefit OW ATB, EH, ER, P-HE50, Q-NB and P-CONT17 KNTS

Modeling the Risk Management Scenarios

Risk mitigation measures currently in place or being considered were evaluated by implementing them on the VTRA 2010 Base Case scenario. For example, the RMM Scenario P-BC & 17knots was evaluated on the base case (P) as the max 17 knots speed for container vessels is currently practiced in parts of the VTRA 2010 study area. The RMM Scenario P-BC & 17knots implements a max speed of 17 knots in the VTRA 2010 model for container vessels throughout the entire VTRA study area. Similarly, currently about 40% of Cargo Vessels have double hull fuel protected tanks and was modeled as such in the VTRA 2010 base case analysis. The RMM Scenario P-BC & DH100 assumes that double hull protected fuel tanks are in effect in the VTRA 2010 model for all (100%) of the Cargo Focus Vessels.

A risk mitigation measure that adds one additional person on the bridge of oil barges in US waters is currently under consideration. While it is not clear how much a reduction this would provide in

FINAL REPORT: VTRA 2010

terms of the human error incident category, two risk mitigation measures scenarios P-BC & HE50 and P-BC & HE00 attempt to bound the POTENTIAL benefit of implementing such a risk mitigation measure. The P-BC & HE50 RMM scenario applies a 50% reduction of the human error incident probability for oil barges across the entire VTRA study area within the VTRA 2010 model. The P-BC & HE00 RMM scenario applies a 100% reduction of the human error incident probability on oil barges. Hence, the analysis results for the P-BC & HE00 RMM scenario ought to be interpreted as a maximum POTENTIAL benefit analysis, whereas the P-BC & HE50 RMM scenario can be interpreted as a conservative evaluation of its POTENTIAL benefit.

The Q - GW 487 & NB RMM scenario in Table 12 was motivated by the observation in Figure 59 that a large part of the overall POTENTIAL collision accident frequency is attributed to oil barges. Given that the Gateway What-If Scenario provides for bunkering support for the additional Gateway vessels combined with the latter collision frequency observation, makes the Q - GW 487 & NB RMM scenario a natural RMM Scenario to be tested. Moreover, the observations in Figure 59 and Figure 60 that a larger part of the POTENTIAL collision accident frequency and POTENTIAL collision oil loss are observed in the Rosario Strait waterway zone, gives rise to the question if it would be a good idea for the added Gateway bulk carriers to avoid this waterway zone and travel solely to and from the planned Gateway Terminal through Haro-Strait/Boundary Pass. If that option were followed, bunkering at Vendovi Anchorage appears to be less meaningful and hence in the Q - GW 487 & NB & OH RMM scenario Gateway bunkering support is also removed from the Gateway What-If Scenario Q - GW 487.

Figure 88 demonstrates the difference in modeling the Gateway What-If focus vessels across these scenarios. Figure 88A depicts the travel time exposure of the Gateway What-If focus vessels for the What-If scenario Q: GW 487. Please observe from Figure 88A the larger spike at the Vendovi anchorages area (see also Figure 66) as a result of Gateway bulk carriers slowing down to anchor. Also observe in Figure 88A the vessel time exposure of oil barges travelling north and south in the Puget Sound. In Figure 88B one observes that the bunkering transits have been removed in the Q: GW 487 & NB RMM scenario as well as the transits of the Gateway bulk carriers to the Vendovi anchorages. In Figure 88C one observes that in the Q: GW 487 & NB & OH RMM scenario Gateway bunkering support has been removed and that Gateway bulk carriers now solely travel through Haro-Strait/Boundary Pass in the VTRA 2010 model.

The T-GW-KM-DP & OW ATB RMM Scenario in Table 12 addresses perhaps a lingering question in the Puget Sound stakeholder community; Would it be beneficial if articulated tug barges would also be subjected to the one-way zone regime in Rosario Strait? Since the inclusion of ATB's can cause additional delays for other vessels destined to travel through Rosario-Strait it seemed prudent to test this risk mitigation measure on the combined What-If Scenario with all three expansion projects assumed operational (i.e. test it on the What-If Scenario with the highest traffic levels added to the 2010 Base Case). The RMM measure T-GW-KM-DP & OC Scenario was

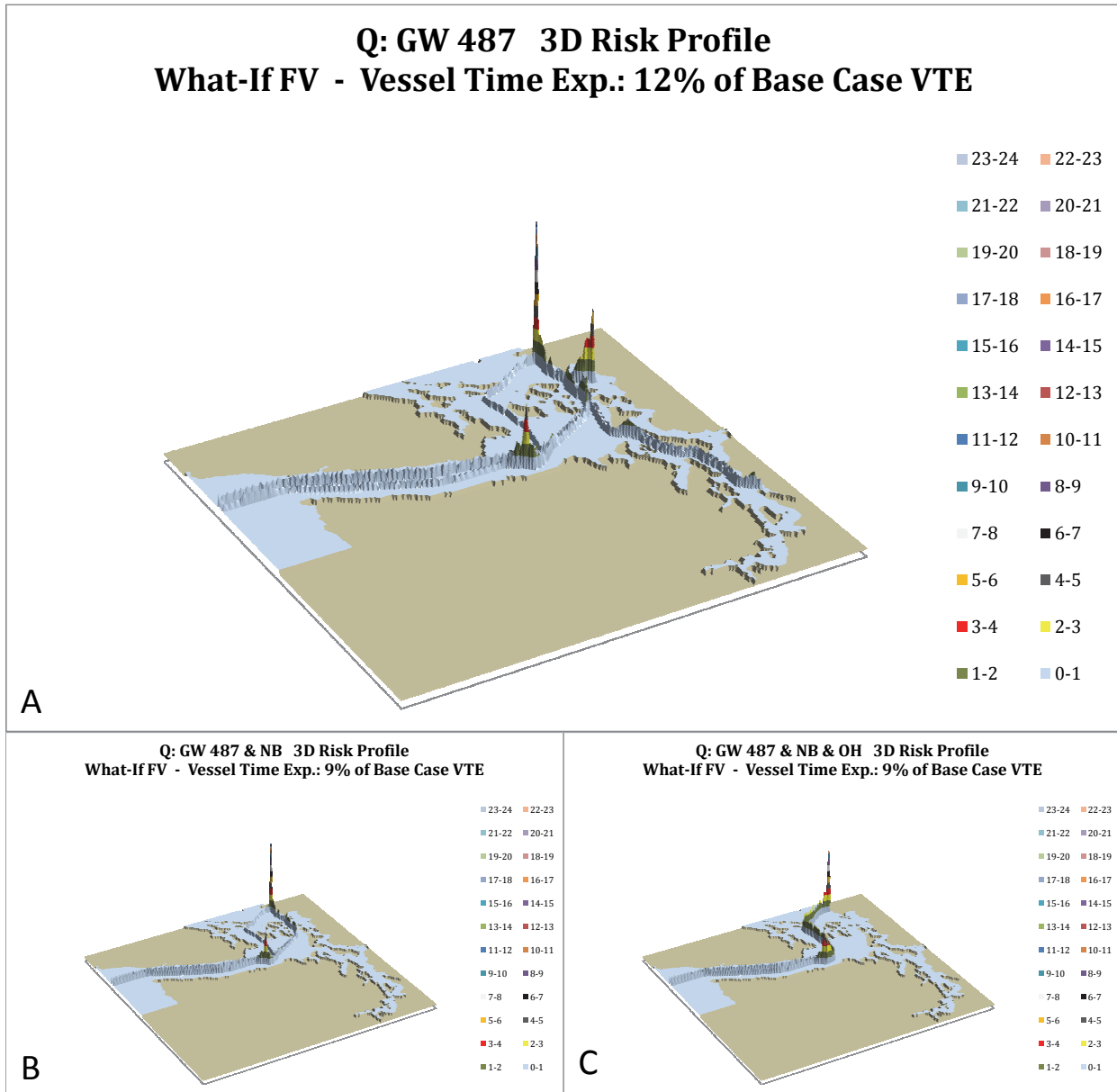

Figure 88. Vessel time exposure of Gateway What-If focus vessels under three Gateway Scenarios

motivated by the observation that currently no Cape Class bulker size vessels travel through the VTRA study area and given their size it would seem prudent to consider these Gateway destined vessels be escorted, at least at first. The RMM measure T-GW-KM-DP & EH Scenario was motivated primarily by the Trans Mountain Pipeline What-If Scenario analysis results depicted in Figure 86 and Figure 87. In Figure 86 and Figure 87 larger increases in POTENTIAL accident frequency and POTENTIAL oil outflow are observed in the Haro-Strait/Boundary Pass waterway zone. These

results prompted the question amongst steering committee members if pre-positioning of a rescue escort tug within this waterway zone would make sense. An advantage of pre-positioning over direct escorting is that other vessels also would receive the benefit of a pre-positioned escort tug. Moreover, pre-positioning would not result in an increase of traffic in this waterway zone and elsewhere as a result of escort vessels travelling to and from their destined vessels in the case of direct escorting. Pre-positioning has as its disadvantage however that the response time of the pre-positioned tug tends to be longer than that of a tug directly escorting a vessel. The VTRA 2005 model accommodates for the inclusion of one to two escort vessels within its accident probability model. Hence, to mimic the maximum potential benefit that prepositioning in the Haro-Strait/Boundary pass waterway zone could have, one additional escort vessel was assigned to all focus vessels on Haro-Strait/Boundary pass routes, i.e. to bulk carriers, container ships, chemical carriers, tankers, atb's and oil barges. The green area depicted in Figure 89 defines the location where the (+1) escort assumption in the VTRA 2010 accident probability model is in effect for the T-GW-KM-DP & EH RMM Scenario.

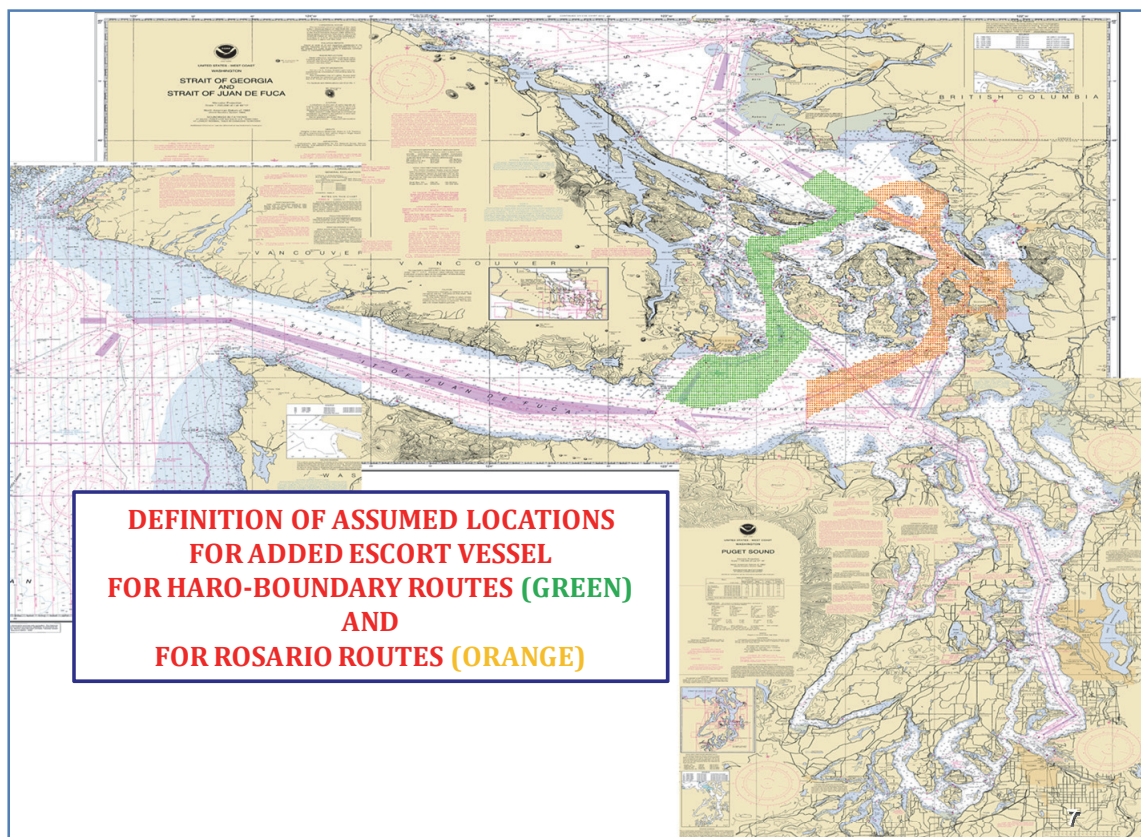

Figure 89. Definition of areas for escorting RMM scenario analyses in the VTRA 2010 model.

FINAL REPORT: VTRA 2010

As a matter of curiosity, the analysis team also modeled an escorting scenario for the Rosario bound routes with descriptor T-GW-KM-DP & ER. Here, one additional escort would be assumed available in the VTRA 2010 accident probability model for laden tankers, laden chemical carriers and laden ATB's as well as inbound and outbound Cape Class Gateway bulkers. The area where the additional escorting would be assumed in effect for the T-GW-KM-DP & ER scenario is defined as the orange area in Figure 89.

Finally, the T-GW-KM-DP & 6RMM scenario evaluates the POTENTIAL benefit of a portfolio of risk mitigation measures being operational at the same time. The RMM's included in this portfolio are:

1. ATB's also obey the one way Rosario regime
2. Escorting on Haro-Strait/Boundary Pass routes as defined for T-GW-KM-DP & EH
3. Escorting on Rosario routes as defined for T-GW-KM-DP & ER
4. The 17knots max speed rule applied to container vessels in the VTRA study area
5. A 50% human error reduction for Oil barges travelling throughout the VTRA study area
6. Bunkering support for Gateway vessels removed from VTRA 2010 model

Needless to say, other portfolios/combinations of RMM's could have been selected to evaluate the POTENTIAL benefit of a set of RMM's being operational at the same time. While it would appear that potential individual benefits of RMM measure are additive, a more prudent approach toward POTENTIAL benefit analysis is to model them operational at the same time in the VTRA 2010 model to account for potential negative/positive synergistic effects.

Summary of RMM Scenarios Results enacted on Base Case P

Figure 90 depicts the summary analysis results of the POTENTIAL effectiveness of the RMM scenarios enacted on the VTRA 2010 Base Case (P). The effectiveness is evaluated in terms of vessel time exposure, accident frequency and oil outflow. The analysis results in Figure 90 demonstrate that different RMM's may affect different points along the oil spill accident event chain depicted in Figure 3. Note that the P-BC & CONT 17KNTS RMM scenario affects all three metrics, i.e. vessel time exposure, POTENTIAL accident frequency and POTENTIAL oil loss. The RMM scenario's P-BC & HE50 and P-BC & HE00 do not affect vessel time exposure, but do affect the POTENTIAL accident frequency and the POTENTIAL oil loss and finally, the P-BC & DH100 scenario only affects the POTENTIAL oil loss. From Figure 90 it follows that despite the expected increase of vessel time exposure (+4%) as a result of slowing down the container vessels, the POTENTIAL accident frequency reduces by (-4%). The POTENTIAL oil outflow reduction of slowing down the containers vessels is evaluated at (-6%). Both P-BC & HE50 and P-BC & HE00 RMM's Scenario's are most effective amongst the RMM scenario's in Figure 90 in reducing the POTENTIAL accident frequency, whereas the P-BC & DH100 scenario is most effective in terms of reducing POTENTIAL oil outflow. In risk management, however, we believe the question is not so much "which risk mitigation measure to implement?", but more which portfolio of risk mitigation

measures. In designing a portfolio of risk mitigation measures we advocate the application of a “defense-in-depth” principle by selecting risk mitigation measures that address all three drivers of POTENTIAL oil loss, i.e. vessel time exposure, POTENTIAL accident frequency given exposure and POTENTIAL oil loss given an accident has occurred.

P - RMM SCENARIO REFERENCE POINT				
	Vessel Time Exposure (VTE)	Oil Time Exposure (OTE)	Pot. Accident Frequency (PAF)	Pot. Oil Loss (POL)
P - Base Case	100%	100%	100%	100%

CASE P - RISK MITIGATION MEASURE (RMM) ANALYSIS	
P - BC & DH100	Base Case year with 100% double hull fuel tank protection for Cargo Focus Vessels
P - BC & HE00	Base Case Year with 50% human error reduction on Oil Barges
P - BC & HE50	Base Case Year with 100% human error reduction on Oil Barges
P - BC & CONT17KNTS	Base Case Year with max speed of 17 knots for container ships

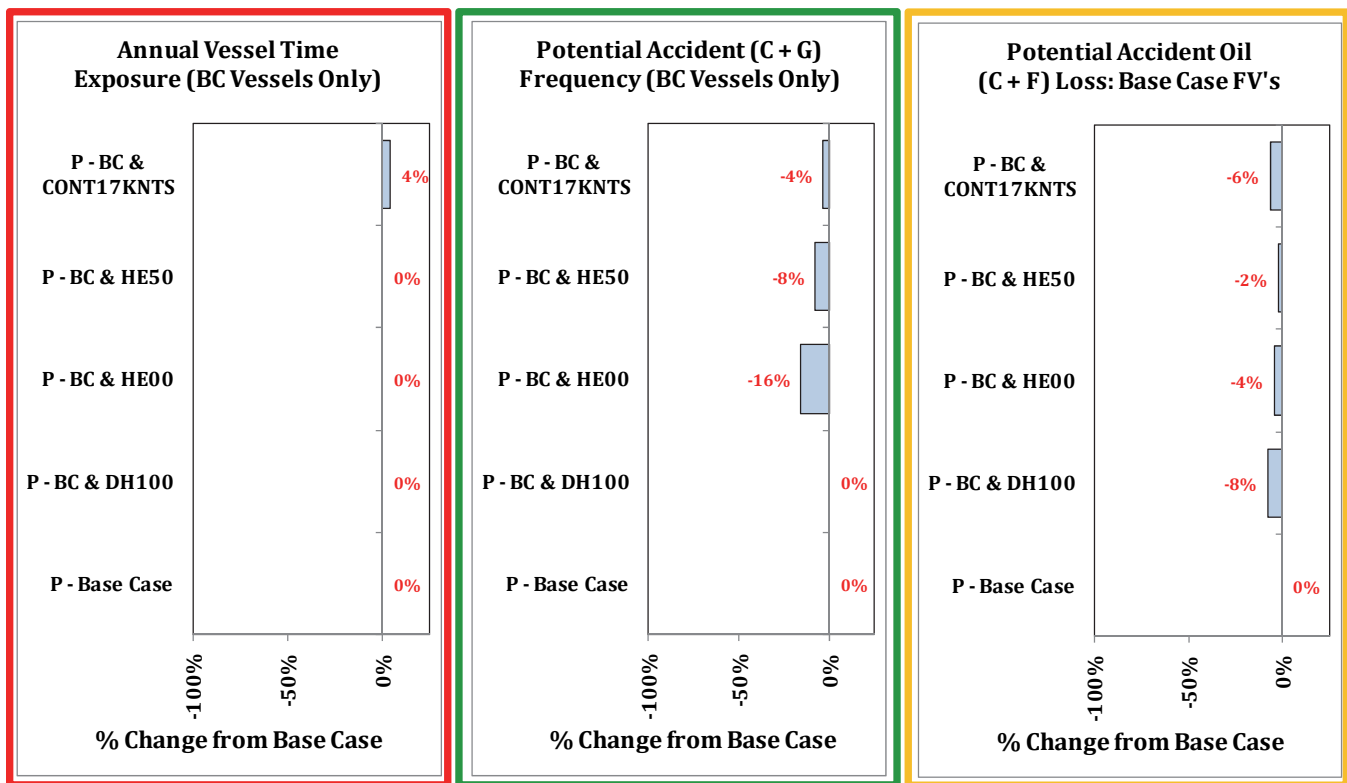

Figure 90. Summary Analysis results of RMM Scenario Analysis enacted on the base case (P).

By waterway zone analysis results of RMM measures enacted on base case (P)

Figure 91 provides a by waterway zone comparison of risk reduction effectiveness in terms of POTENTIAL accident frequency. Figure 92 provides a by waterway zone comparison of risk reduction effectiveness in terms of POTENTIAL oil loss. Observe from Figure 91 that by waterway

zone the P-BC & DH100 RMM scenario has no effect in terms of reducing accident frequency (as to be expected), whereas we observe from Figure 92 a risk reduction in all waterway zones in terms of POTENTIAL oil outflow except for the waterway zones Guemes, Saddlebag and Rosario (where a relative low number of cargo focus vessels traverse). For the other waterway zones the P-BC & DH100 RMM scenario has a virtually across the board reduction effect in terms of POTENTIAL oil loss. In fact, six out of the remaining twelve have relative risk reduction waterway zone factors less than 0.85¹².

Observe from Figure 91 and Figure 92 that the largest absolute risk reduction of the P-BC & CONT17KNTS scenario is attributed to the waterway zone Puget Sound North. In the Puget Sound North also the largest relative waterway reduction factor (0.73) is observed in terms of POTENTIAL oil outflow. In other words, limited to the Puget Sound North POTENTIAL oil outflow the 17 knots speed restriction has a 27% risk reduction effect. A large part of vessel to vessel interactions in the Puget Sound North in the VTRA 2010 model are oil barge – container vessel interactions.

Finally, from Figure 91 one observes an across the board risk reduction effect in terms of POTENTIAL accident frequency in the P-BC & HE00 scenario (and similarly the P-BC & HE50) scenario. The largest absolute risk reductions in POTENTIAL accident frequency of about 2% or higher are observed in those waterway zones where oil barges predominantly travel, i.e. the Puget Sound South, Guemes, Islands Trust and Puget Sound North waterway zones. In the Tacoma South waterway zone the most beneficial relative waterway zone risk reduction factor of 0.74 is observed¹³.

Summary of RMM Scenarios Results enacted on Gateway Terminal Case

Figure 90 depicts the summary analysis results of the POTENTIAL effectiveness of the RMM scenarios enacted on the VTRA 2010 Gateway What-If scenario (Q). The absolute effectiveness is evaluated in terms of vessel time exposure, accident frequency and oil outflow in terms of base case percentages. Absolute differences, however, are evaluated in Figure 90 as reductions from Case Q. One observes from Figure 90 about a 5% reduction in vessel time exposure by removing oil bunkering support, resulting in similar reductions in POTENTIAL accident frequency. Most notably, however, is the 10% reduction in POTENTIAL oil outflow in the Q – GW487 & NB RMM scenario. That is, twice the reduction in vessel time exposure and POTENTIAL accident frequency when removing oil bunkering support from the Gateway What-If Scenario. Overall one observes that it appears to be more beneficial for Gateway bulk carriers to have the option to travel using the Rosario Strait routes (The Q – GW487 & NB RMM scenario) than limit their travel to only using the Haro-Strait Boundary pass routes (The Q – GW487 & NB & OH RMM scenario).

¹² Hence, in these waterway zones the RMM has a 15% reduction effect or more in POTENTIAL oil loss.

¹³ Hence, in this waterway zone the RMM has a 26% risk reduction effect in POTENTIAL accident frequency.

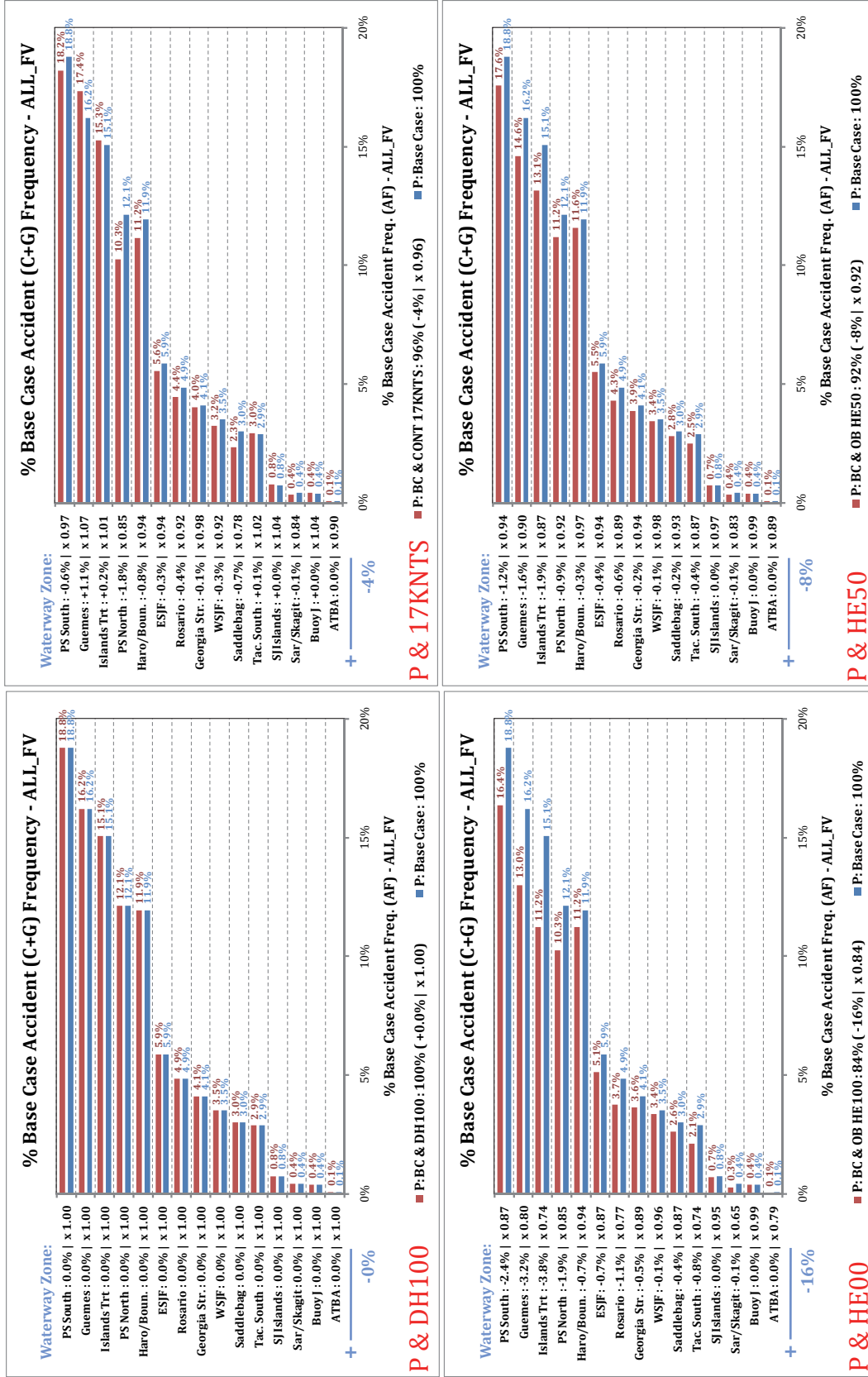

Figure 91. Waterway zone POTENTIAL accident frequency results comparison of RMM's enacted on base case (P). For a detailed explanation of output format see Page 97.

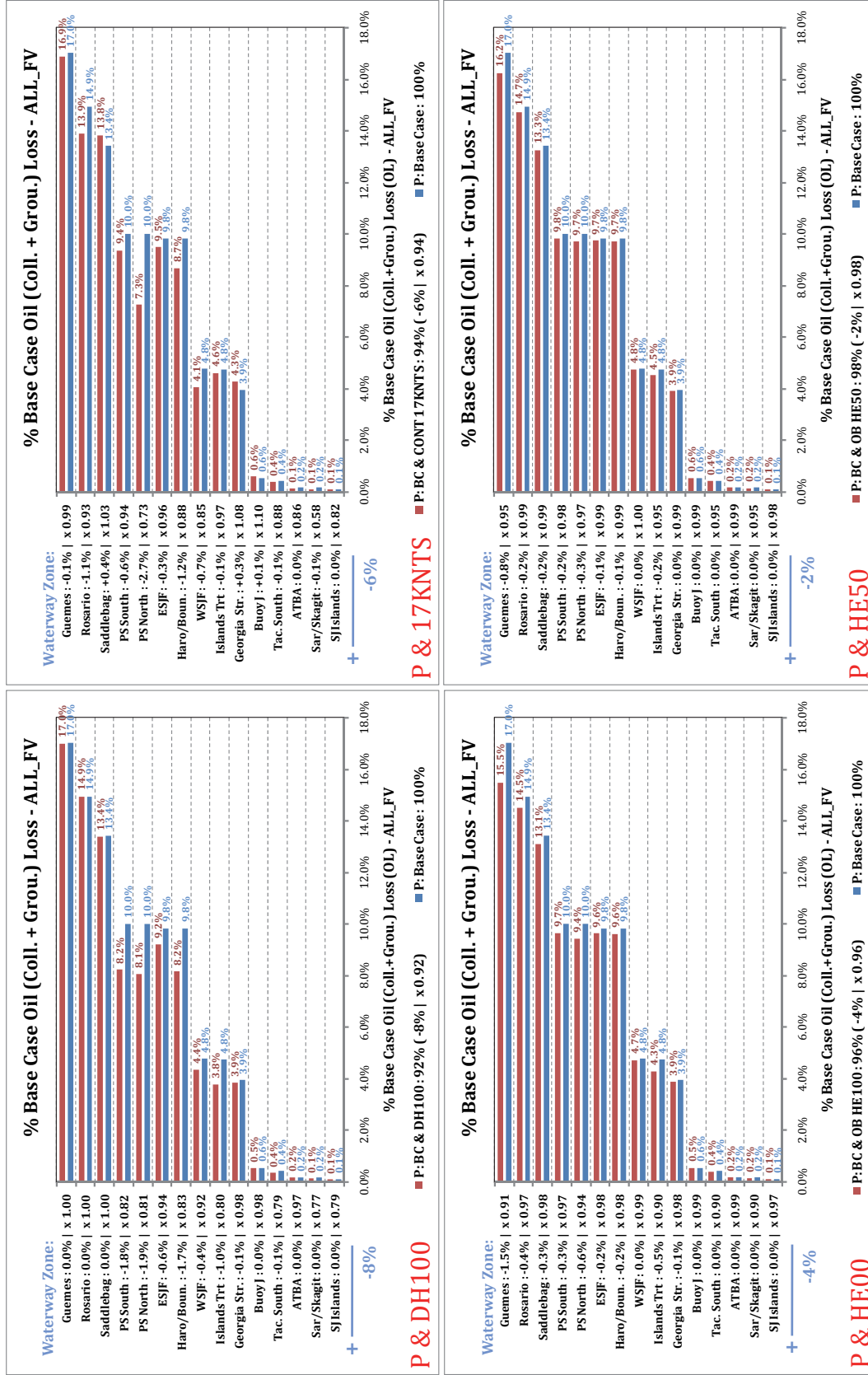

Figure 92. Waterway zone POTENTIAL oil outflow results comparison of RMM's enacted on base case (P). For a detailed explanation of output format see Page 97.

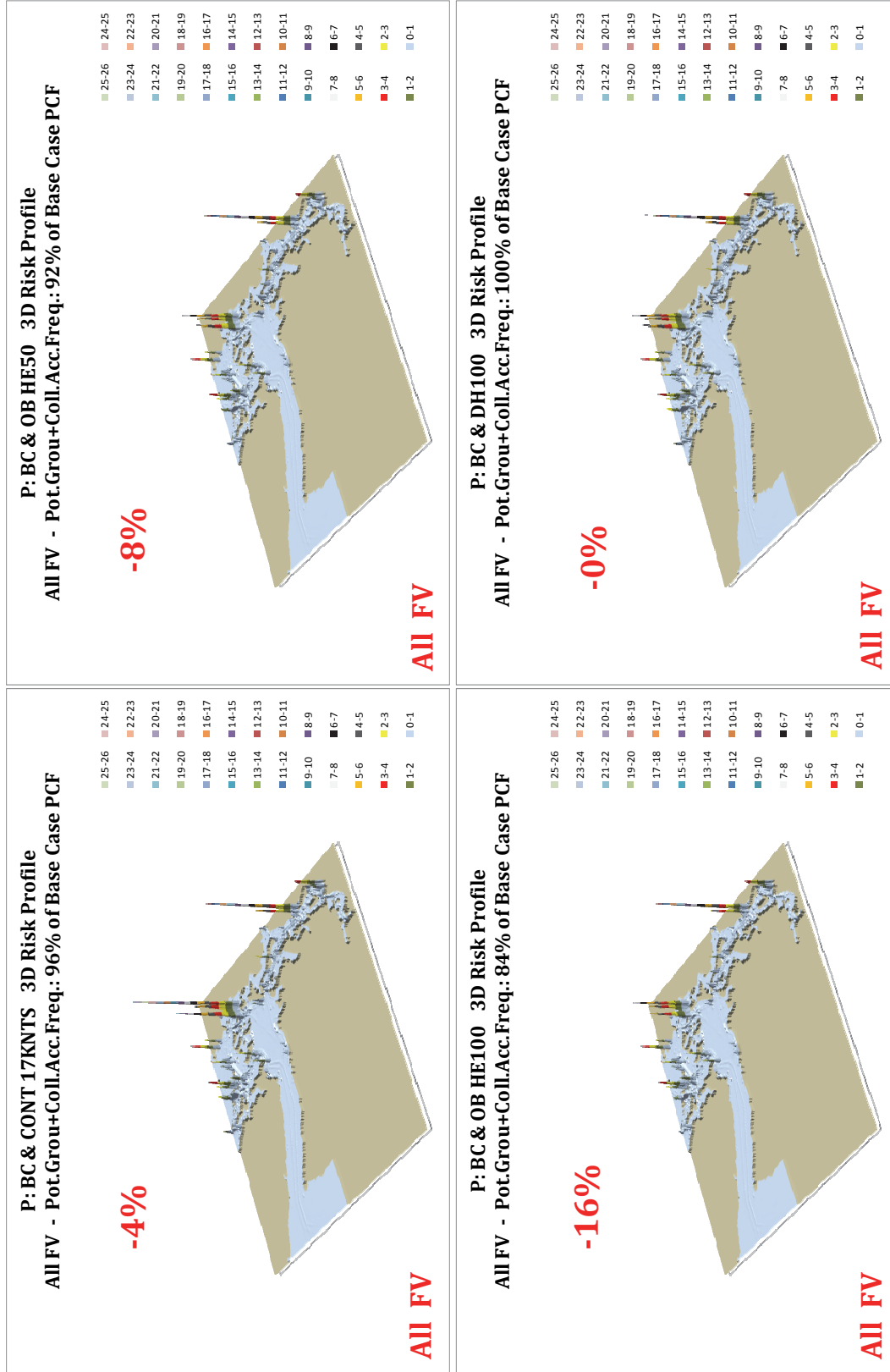

Figure 93. 3D geographic profile POTENTIAL accident frequency results of RMM's enacted on base case (P)

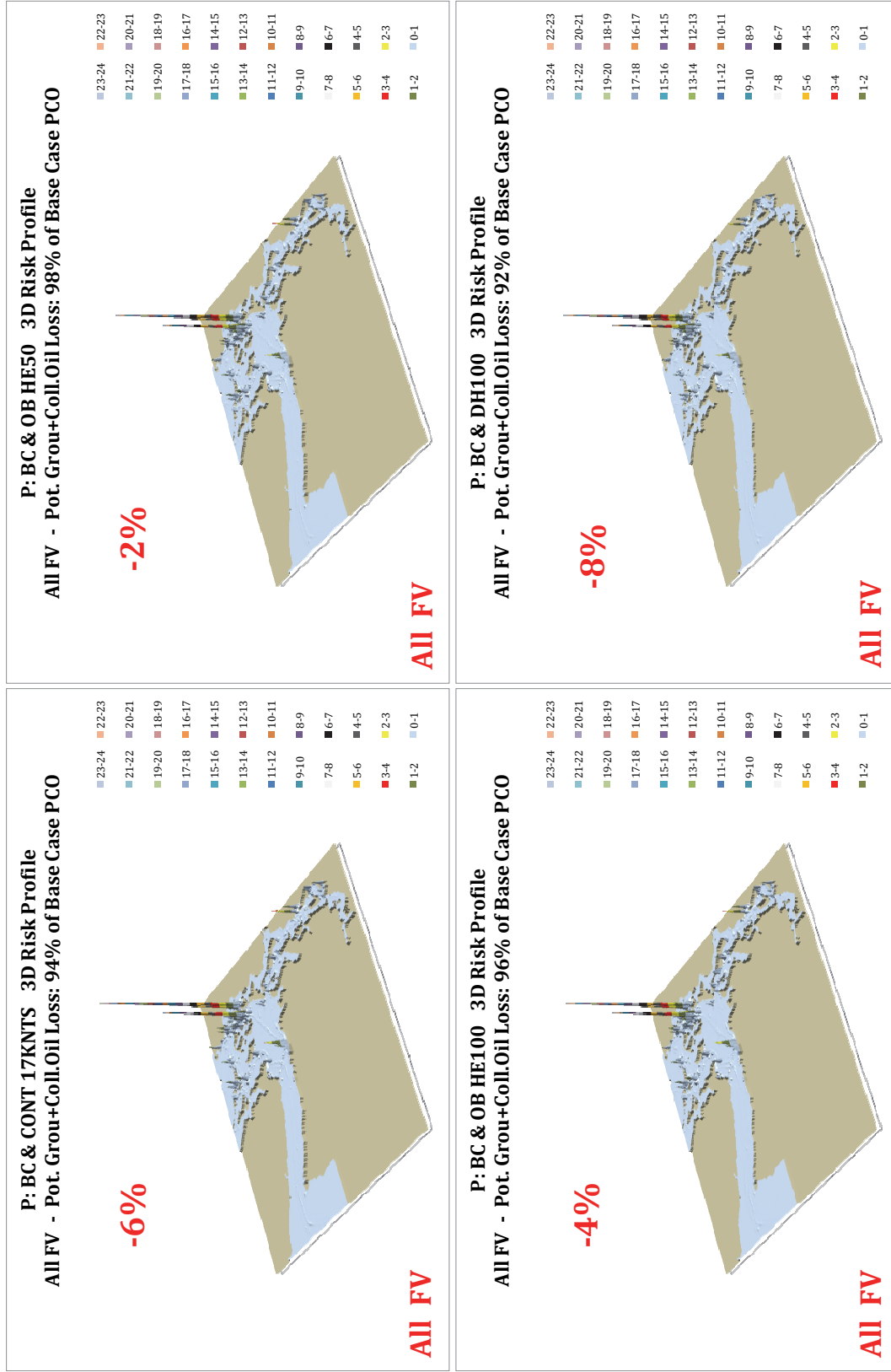

Figure 94. 3D geographic profile POTENTIAL oil outflow results of RMM's enacted on base case (P)

Q - RMM SCENARIO REFERENCE POINT				
	Vessel Time Exposure (VTE)	Oil Time Exposure (OTE)	Pot. Accident Frequency (PAF)	Pot. Oil Loss (POL)
Q - GW - 487	+13% 113%	+5% 105%	+12% 112%	+12% 112%

CASE Q - RISK MITIGATION MEASURE (RMM) ANALYSIS	
Q - GW 487 & NB	Gateway expansion scenario and no bunkering support
Q - GW 487 & NB & OH	Gateway expansion scenario and no bunkering support and traversing only Haro routes

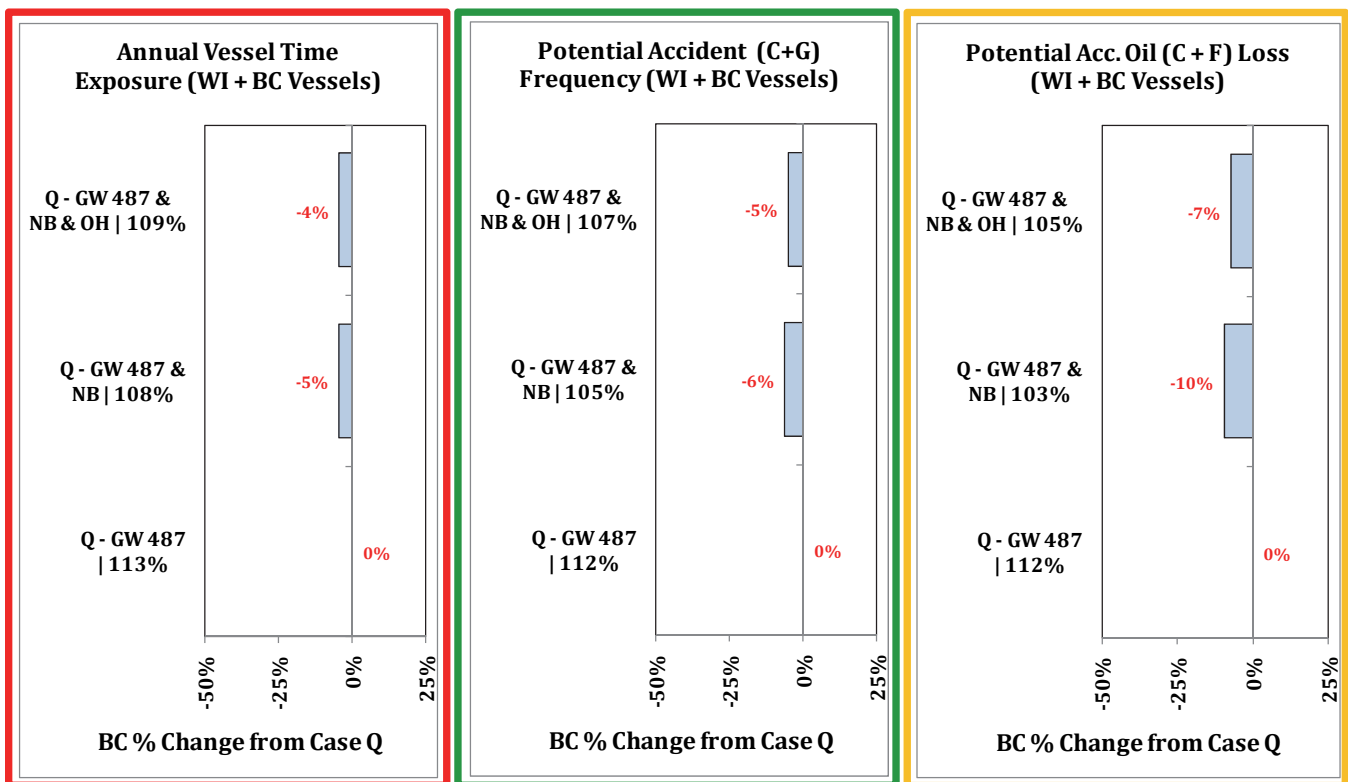

Figure 95. Summary Analysis results of RMM Scenario Analysis enacted on the Gateway What-If Scenario (Q).

By waterway zone analysis results of RMM measures enacted on Gateway What-If Scenario (Q)

Figure 96 depicts the by waterway zone comparison results for both POTENTIAL accident frequency and POTENTIAL oil loss for the RMM scenarios enacted in the Gateway What-If Scenario (Q). Absolute differences, however, are evaluated in Figure 96 as reductions from Case Q. Thus, relative waterway zone reduction factors are evaluated in Figure 96 with respect to waterway zone risk experienced under the Gateway What-If scenario (Q-GW487) in the VTRA 2010 model. The largest absolute reduction in POTENTIAL accident frequency (-1.7%) from the What-If Scenario (Q-GW487) is observed for the Q-GW487 & NB RMM scenario is observed in the Rosario Strait and Saddlebag Waterway zones. This translates for the Saddlebag waterway zone in

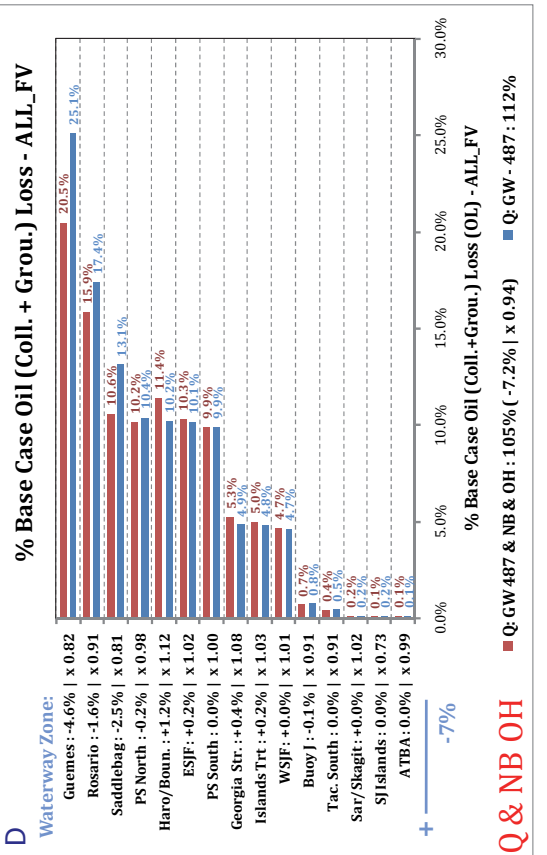
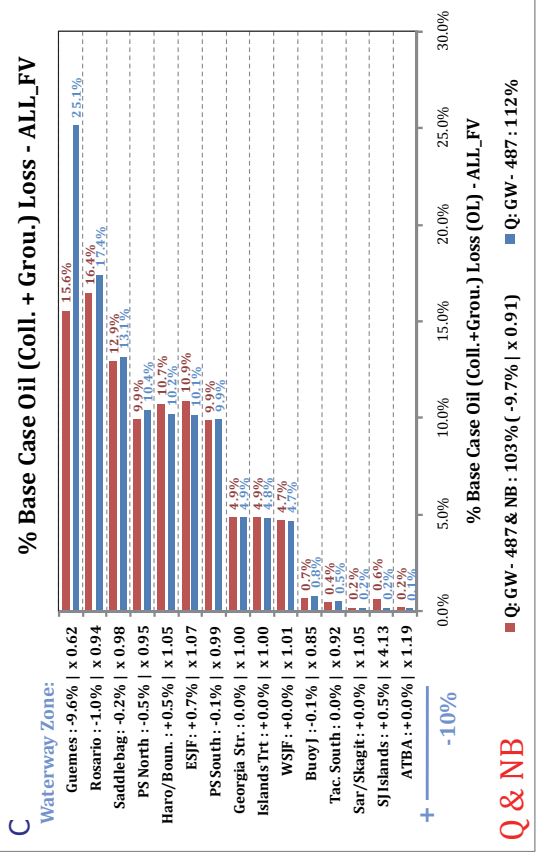
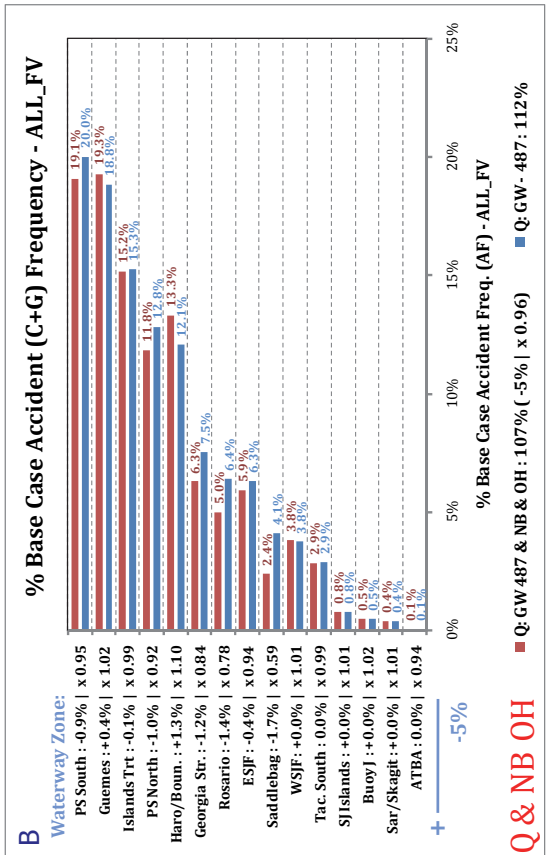
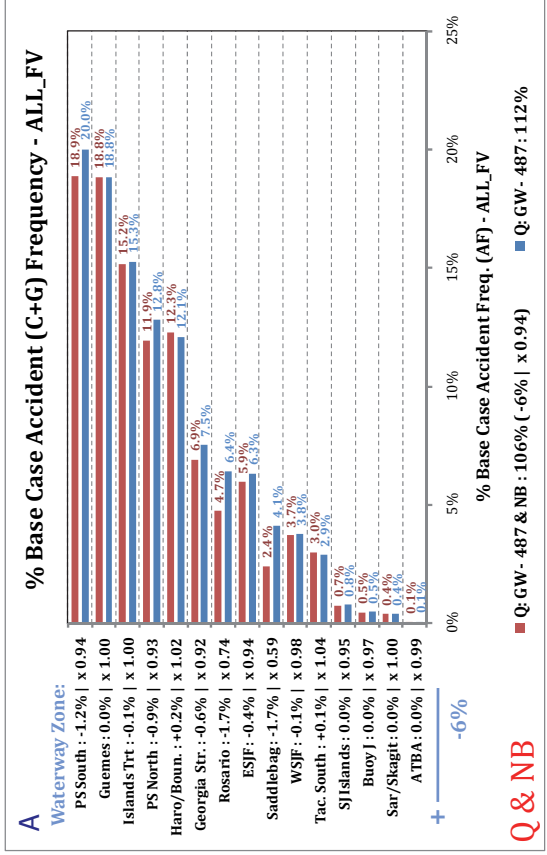

Figure 96. Waterway zone POTENTIAL accident frequency and POTENTIAL oil outflow results comparison of RMM's enacted on Gateway What-If Scenario (Q). For a detailed explanation of output format see Page 97.

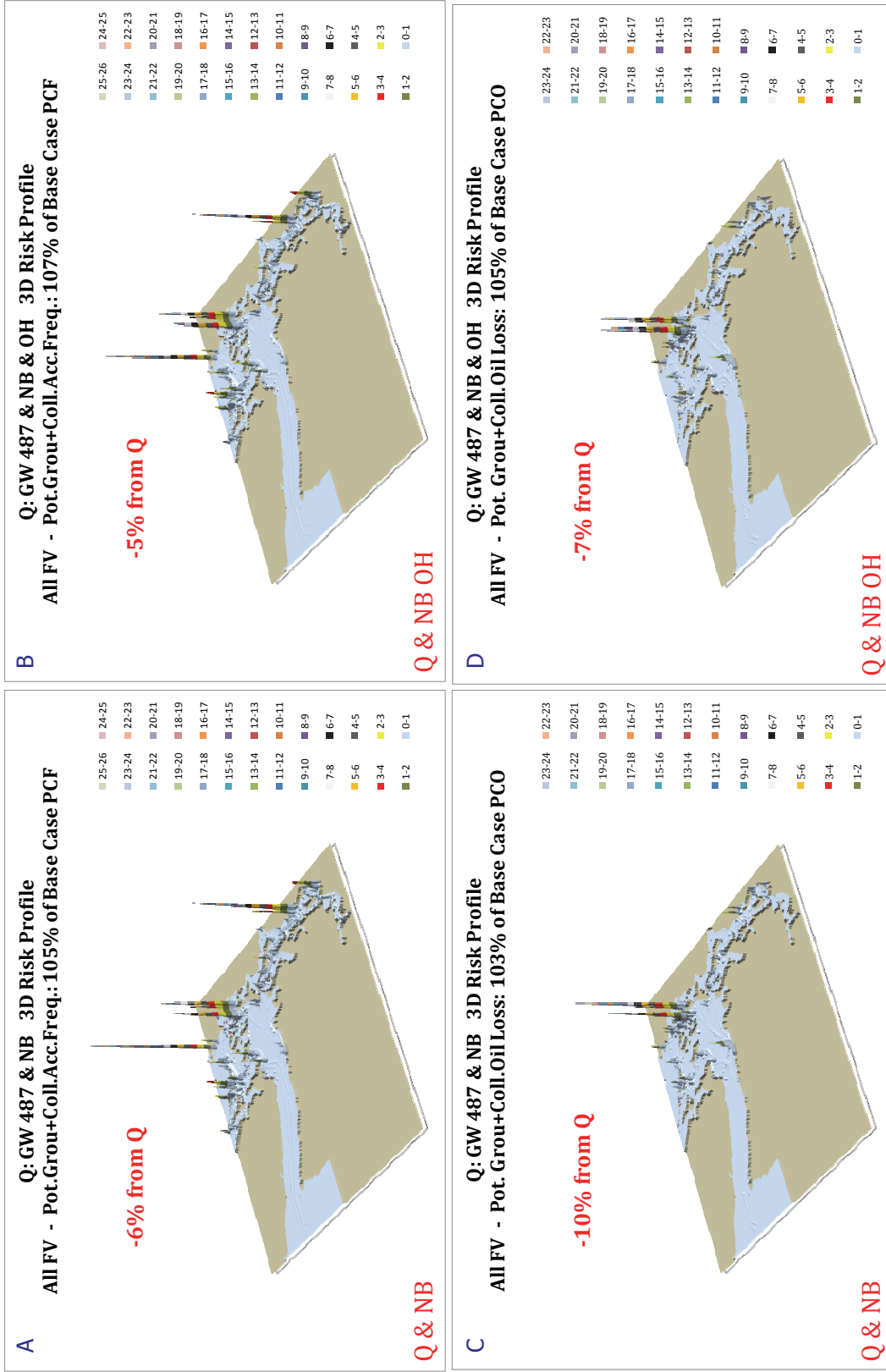

Figure 97. 3D geographic profile POTENTIAL oil outflow results of RMM's enacted on the Gateway What-If Scenario (Q)

the largest relative waterway zone reduction factor of 0.59 in terms of POTENTIAL accident frequency¹⁴. It is important to realize here that the 0.59 risk reduction factor is evaluated relative to the risk experienced in the Saddlebag waterway zone when the Gateway expansion is assumed operational within the VTRA 2010 model. However, observe from Figure 96 that the reduction in POTENTIAL accident frequency in the Saddlebag waterway zone does not translate in a reduction in POTENTIAL oil outflow. In fact, the largest waterway zone risk reduction factor in terms of POTENTIAL oil outflow of 0.62 is observed in the Guemes waterway zone, which did not experience a similar risk reduction effect in terms of POTENTIAL accident frequency. Hence, these effects are a result in a change of vessel mix and timing that different vessels see as they traverse the Saddlebag and Guemes waterway zones when oil bunkering support for Gateway is removed from the VTRA 2010 model.

Similar risk reduction effects are observed in the Q - GW487 & NB & OH RMM scenario, i.e. when removing bunkering support for Gateway and having all Gateway bulk carriers travel through Haro-Strait. Here, however, the POTENTIAL oil spill risk reduction previously experienced only in the Guemes Waterway zone now appears to be split between the Guemes and Saddlebag waterway zones. Notably, in the Q - GW487 & NB & OH RMM scenario one observes absolute increases in POTENTIAL accident frequency and POTENTIAL oil outflow of about 1% in Haro-Strait/ Boundary Pass which translate in a waterway zone relative risk increase factor of 1.10¹⁵. While the Rosario waterway zone experiences a larger waterway zone reduction factor 0.91 in the Q - GW487 & NB & OH RMM scenario (as opposed to 0.94 in the Q - GW487 & NB RMM scenario), such a larger decrease is not observed in terms of POTENTIAL accident frequency. Hence, it would appear that increases in POTENTIAL accident frequency in the Haro-Strait/Boundary Pass waterway zone under the Q - GW487 & NB & OH RMM scenario are not off-set by similar decreases in POTENTIAL accident frequency in the Rosario-Strait waterway zone in the VTRA 2010 model.

Summary of RMM Scenarios Results enacted on Combined Case T

Figure 98 depicts the summary analysis results of the POTENTIAL effectiveness of the RMM scenarios enacted on the VTRA 10 Combined What-If scenario (T – GW – KM - DP). Their absolute effectiveness is evaluated in terms of vessel time exposure, POTENTIAL accident frequency and POTENTIAL oil outflow in terms of base case percentages. Absolute differences, however, are evaluated in Figure 98 as reductions from Case T. Note, that in the three escorting scenarios ER, EH and EC no increases are observed in terms of vessel time exposure since the additional transits of escorting vessels from and to their assignment are not represented in these RMM scenario

¹⁴ Hence, in this waterway zone the RMM has a 41% risk reduction effect in POTENTIAL accident frequency.

¹⁵ Hence, by Gateway bulk carriers using only the Haro-Strait/Boundary pass routes the risk in this waterway zone increases by about 10% from the What-If Scenario Q-GW487.

FINAL REPORT: VTRA 2010

analyses. Hence, the subsequent reductions in POTENTIAL accident frequencies and POTENTIAL oil outflow ought to be interpreted as maximum POTENTIAL benefit analyses. Most notably, amongst these escorting RMM scenarios ER, EH and EC, is the 24% percent reduction in POTENTIAL oil loss in the EH RMM scenario. No doubt, this is the result of the assumption of (+1) escort for all focus vessels to mimic repositioning in the VTRA 2010 model, but also because the Case T experiences a significant waterway zone increase factor (3.75) in terms of oil time Exposure (OTE) in Haro-Strait/Boundary pass (see Figure 99) in the VTRA 2010 model.

T - RMM SCENARIO REFERENCE POINT				
	Vessel Time Exposure (VTE)	Oil Time Exposure (OTE)	Pot. Accident Frequency (PAF)	Pot. Oil Loss (POL)
T - GW - KM - DP	+25% 125%	+59% 159%	+18% 118%	+68% 168%

CASE T - RISK MITIGATION MEASURE (RMM) ANALYSIS	
T - GW - KM - DP & OW ATB	Case T with ATB's adhering to one way Rosario traffic regime
T - GW - KM - DP & EC	Case T with Cape Class bulk carrier given benefit of+ 1 escort on Haro and Rosario routes
T - GW - KM - DP & EH	Case T with all Focus Vessels given benefit of +1 escort vessel on Haro routes
T - GW - KM - DP & ER	Case T with Cape bulkers, laden Tankers, ATB's given benefit of +1 esc. on Rosario routes
T - GW - KM - DP & 6RMM	Case T with benefit OW ATB, EH, ER, P-HE50, Q-NB and P-CONT17 KNTS

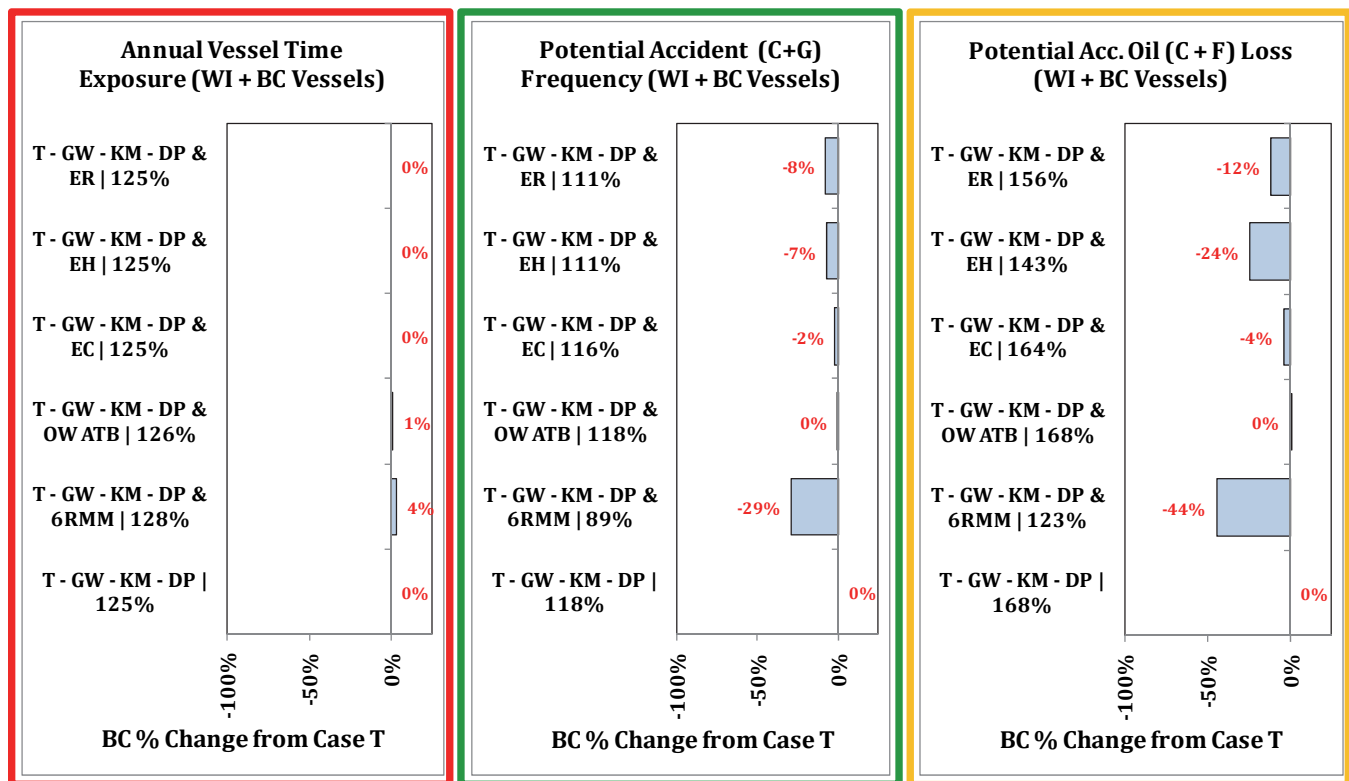

Figure 98. Summary Analysis results of RMM Scenario Analysis enacted on the Combined What-If Scenario (T).

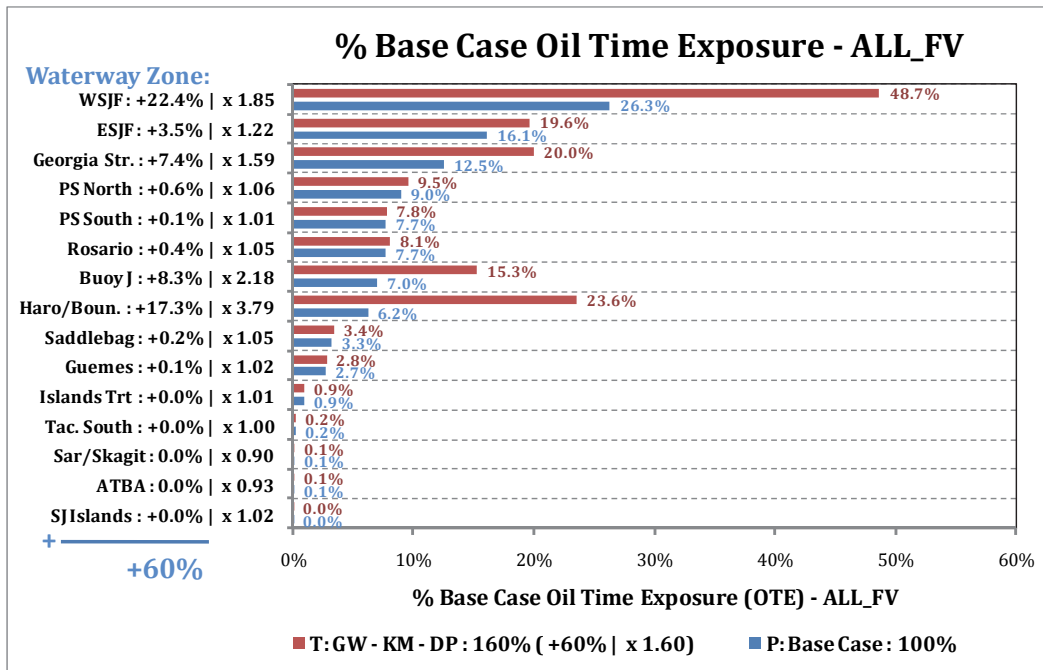

Figure 99. Waterway zone Oil Time Exposure comparison between Combined What-If Scenario (T) and the Base Case (P). For a detailed explanation of output format see Page 97.

In other words, such a reduction would not be experienced without the Trans Mountain Pipeline expansion being in effect. On the other hand, a large part of the reduction of the 12% - 4% = 8% under the ER RMM scenario (i.e. adding (+1) escort to laden tankers, chemical carriers, ATB's and Cape Class Gateway bulkers) on Rosario bound routes can be expected when the Trans Mountain Pipeline and the Gateway expansions are not in effect¹⁶. Of course, a separate analysis conducted of the ER RMM scenario enacted on the base case (P) would need to be conducted to confirm such a reduction in POTENTIAL oil loss. Note that while the T-GW-KM-DP EH RMM scenario is more effective in terms of reduction of POTENTIAL oil loss compared to the T-GW-KM-DP ER RMM scenario, the reverse is observed for the reduction in POTENTIAL accident frequency.

Observe from Figure 98 that the RMM scenario of ATB's also obeying the one way zone regime does not appear to be an effective RMM measure in the VTRA 2010 model, neither in terms of POTENTIAL oil loss nor in terms of POTENTIAL accident frequency. In fact, a (+1%) increase in vessel time exposure is observed in the T-GW-KM-DP & OW ATB RMM scenario as a result of additional delays as an effect of adding ATB's to the Rosario one way zone regime in the VTRA 2010 model.

¹⁶ We are subtracting the 4% benefit evaluated for the EC escorting scenario to get to 8%.

Finally, it would be interesting to conclude if the six RMM's in the T-GW-KM-DP & 6RMM scenario have an overall additive effect. Since absolute effectiveness of the RMM scenarios listed in Table 12 are all evaluated in terms of base case percentages, we can combine the overall benefit percentage changes evaluated on the Base Case (P) RMM, Gateway (Q) RMM and Combined (T) RMM scenario's. In terms of the benefit of absolute POTENTIAL accident frequency reduction we have for P-BC & 17knts (-4%), P - BC & HE50 (-8%), Q - GW487 & NB (-1%), T-GW-KM-DP & ATB (-0%), T - GW-KM-DP EH (-7%) and finally T - GW-KM-DP EH (-8%), summing to (-27%) which is close to the evaluated reduction (-29%) evaluated for the T-GW-KM-DP & 6RMM scenario. In terms of the benefit of absolute POTENTIAL oil loss reduction we have for P-BC & 17knts (-6%), P - BC & HE50 (-2%), Q - GW487 & NB (-10%), T-GW-KM-DP & ATB (-0%), T - GW-KM-DP EH (-24%) and finally T - GW-KM-DP EH (-14%), summing to a (-55%) which is a greater reduction than the evaluated reduction (-44%) evaluated for the T-GW-KM-DP & 6RMM scenario. The latter is indicative of our position that once risk reduction in a particular waterway has been addressed that it will become progressively more difficult to reduce risk even further in that waterway zone. Note, that in the T-GW-KM-DP & 6RMM scenario analysis the P - BC & DH100 was not included which resulted in a POTENTIAL oil outflow reduction of (-8%). Hence, if enacted in addition on Case T next to the other 6RMM's one could expect an additional 8% reduction. Of course, once again, this would have to be confirmed by evaluating the benefit of adding the DH100 RMM to the T-GW-KM-DP & 6RMM scenario.

By waterway zone analysis results of RMM measures enacted on Combined What-If Scenario (T)

Figure 100 and Figure 101 depict the by waterway zone comparison results for both POTENTIAL accident frequency and POTENTIAL oil loss for the RMM scenarios enacted on the Combined What-If Scenario (T - GW - KM - DP). Absolute differences, however, are evaluated in Figure 96 as reductions from Scenario T. Relative waterway zone reduction factors are evaluated in Figure 100 and Figure 101 relative to waterway zone risk experienced under the Combined What-If scenario (T - GW - KM - DP) in the VTRA 2010 model.

As a first observation, observe from Figure 100 and Figure 101 that the T-GW-KM-DP & 6RMM scenario results in risk reduction across virtually all fifteen waterway zones, whereas the escorting RMM scenarios ER and EH alternate their benefit primarily in the waterway zones Rosario Strait and Haro-Strait/Boundary Pass. From the legend in Figure 100 it follows that the POTENTIAL accident frequency (89%) in the T-GW-KM-DP & 6RMM scenario is evaluated as less than the POTENTIAL accident frequency (100%) of the Base Case (P)!

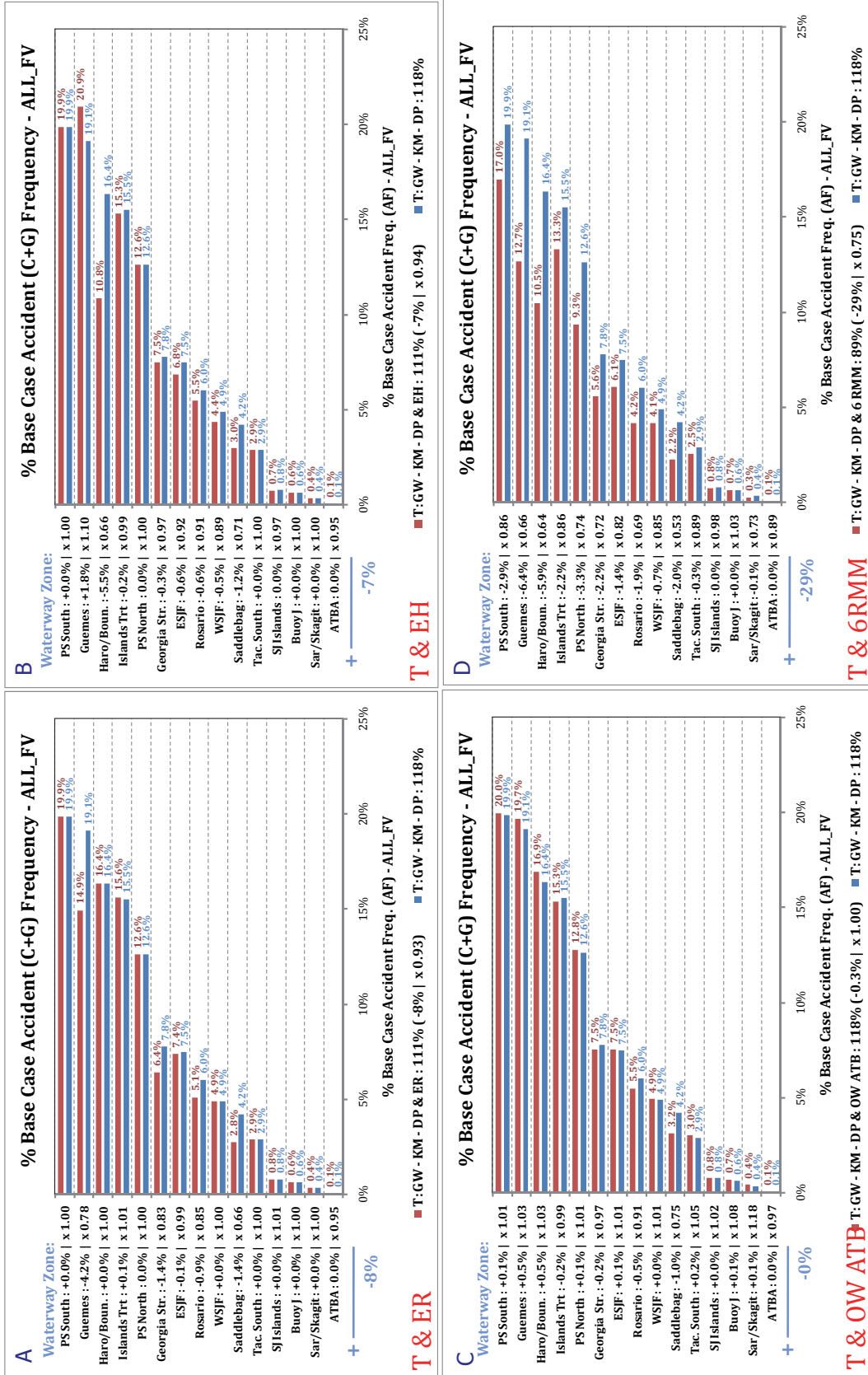

Figure 100. Waterway zone POTENTIAL accident frequency results comparison of RMM's enacted on Gateway What-If Scenario (Q). For a detailed explanation of output format see Page 97.

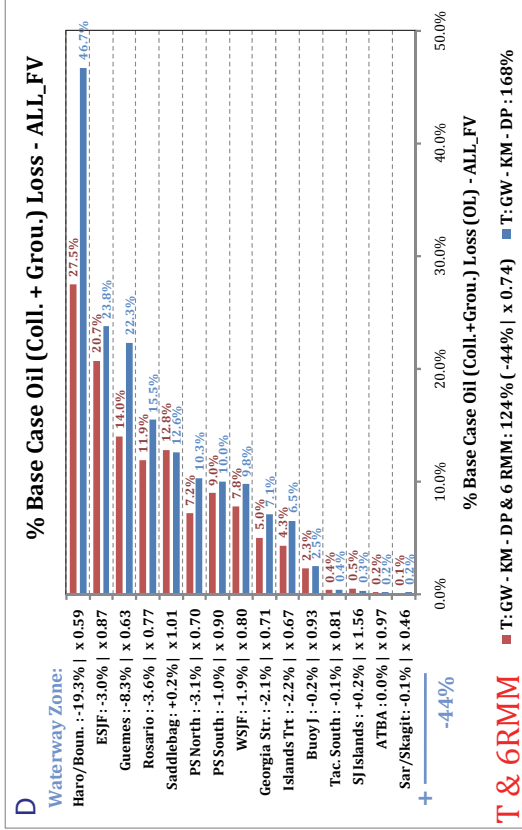
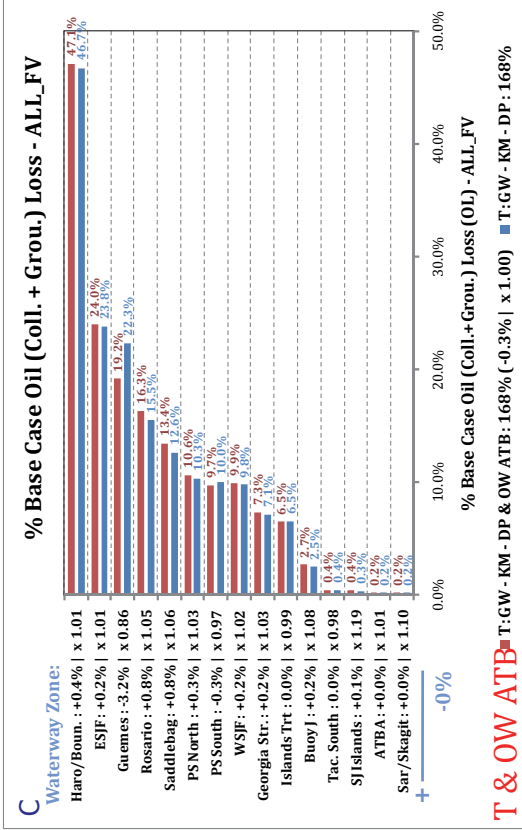
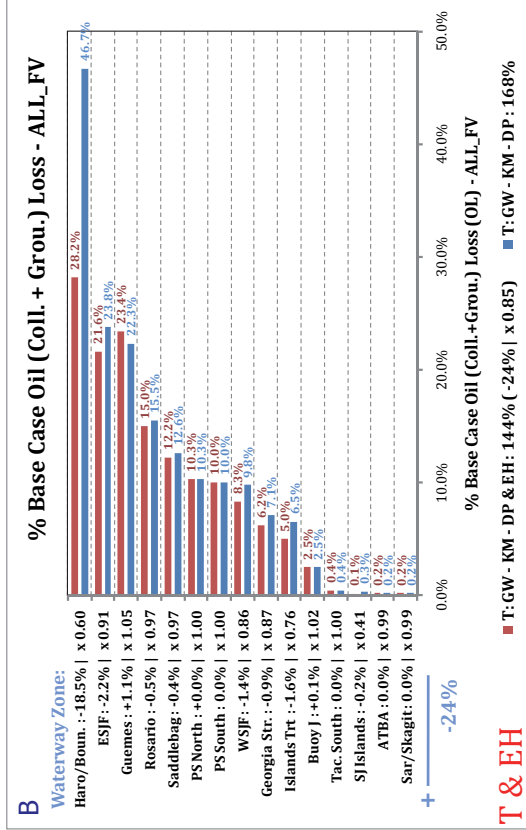
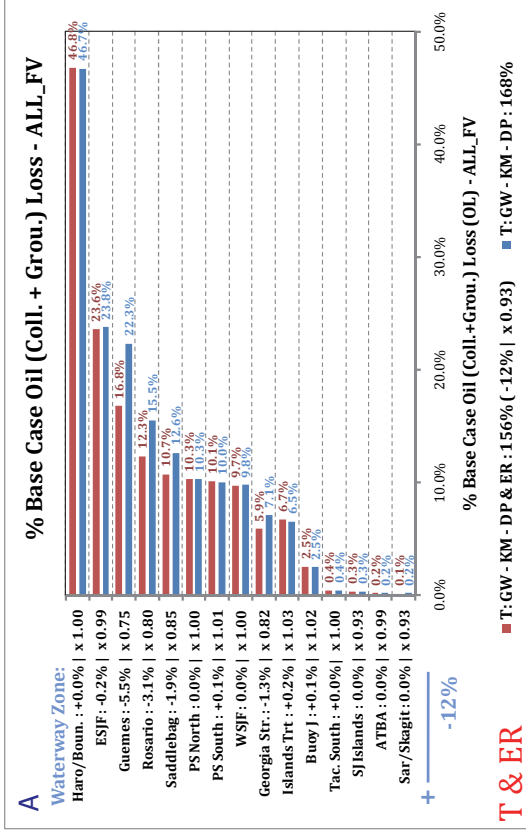

Figure 101. Waterway zone POTENTIAL oil outflow results comparison of RMM's enacted on Gateway What-If Scenario (Q). For a detailed explanation of output format see Page 97.

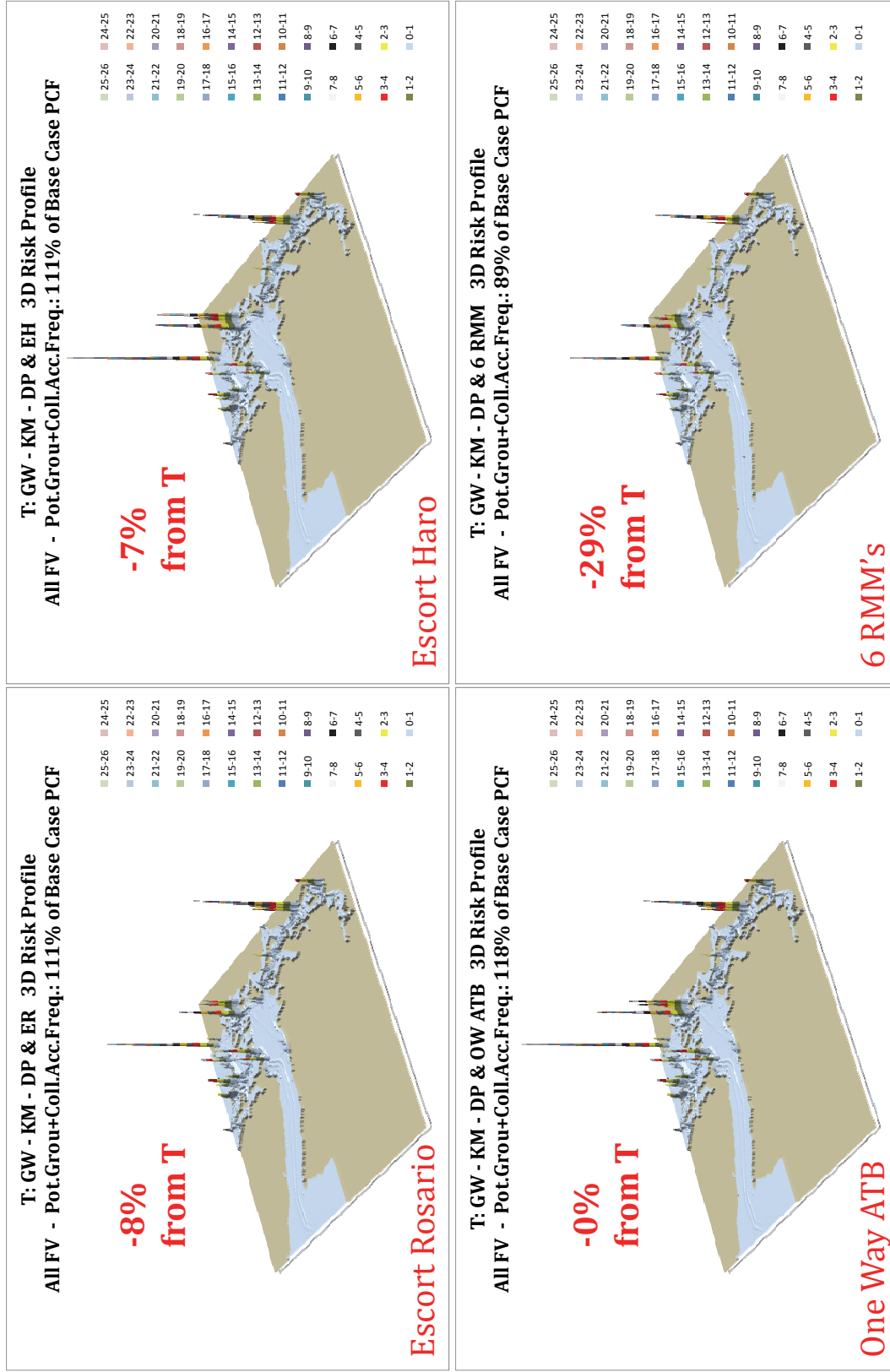

Figure 102. 3D geographic profile POTENTIAL accident frequency results of RMM's enacted on the Combined What-If Scenario (T)

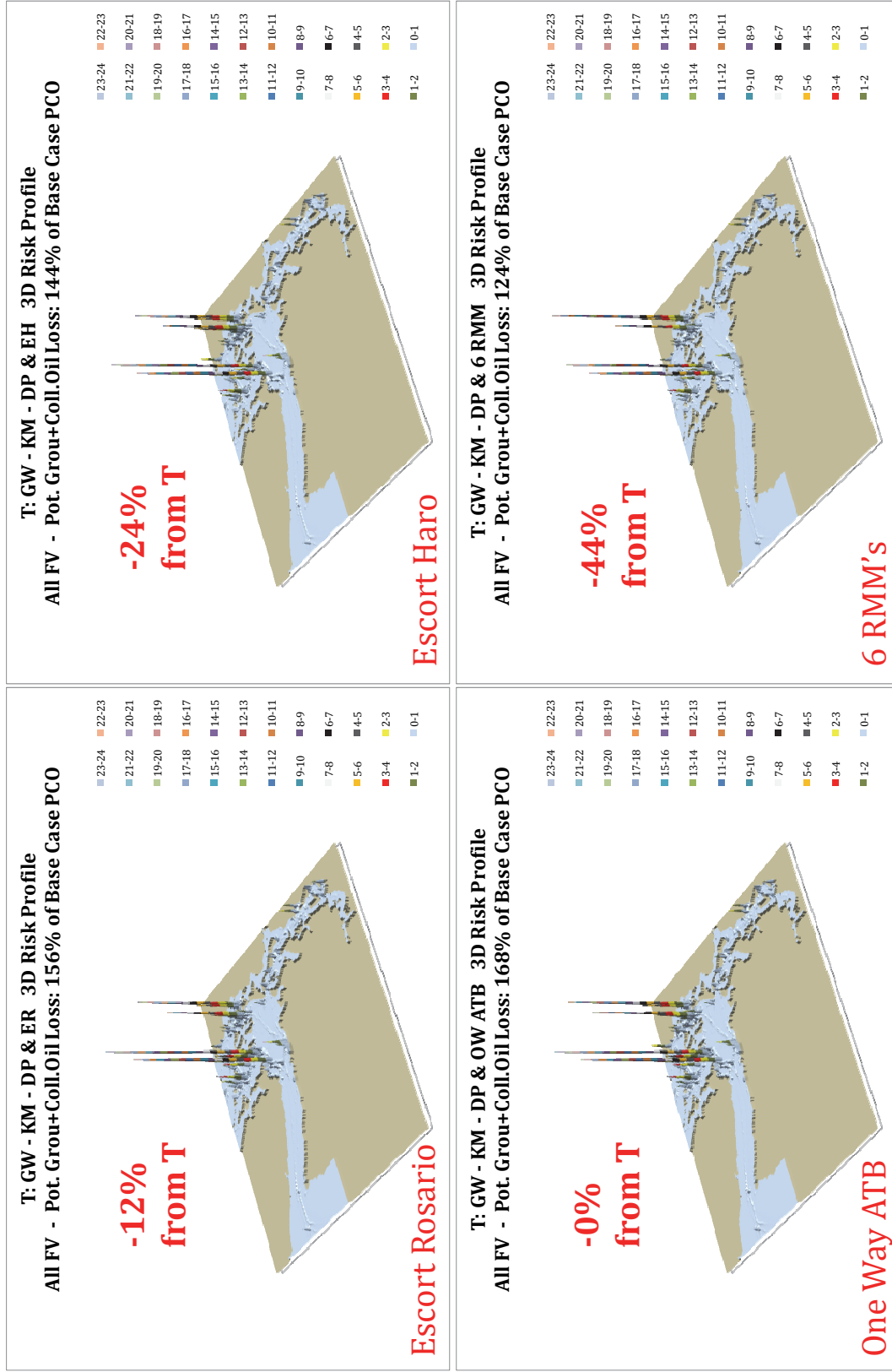

Figure 103. 3D geographic profile POTENTIAL oil outflow results of RMM's enacted on the Combined What-If Scenario (Q)

For the ER RMM Scenario one observes an absolute risk reduction of 1% in terms of POTENTIAL accident frequency and 3.1% in terms of POTENTIAL oil outflow in the Rosario Strait waterway zone. These translate in waterway zone relative risk reduction factors of 0.85 in POTENTIAL accident frequency and 0.80 in POTENTIAL oil loss in the Rosario Strait waterway zone. Most notably, one observes a 0.66 relative risk reduction factor in POTENTIAL accident frequency in the Saddlebag waterway zone and 0.75 in terms of POTENTIAL oil loss¹⁷. We attribute this to the additional escorting of laden ATB's which are currently not escorted. The difference in benefit between the Rosario Strait and Saddle bag waterway zones we attribute to laden tankers already being assigned an escort vessel. Similar relative waterway zone risk reduction factors are observed in the Haro-Strait/Boundary Pass waterway zone under the EH RMM scenario (0.66 in terms of POTENTIAL accident frequency and 0.64 in terms of POTENTIAL oil outflow). These translate into an absolute (-5.5%) reduction in POTENTIAL accident frequency and an (-18.5%) reduction in POTENTIAL oil loss in the Haro-Strait/Boundary Pass waterway zone.

¹⁷ Hence, this RMM results in a 34% and 25% risk reduction in this waterway zone in POTENTIAL accident frequency and POTENTIAL oil outflow respectively.

THIS PAGE IS LEFT
INTENTIONALLY BLANK

9. BENCH MARK/SENSITIVITY SCENARIOS

Historical arrival data was obtained through the Marine Exchange Puget Sound (MXPS) regarding arrivals of tank focus vessels and cargo focus vessels. Tanker arrival data was obtained for the years 1998-2012 by the three major refinery destinations within the VTRA study area, i.e. Cherry Point, Anacortes and Ferndale. Cargo vessel Automatic Identification System (AIS) crossing line count data was obtained from 2008 – 2012 for crossing lines at the entrance of the West Strait of Juan de Fuca, the entrance of the Puget Sound and the entrance of Georgia-Strait (see Figure 104 for a depiction and general location of these crossing lines). Prior to 2008, AIS was not available or AIS was not considered a reliable data source yet.

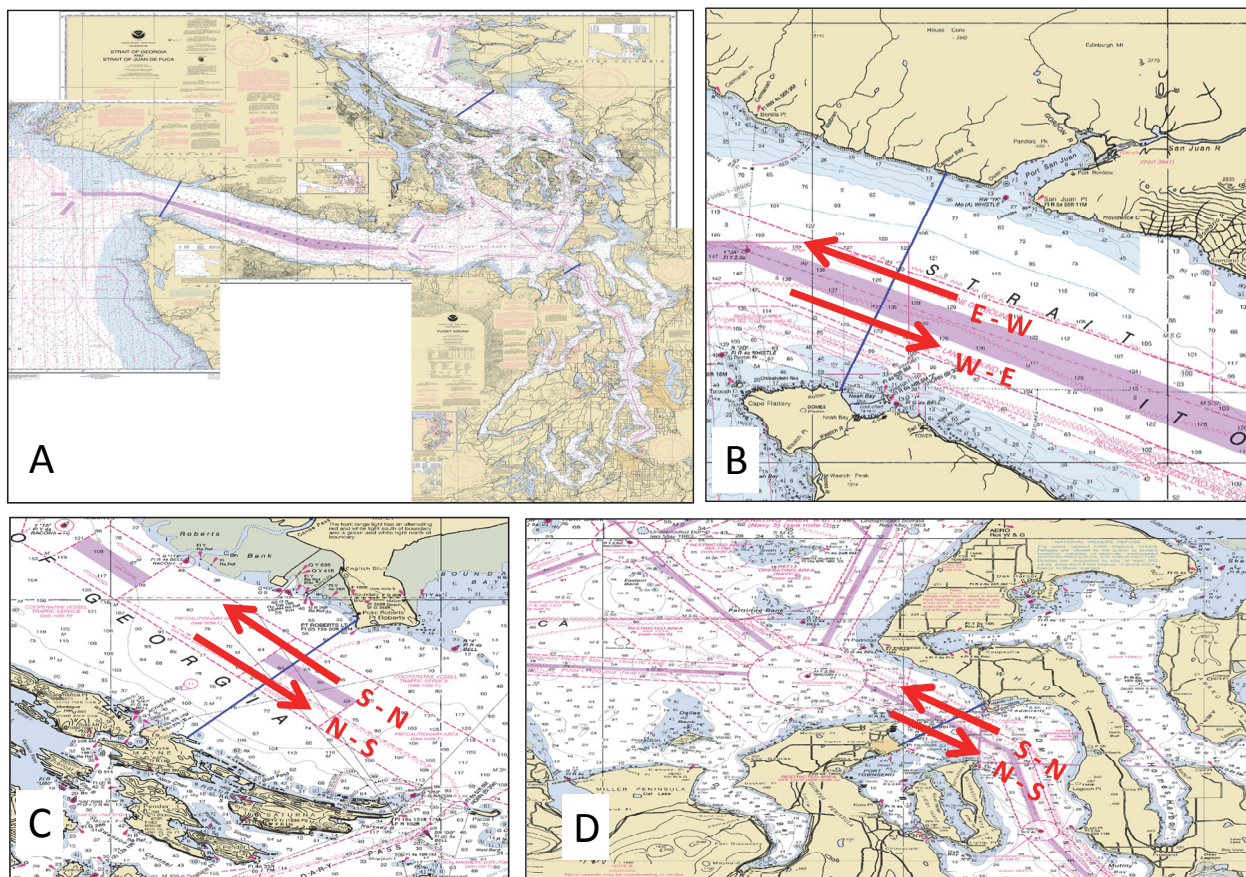

Figure 104. A: Overview of three AIS crossing definitions; B: Close-up view of crossing line at the West Strait of Juan de Fuca Entrance; C: Close-up view of crossing line at the George Strait entrance; D: Close-up view of the crossing line at the Puget Sound entrance.

An analysis was conducted on both datasets (described in more detail below) and a high and low year was selected for both data sets. High years were used to define high traffic benchmarking/sensitivity scenarios, whereas low years were used to define low traffic benchmarking/sensitivity

analyses scenarios by adding/canceling vessel transits to/from the 2010 Base Case (P) and the combined What-If Scenario (T).

The purpose of the benchmarking/sensitivity analysis is three-fold. First, to provide a robustness analysis of the VTRA 2010 Base Case (P) and Combined What-If Scenario (T) analyses results in light of historical increases or decreases in traffic. Second, the high-low scenario analyses conducted on the Base Case (P) serve as a benchmark to compare (1) delta changes in VTRA 2010 analyzed risk levels for the various What-If and RMM Scenarios against (2) delta changes in VTRA 2010 analyzed risk levels at historical traffic levels. Third, it provides context regarding changes occasioning in the background that in conjunction with proposed What-If scenario expansions further inform the potential need for risk management actions.

Modeling the High-Low levels for Tank Focus Vessels

Table 13 provides the tanker arrival count data obtained from the MXPS. Figure 105 depicts a historical trend analysis by refinery destination for the row totals by destination in Table 13. One observes from Figure 105 that tank focus vessel arrivals for the Ferndale destination have remained relatively constant whereas on average an increase of about 5 tank focus vessel arrivals per year have been observed for the Anacortes destination and on average an increase of about 10 tank focus vessels arrivals per year for the Cherry Point destination.

The base case year (2010), the selected high year for tanker arrivals (2007), and the selected low year (1998) are indicated in Figure 105. The selections of the high-low years coincide with the high (730) and low (541) years observed for distinct tank focus vessels arrivals to the Puget Sound listed in Table 13. The modeling culmination of adding high tank focus vessel levels to the VTRA 2010 Base Case (P) and the combined What-If scenario (T) in terms of vessel time exposure is depicted in the top 2 panels of Figure 106. From Figure 106 one observes that the addition of 142 tankers leads to a delta change of (+2%) in terms of vessel time exposure relative to the Base case (P) total focus vessel time exposure.

Modeling the High-Low Levels for Cargo Focus Vessels

Due to a larger number of destinations for cargo focus vessels the selection of a high-low year is more challenging. Moreover, traditional MXPS data collection efforts focus on US arrivals, not Canadian bound cargo focus vessels. To account for Canadian bound cargo focus vessel traffic AIS crossing count data was requested for the longest period that yearly AIS data was considered operationally reliable. This period was deemed to be 2008-2012. The data obtained from the MXPS is provided in Figure 107. Figure 107 also contains a rough schematic of the VTRA study waterway with its main origins and destinations identified in Figure 107 as Buoy J (1), Puget Sound (2) and Georgia Strait (3).

FINAL REPORT: VTRA 2010

Table 13. Arrival Counts of Tankers for the three major refinery destinations in the VTRA 2010 study area

ARRIVALS INTO PUGET SOUND (DISTINCT ARRIVALS, NO SHIFTS)															
TOTAL TANK SECTOR	1998	1999	2000	2001	2002	2003	2004	2005	2006	2007	2008	2009	2010	2011	2012
PETROL TANKER	487	497	543	487	493	494	451	455	471	517	476	505	427	462	441
CHEM TANKER	50	60	46	47	40	24	16	14	30	34	23	17	15	16	12
PETRO/CHEM	537	557	589	534	533	518	467	469	501	551	499	522	442	478	453
ITB/ATB	4	9	32	47	65	130	167	145	183	179	179	172	148	130	142
TOTAL TANK SECTOR	541	566	621	581	598	648	634	614	684	730	678	694	590	608	595

ARRIVALS TO EACH OF THE NORTH SOUND REFINERY AREAS															
FERNDALE REFINERY	1998	1999	2000	2001	2002	2003	2004	2005	2006	2007	2008	2009	2010	2011	2012
PETROL TANKER	118	136	136	99	88	86	69	113	92	92	103	108	86	88	81
CHEM TANKER	0	0	0	0	2	0	0	0	0	0	4	2	3	2	1
PETRO/CHEM	118	136	136	99	90	86	69	113	92	92	107	110	89	90	82
ITB/ATB	0	0	0	0	0	4	12	16	17	19	15	24	26	17	21
TOTAL	118	136	136	99	90	90	81	129	109	111	122	134	115	107	103

CHERRY POINT REFINERY	1998	1999	2000	2001	2002	2003	2004	2005	2006	2007	2008	2009	2010	2011	2012
PETROL TANKER	189	189	224	167	164	213	116	196	206	243	266	205	203	197	163
CHEM TANKER	0	1	13	4	1	1	10	15	12	36	28	70	70	59	72
PETRO/CHEM	189	190	237	171	165	214	126	211	218	279	294	275	273	256	235
ITB/ATB	4	15	33	54	49	88	65	89	134	119	82	63	56	41	64
TOTAL	193	205	270	225	214	302	191	300	352	398	376	338	329	297	299

ANACORTES REFINERIES	1998	1999	2000	2001	2002	2003	2004	2005	2006	2007	2008	2009	2010	2011	2012
PETROL TANKER	183	250	270	250	253	258	143	240	217	240	172	160	121	178	195
CHEM TANKER			1	1	24	13	19	16	22	24	29	39	33	56	42
PETRO/CHEM	183	250	271	251	277	271	162	256	239	264	201	199	154	234	237
ITB/ATB	1	5	4	10	18	50	39	54	40	55	93	96	88	84	85
TOTAL	184	255	275	261	295	321	201	310	279	319	294	295	242	318	322

SUM OF THREE AREAS	1998	1999	2000	2001	2002	2003	2004	2005	2006	2007	2008	2009	2010	2011	2012
	495	596	681	585	599	713	473	739	740	828	792	767	686	722	724

Next, we introduce the variable x_{12} to represent the annual cargo focus vessel traffic flow from Buoy J to the Puget Sound and x_{13} to represent the annual cargo focus vessel traffic flow from Buoy J to the Georgia Strait, etc. In other words, the variable x_{ij} represents the annual cargo focus vessel flow from origin (i) to destination (j). The sum of the variables x_{12} and x_{13} represents the total annual in-flow of cargo focus vessels to the VTRA study area at Buoy J. Considering the destinations (2) and (3) as “closed” it follows that traffic that arrives at Buoy J, must leave at Buoy J¹⁸. In other words:

$$X_{12} + X_{13} = X_{31} + X_{21}.$$

¹⁸ We are assuming here that cargo focus vessel traffic that travels from Buoy J to the Georgia Strait does not leave through the Northern Passage.

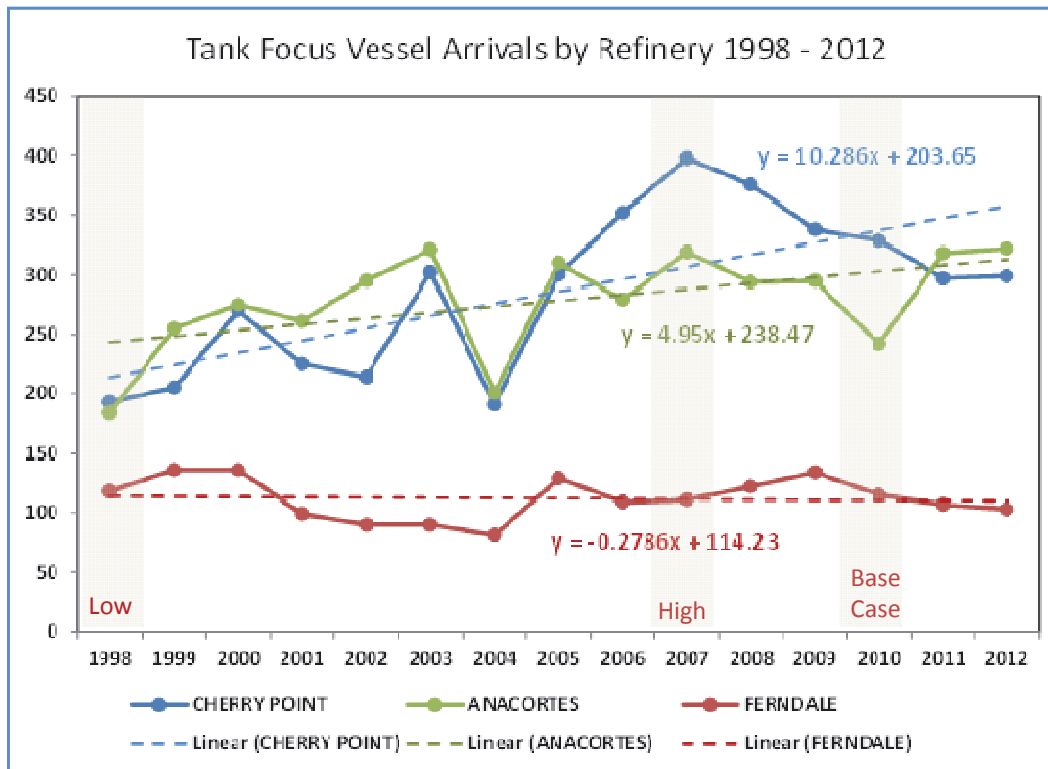

TANKER CALL NUMBER HIGH-LOW ANALYSIS FROM 1998-2012

	LOW - YEAR: - #	2010	HIGH - YEAR: + #
CHERRY POINT	193 - 1998 : -136	329	398 - 2007 : +69
ANACORTES	184 - 1998 : -58	242	319 - 2007 : +77
FERNDALE	118 - 1998 : 3	115	111 - 2007 : -4
Total Change Tank FV	-191		+142

Figure 105. High-Low traffic year analysis conducted on 1998-2012 MXPS refinery arrival data in Table 13

This is called a traffic flow balance equation. Following similar reasoning a set of balance equations can be formulated (all indicated in Figure 107) from which values for the variables x_{ij} can be solved. The solution of these equations for each year is depicted in Figure 108. Observe from the solution that on balance the traffic flow from Buoy J to Puget Sound equals the traffic flow from Puget Sound to Buoy J, etc. This solution, however, does not preclude a particular vessel to travel from Buoy J to Puget Sound, next from Puget Sound to Georgia Strait and from Georgia Strait to Buoy J, or any other traffic pattern. That particular vessel would simply be part of different traffic flows. What this solution does mean, however, is that on average cargo vessel traffic flow from Buoy J to Puget Sound equals the cargo focus vessel traffic flow from the Puget Sound to Buoy J. The same applies to other paired origins and destinations.

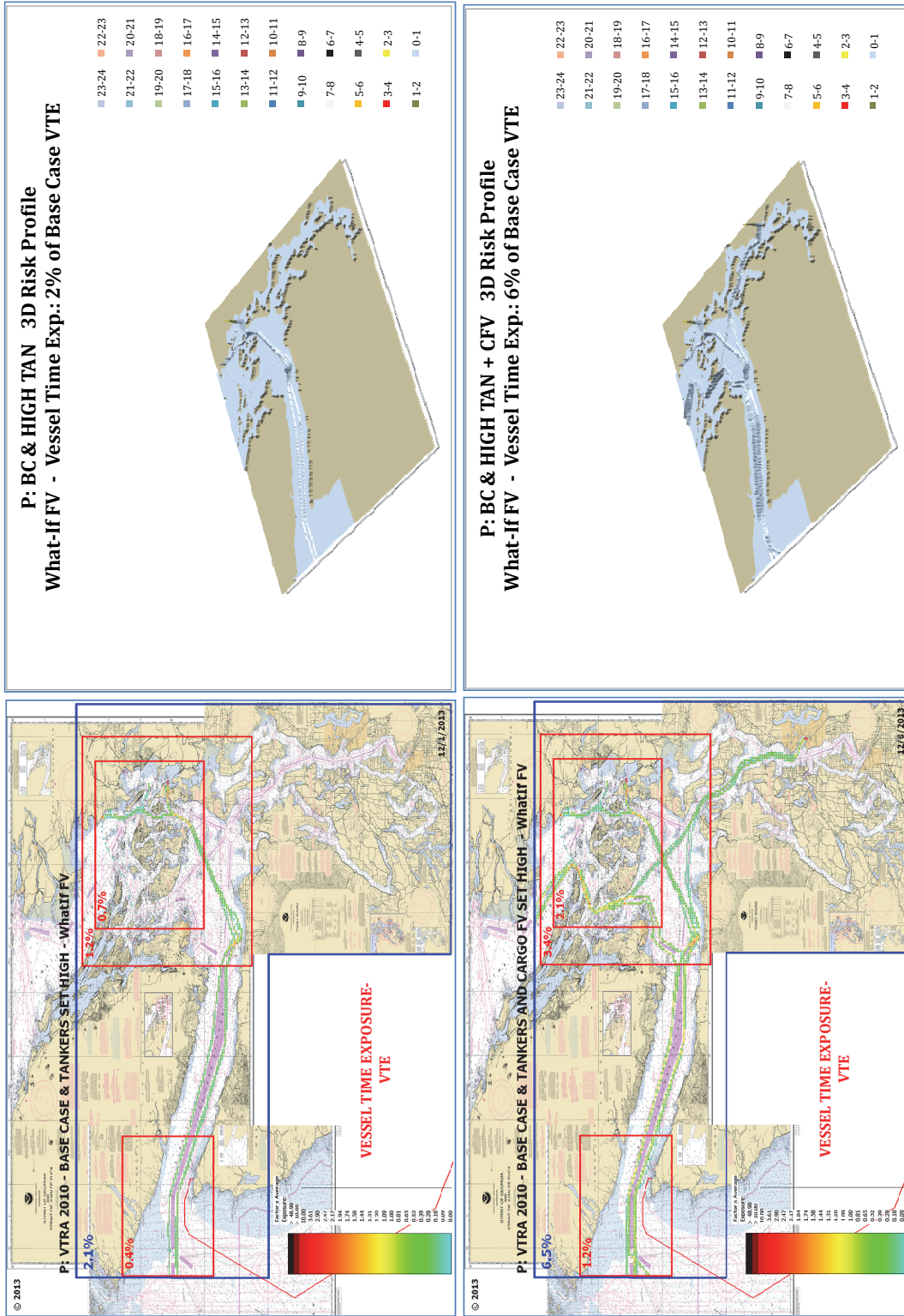

Figure 106. 2D and 3D Geographic profiles of added tanker and cargo focus vessel traffic in benchmark/sensitivity analyses enacted on the VTRA 2010 base case (P) and the combined What-If Scenario (T).

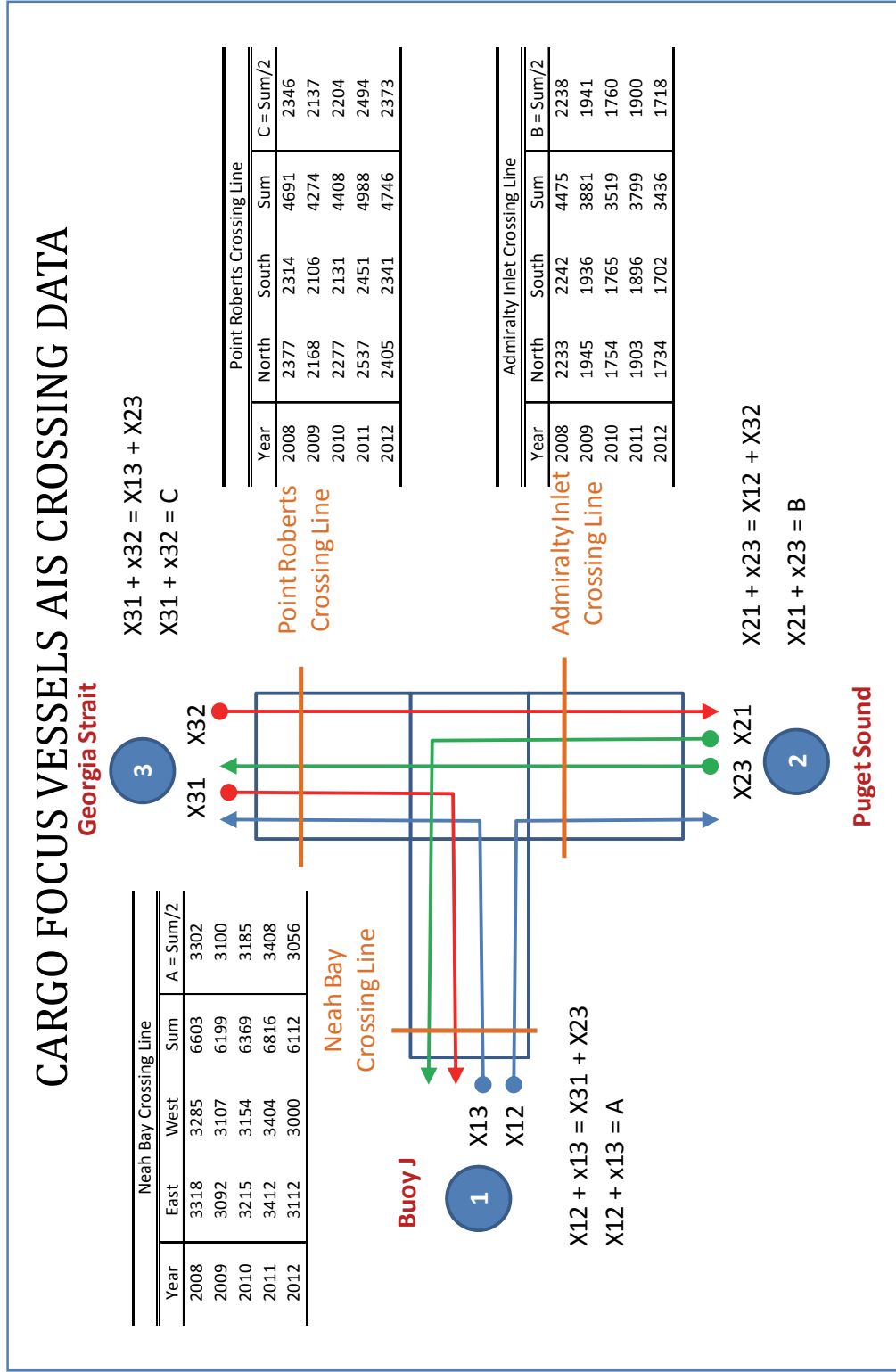

Figure 107. AIS count data from 2008-2012 for Neah Bay, Admiralty Inlet and Point Roberts crossing lines depicted in Figure 104.

CARGO FOCUS VESSELS AIS CROSSING LINE ANALYSIS

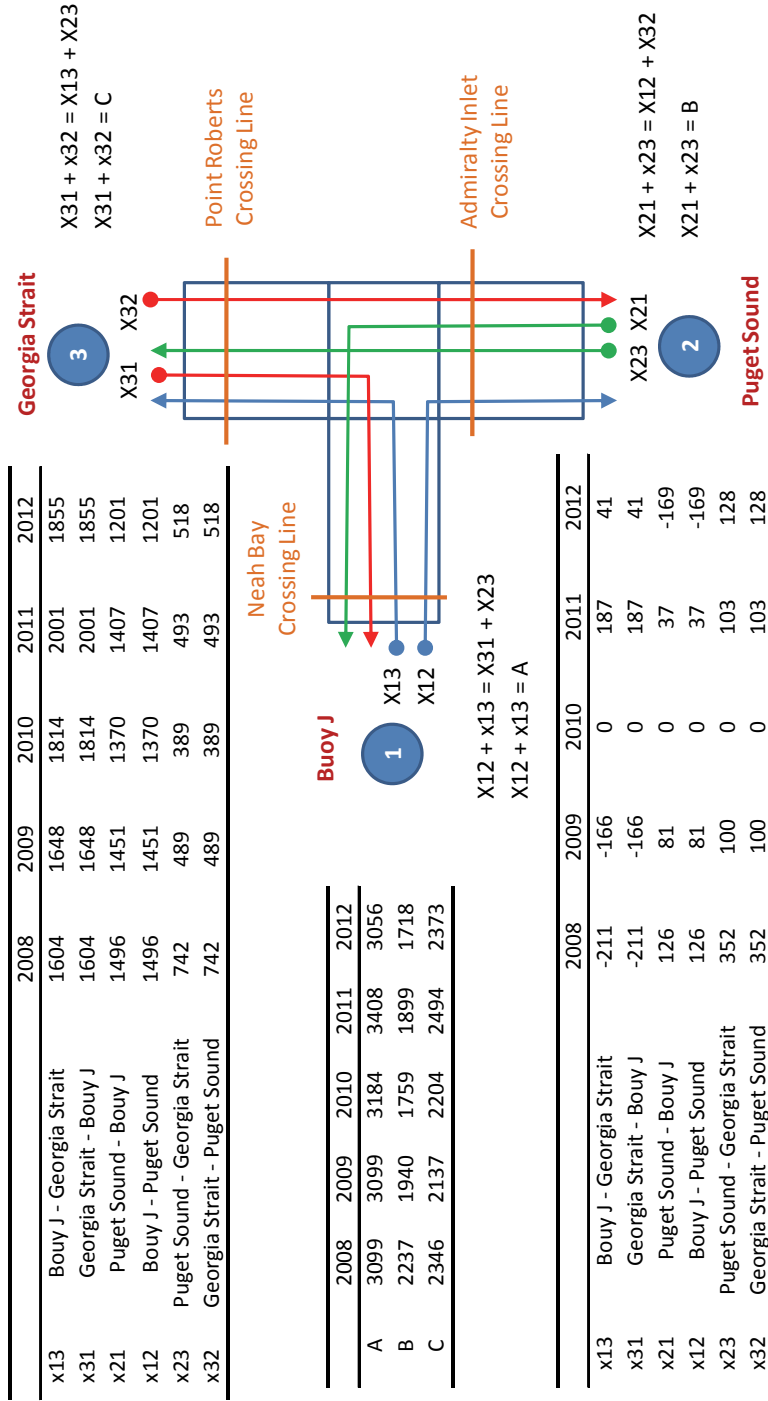

Figure 108. Traffic flow analysis based on 2008-2012 AIS crossing line count data provided in Figure 107

FINAL REPORT: VTRA 2010

In Figure 109 a 5-year trend analysis is presented of the cargo focus vessel traffic flow solution provided in Figure 108 for the traffic flows:

1. Buoy J to Puget Sound and vice versa
2. Puget Sound to Georgia Strait and vice versa
3. Buoy J to Georgia Strait and vice versa

Observe from Figure 109 that the analysis results suggest that cargo focus vessel traffic between Buoy J and Puget Sound has decreased on average over the period from 2008-2012 by about 64 vessels a year, cargo focus vessel traffic between Georgia Strait and Buoy J has decreased on average by about 44 vessels year, but cargo focus vessel traffic between Buoy J and Georgia Strait has increased by about 86 vessels per year.

The selected high and low year for cargo focus vessels indicated in Figure 109 coincide with the high and low year counts of cargo focus vessels at the Neah Bay crossing line (see Figure 107). Following the selection of the high-low years for cargo focus vessels, cargo focus vessel crossing line counts were separated into bulk carrier, container and other cargo focus vessel counts using their percentage contribution to the 2010 cargo focus vessel class. These contributions were evaluated utilizing the VTRA 2010 model crossing count algorithm at the three crossing lines depicted in Figure 104. Following separation into bulk carrier, container and cargo focus vessel crossing line counts for 2008 – 2012 yearly separate balance equations were solved resulting in the high-low counts by bulk carriers, container ships and cargo focus vessels listed in Figure 109.

The modeling culmination of adding high cargo focus vessel traffic levels to the VTRA 2010 base case (P) and the combined What-If scenario (T), in addition to 142 added tank focus vessel, is depicted in the bottom 2 panels of Figure 106. From Figure 106 one observes that the addition of 287 cargo focus vessels results in a delta change of about $7\% - 2\% = +5\%$ in terms of vessel time exposure relative to the base case (P) total focus vessel time exposure.

Modeling added variability in arrivals of what-if focus vessels

Arrivals of What-If focus vessels were modeled in the VTRA 2010 analyses as equidistant in time as indicated in the top part of Figure 110 ensuring a specified annual number of additional arrivals per year. The Steering Committee showed an interest in analyzing the effect of this equidistant arrival assumption of the What-If focus vessel arrival pattern. To that end, a sensitivity scenario was constructed by modifying the combined What-If scenario (T) with added random variability of What-If focus vessel arrivals as depicted in the bottom part of Figure 110. Observe from the bottom part of Figure 110 that in the added arrival variability scenario What-If focus vessels arrive randomly within equidistant time intervals. This arrival pattern still assures the arrival of a specified number of arrivals annually.

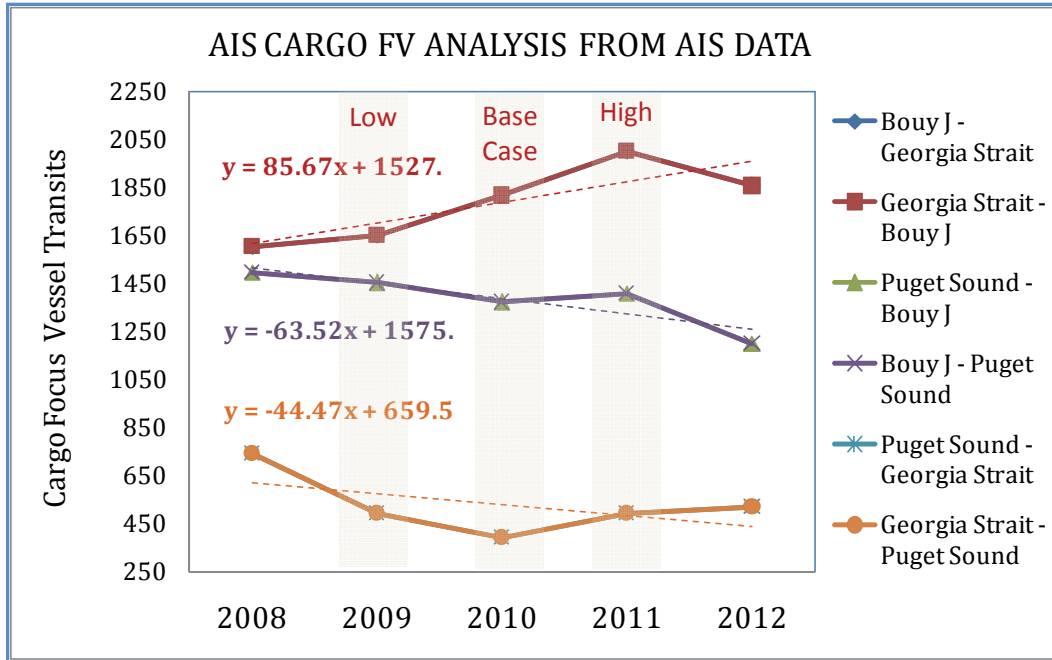

BULK TRANSIT NUMBER HIGH-LOW ANALYSIS FROM 2008-2012

	LOW - YEAR: - #	2010	HIGH - YEAR: + #
Bouy J - Georgia Strait	1095 - 2009: -63	1159	1268 - 2011: +109
Bouy J - Puget Sound	344 - 2009: 22	322	325 - 2011: +3
Puget Sound - Georgia Strait	0 - 2009: +0	0	0 - 2011: +0
Total Change Bulk FV	-41		+112

CONTAINER TRANSIT NUMBER HIGH-LOW ANALYSIS FROM 2008-2012

	LOW - YEAR: - #	2010	HIGH - YEAR: + #
Bouy J - Georgia Strait	223 - 2009: -85	308	332 - 2011: +25
Bouy J - Puget Sound	812 - 2009: +46	766	807 - 2011: +41
Puget Sound - Georgia Strait	274 - 2009: +52	222	258 - 2011: +36
Total Change Container FV	+13		+102

OTHER CARGO TRANSIT NUMBER HIGH-LOW ANALYSIS FROM 2008-2012

	LOW - YEAR: - #	2010	HIGH - YEAR: + #
Bouy J - Georgia Strait	336 - 2009: -50	386	421 - 2011: +36
Bouy J - Puget Sound	280 - 2009: +28	252	255 - 2011: +3
Puget Sound - Georgia Strait	246 - 2009: +20	226	260 - 2011: +34
Total Change Other Cargo FV	-2		+73

Figure 109. A 5-year trend analysis of cargo focus vessel traffic flows based on 2008-2012 AIS crossing line count data provided in Figure 107. Note that only three graphs appear in the figure as vessels streams between two locations are equal in both directions.

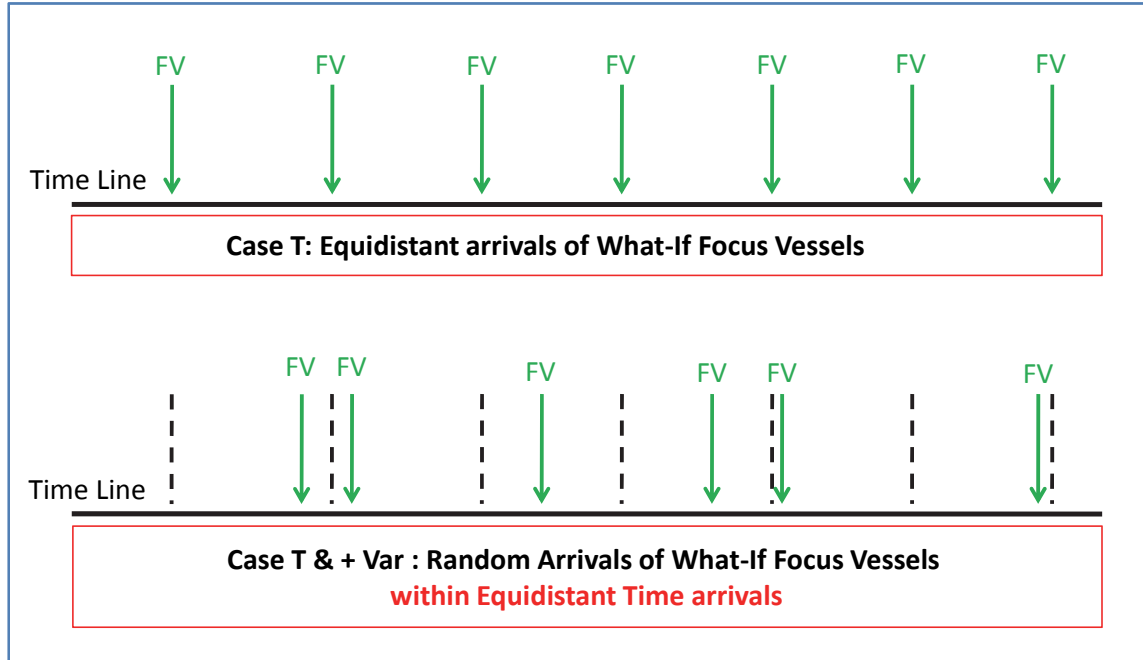

Figure 110. Equidistant arrivals of What-If focus vessels and modeling of random arrivals within equidistant time intervals to test effect of added variability in What-If focus vessel arrivals.

A distinct advantage of selecting equidistant arrivals for various What-If scenario's over random arrivals in equidistant time intervals in the VTRA 2010 What-If scenarios (Q), (R), (S) and (T) is that observed differences between scenario analyses in that case are solely the result of how the modeled Maritime Transportation System (MTS) responds to these added vessel arrivals and not the result of changes in timing of What-If Focus vessel arrival patterns from scenario to scenario (as would have been the case should the random approach within equidistant time intervals have been selected throughout the VTRA 2010 scenario analyses).

Bench marking the What-If Scenarios and the BM/Sensitivity Scenarios

Figure 111 depicts the summary analysis results of the bench mark/sensitivity scenarios enacted on the VTRA 2010 Base Case (P). The bench mark/sensitivity is evaluated for vessel time exposure, POTENTIAL accident frequency and POTENTIAL oil outflow. The delta change for each bench mark/sensitivity scenario is evaluated in terms of base case percentages and can thus be compared against the delta changes evaluated for the What-If Scenarios depicted in Figure 74. For completeness the 2010 Base Case is shown as a 0% delta change from itself in Figure 111.

Bench marking at vessel time exposure level

Observe from the left panel of Figure 111 that when compared to the traffic levels of the VTRA 2010 Base Case (P), the addition of about 142 tank focus vessels (P & HTFV) increases vessel time

P - RMM SCENARIO REFERENCE POINT				
	Vessel Time Exposure (VTE)	Oil Time Exposure (OTE)	Pot. Accident Frequency (PAF)	Pot. Oil Loss (POL)
P - Base Case	100%	100%	100%	100%

CASE P BENCHMARK (BM) & SENSITIVITY ANALYSIS	
P - BC & LOW TAN + CFV	Base Case with Tankers and Cargo Focus Vessels set at a low historical year
P - BC & LOW TAN	Base Case with Tankers set at a low historical year
P - BC & HIGH TAN	Base Case with Tankers set at a high historical year
P - BC & HIGH TAN + CFV	Base Case with Tankers and Cargo Focus Vessels set at a high historical year

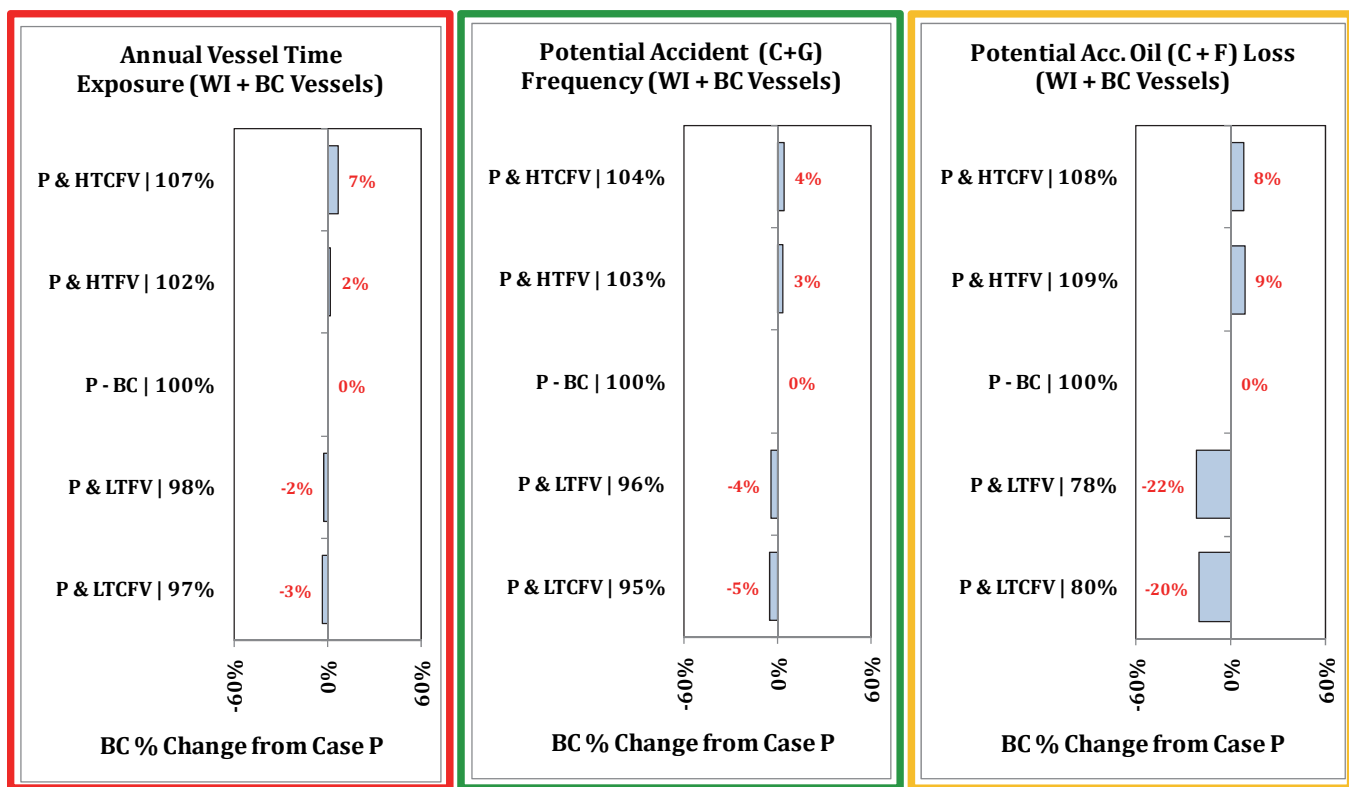

Figure 111. Summary Analysis results of BM/Sensitivity Scenario Analysis enacted on the base case (P).

exposure by a delta change of about (+2%), whereas the addition of 142 tank focus vessels and 287 cargo focus vessels (P & HTCFV) increases vessel time exposure by a delta change of (+7%). When comparing these delta changes against those observed for the What-If scenarios in the left panel of Figure 74, one observes that delta changes in vessel time exposure for the Delta Port What-if Scenario DP - 415 (+5%) and the Trans Mountain Pipeline expansion scenario KM-348 (+7%) are within the ball bark of the historical high scenario's P & HTFV and P & HTCFV delta changes. The vessel time exposure delta changes for the Gateway GW487 scenario (+13%) and

Combined What-If Scenario T (+24%) on the other hand are larger. In fact, the delta change for the Combined What-If Scenario T is about a multiplicative factor

$$(+24\%)/(+7\%) \approx 3$$

times more than the delta change in vessel time exposure for the historical high scenarios P & HTFV and P & HTCFV. Hence, it would be fair to say that increases in vessel time exposure under the GW-487 and Combined What-If (T) scenarios are significant as they are higher than the increases in vessel time exposure observed for the historical high scenarios P & HTFV and P & HTCFV.

Bench marking at POTENTIAL accident frequency level

One concludes from Figure 111 that the delta change of (+5%) in vessel time exposure by adding 287 cargo focus vessels on top of the added 142 tank focus vessels results only in a delta change of (+1%) in POTENTIAL accident frequency from P & HTFV, whereas the addition of the 142 tank focus vessels on their own results in a delta change of (+3%) in POTENTIAL accident frequency from the Base Case (P). Overall the P & HTCFV Scenario results in a delta change of (+4%) in POTENTIAL accident frequency from the Base Case (P).

Comparing the delta change in POTENTIAL accident frequency of (+4%) against the delta changes evaluated for the various What-If Scenarios in the middle panel of Figure 74 (+12%, +6% and +5%), one concludes that the VTRA 2010 analysis suggests that all three individual What-If scenarios result in higher delta changes in POTENTIAL accident frequency than the historical high scenarios P & HTFV and P & HTCFV. Therefore, these increases can be considered significant. In fact, the delta change for the Combined What-If Scenario (T) in POTENTIAL accident frequency (+18%) is about a multiplicative factor

$$(+18\%)/(+4\%) \approx 4$$

times more than the delta changes in POTENTIAL accident frequency for the historical high scenario P & HTCFV. In other words, if all three expansions scenario were to be in effect, the VTRA 2010 analysis results suggest that the delta change in POTENTIAL accident frequency from the 2010 Base Case (P) to be about a factor 4 higher than the delta change observed from the Base Case 2010 (P) year to the historical high scenario P & HTCFV.

Bench marking at POTENTIAL oil loss level

Finally, observe from Figure 111 that both the P & HTFV and P & HTCFV scenarios result both in a delta change of about (+9%) in POTENTIAL oil loss. Hence, this (+9%) increase is predominantly attributable to the addition of the 142 tank focus vessels to the VTRA 2010 Base Case (P).

Comparing the delta change in POTENTIAL oil loss of (+9%) against the delta change in POTENTIAL oil loss evaluated for the various What-If scenarios in the right panel of Figure 74

(+12%, +36%, +4%) one concludes that the VTRA 2010 analysis suggests that both the Gateway What-If expansion scenario and the Trans-Mountain Pipeline expansion scenario result in a higher delta change in POTENTIAL oil loss than the historical high scenarios P & HTFV and P & HTCFV and thus these delta changes can be considered significant. In fact, the delta change for the Combined What-If Scenario (T) in POTENTIAL oil loss is about a multiplicative factor

$$(+68\%)/(+9\%) \approx 7$$

times more than the delta changes in POTENTIAL oil loss for the historical high scenarios P & HTFV and P & HTCFV. In other words, if all three expansions scenario were to be in effect, the VTRA 2010 analysis results suggest that the delta change in POTENTIAL oil loss from the 2010 Base Case (P) to be about a factor 7 times higher than the delta change evaluated from the Base Case 2010 (P) year to historical high scenario's P & HTFV and P & HTCFV.

Bench marking the RMM Scenarios and the BM/Sensitivity Scenarios

Figure 111 depicts the summary analysis results of the bench mark/sensitivity scenarios enacted on the VTRA 2010 Base Case (P). The bench mark/sensitivity is evaluated for vessel time exposure, POTENTIAL accident frequency and POTENTIAL oil outflow. The delta change for each bench mark/sensitivity scenario is evaluated in terms of base case percentages and can thus be compared against the delta changes evaluated for the RMM Scenarios depicted in Figure 90, Figure 95 and Figure 98. For completeness the 2010 Base Case is shown as a 0% delta change from itself in Figure 111.

Bench marking at vessel time exposure level

Observe from the left panel of Figure 111 that the removal of about 191 tank focus vessels (P & LTFV) decreases vessel time exposure by a delta change of about (-2%) from the base case (P), whereas the removal of about 191 tank focus vessels and 30 cargo focus vessels (P & LTCFV) decreases vessel time exposure by a delta change of about (-3%). None of the RMM scenarios enacted on the Base Case P (left panel of Figure 90), however, result in a reduction of vessel time exposure. The RMM scenarios enacted on Case Q (Figure 95) do result in a reduction of vessel time exposure with delta changes of about (-4%) from the What-If Scenario Q – GW487 as a result of the removal of bunkering support in both RMM Scenarios Q – GW487& NB and Q – GW487 & NB & OH. Finally, observe that none of the RMM Scenario's enacted on Case T (Figure 93) results in a reduction of vessel time exposure from the Combined What-If scenario (T).¹⁹

¹⁹ The RMM scenario T & 6RMM's also includes removal of bunkering support for Gateway vessels, but its subsequent decrease in vessel time exposure are offset by vessel time exposure increases as a result of the other RMM scenario's included.

Bench marking at POTENTIAL accident frequency level

Observe from the middle panel of Figure 111 that the delta change of (-2%) in vessel time exposure in case of the P & LTFV scenario translates in a delta change of about (-5%) in POTENTIAL accident frequency for the P & LTFV and P & LTCFV scenarios. From a benchmarking perspective, observe from the middle panel in Figure 90 that the RMM scenario P-BC & CONT 17KNTS results in a similar delta change in POTENTIAL accident frequency of (-4%) as the removal of about 191 tankers from the Base Case (i.e. the P & LTFV scenario). In fact, one observes from Figure 90, Figure 95 and Figure 98 that with the exception of the RMM scenario T & EC and the RMM scenario T & OW ATB, all other RMM scenarios result in larger delta change reductions in POTENTIAL accident frequency (as evaluated as delta changes from Case P, from Case Q and from Case T, respectively) than the low historical traffic scenarios P & LTFV and P & LTCFV. These delta change reductions can thus be considered significant. In fact, in case of the combined T & 6RMM scenario one observes a delta change reduction of (-29%) from Case T in POTENTIAL accident frequency, which is about a multiplicative factor

$$(-29\%)/(-5\%) = 6$$

more risk reduction one would get in POTENTIAL accident frequency when cancelling 191 tank focus vessels and about 30 cargo focus vessels from the Base Case (P) (i.e. the P & LTCFV scenario).

In fact it is noteworthy, that under the T & 6RMM scenario we have for the delta change reduction in POTENTIAL accident frequency from the base case (P)

$$89\%-100\% = (-11\%),$$

whereas for the low historical scenarios P & LTFV and P & LTCFV we observe delta change reductions of (-4%) and (-5%) from the base case (P). In other words, the VTRA 2010 analysis results suggest that under the risk mitigation scenario T & 6RMM the delta change in POTENTIAL accident frequency is about a multiplicative factor

$$(-11\%)/(-4\%) \approx 3 \text{ and } (-11\%)/(-5\%) \approx 2$$

LOWER than the delta change in the POTENTIAL accident frequency observed for the historical low scenarios P & LTFV and P & LTCFV!

Bench marking at POTENTIAL oil loss level

Observe from the right panel of Figure 111 that reductions in POTENTIAL accident frequency in cases P & LTFV and P & LTCFV lead to delta changes of (-22%) and (-20%) in POTENTIAL oil loss, respectively. Thus these reductions in POTENTIAL oil loss primarily result from the removal of 191 tank focus vessels. The difference in the relative larger delta change reduction of POTENTIAL oil loss when removing 191 tankers (-22%) compared to the delta change increase (+9%) when adding 142 tankers to the VTRA 2010 base case is explained by canceled tank focus vessels

FINAL REPORT: VTRA 2010

following different route patterns than the fictitious tank focus vessels that were added to the VTRA 2010 Base Case for the bench mark/sensitivity analysis purposes.

From a benchmarking perspective, note that the removal of about 191 tank focus vessels and 30 cargo focus vessels from the Base Case (P & LTCFV) results in a similar delta change reduction in POTENTIAL oil loss (-22%) as the delta change reduction (-24%) evaluated for RMM scenario T-GW-KM-DP & EH²⁰ from the combined What-If scenario (T). In fact, the RMM scenario T & 6RMM's results in a delta change of (-44%) reduction in POTENTIAL oil loss, with translates to a multiplicative factor

$$(-44\%)/(-22\%) = 2.$$

Hence, the VTRA 2010 analysis results suggest that the risk reduction one would get in case of the T & 6RMM's is double the risk reduction one would get from removing 191 tank focus vessels and 30 cargo focus vessels from the Base Case (P).

Other benchmarking comparisons can be made by comparing Figure 111 to Figure 90, Figure 95 and Figure 98.

By waterway zone analysis results of BM/Sensitivity scenarios enacted on base case (P)

Figure 112 provides a by waterway zone comparison of changes in terms of POTENTIAL accident frequency and POTENTIAL oil outflow for the high BM/sensitivity analysis scenario P & HTCFV²¹ and low BM/Sensitivity analysis scenario P & LTCFV²². One observes from the top left panel in Figure 112 that under the P & HTCFV Scenario the largest absolute increase (+1.8%) in POTENTIAL accident frequency is observed in the Guemes waterway zone. The largest relative waterway multiplicative factor ($\times 1.28$), however, is observed for the Buoy J waterway zone. From the bottom left panel in Figure 112 it follows that under the P & LTCFV Scenario the largest absolute reduction (-1.1%) in POTENTIAL accident frequency is observed in the Guemes and Saddlebag waterway zones. This translates for the Saddlebag waterway zone into the smallest relative waterway multiplicative factor ($\times 0.62$). Hence, 38% of the POTENTIAL accident frequency in the Base Case (P) in the Saddlebag waterway zone is removed through the removal of 191 tank focus vessels and 30 cargo focus vessels.

One observes from the top right panel in Figure 112 that under the P & HTCFV Scenario the largest absolute increase (+4.2%) in POTENTIAL oil loss is observed in the Guemes waterway zone. The largest relative waterway multiplicative factor ($\times 1.62$), however, is observed for the Buoy J waterway zone. From the bottom right panel in Figure 112 it follows that under the P & LTCFV Scenario the largest absolute reduction (-6.7%) in POTENTIAL oil loss is observed for the

²⁰ Case T & EH assumes the availability of +1 escort for all focus vessels in the green area depicted in Figure 89.

²¹ That is, with the addition of 142 tank focus vessels and 287 cargo focus vessels on top of the base case (P)

²² That is, with the removal of 191 tank focus vessels and 30 cargo focus vessels from the base case (P)

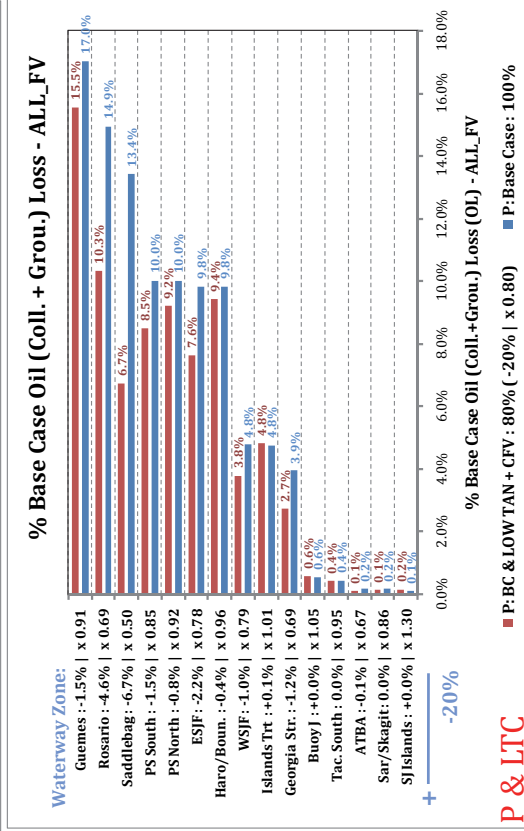
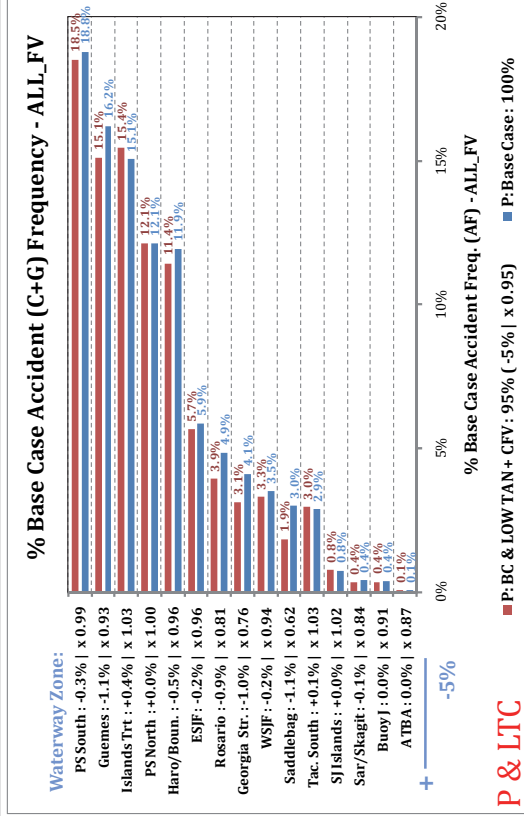
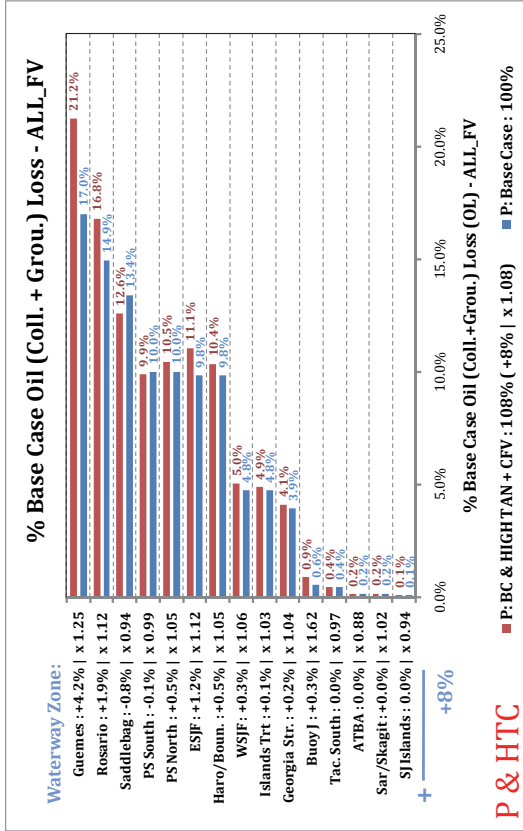
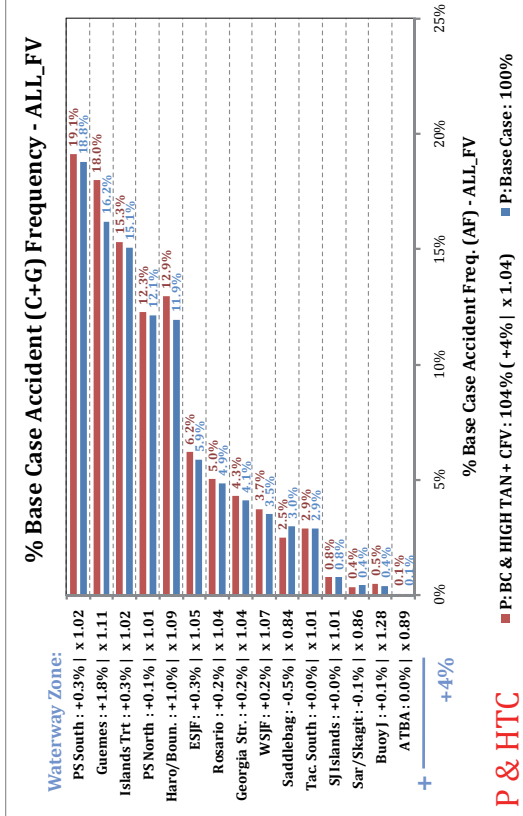

Figure 112. Waterway zone POTENTIAL accident frequency, and oil outflow results comparison of high and low Scenarios enacted on base case (P). For a detailed explanation of output format see Page 97.

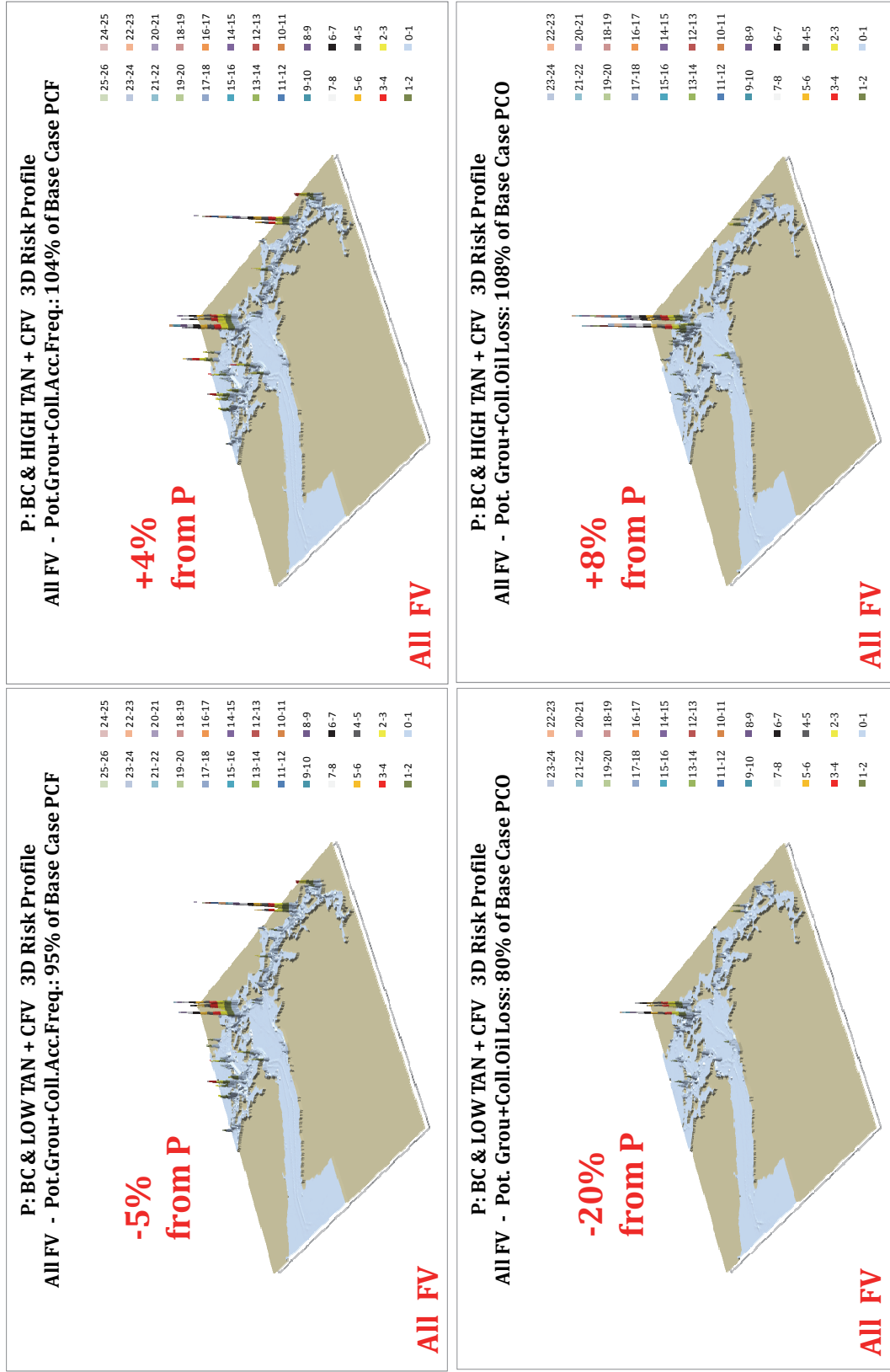

Figure 113. Geographic profiles of POTENTIAL accident frequency and oil outflow for high and low scenarios enacted on base case (P)

Saddlebag waterway zone. This translates for the Saddlebag waterway zone into the smallest relative waterway multiplicative factor ($\times 0.50$). Hence, 50% of the POTENTIAL oil loss in the Base Case (P) in the Saddlebag waterway zone is removed through the removal of 191 tank focus vessels and 30 cargo focus vessels from the base case.

Summary of BM/Sensitivity Scenarios Results enacted on combined What-If scenario (T)

Figure 114 depicts the summary analysis results for the bench mark/sensitivity scenarios enacted on the Combined What-If Scenario (T). The sensitivity is evaluated in terms of vessel time exposure, accident frequency and oil outflow. The delta change for each bench mark/sensitivity scenario is evaluated in terms of base case percentages from Case T and for completeness the Combined What-If Scenario (T) is shown as a 0% delta change from itself.

Observe from Figure 114 that the addition of about 142 tank focus vessels in terms of base case percentages now results in a delta change of (+3%) in vessel time exposure (T & HTFV), whereas the addition of 142 tank focus vessels and 289 cargo focus vessels results in a delta change of (+6%). Next, one concludes from Figure 114 and Figure 111 that the 3% additional increase of vessel time exposure by adding 142 tank focus vessels now (T & HTFV) results in a delta change of (+6%) in POTENTIAL accident frequency whereas when added to the Base Case (P) a delta change of (+3%) (P & HTFV) was evaluated. Observe from Figure 114 and Figure 111 that the addition of the 142 tank focus vessels and 289 cargo focus vessels to the base case (P & HTCFV) resulted in a delta change of (+8%) in POTENTIAL oil outflow, but when added to the combined What-If Scenario (T) results in a delta change of (+17%). On the other hand, while the removal of 191 tank focus vessels and 30 cargo focus vessel resulted in Case P & LTCFV in a delta change of (-20%) in POTENTIAL oil outflow, the same removal of tank focus vessels and cargo focus vessel from the Combined What-If scenario results in a delta change reduction of (-27%). Hence, overall one observes a larger sensitivity of analyses results with respect to traffic level changes in the Combined What-If Scenario (T) than in the base case (P). We attribute this larger sensitivity to Case T experiencing a larger amount of overall focus vessel traffic than the base case (P)²³.

Finally, one observes from Figure 114 that the added variability of What-If focus vessel arrivals in Case T & Var results in a lower POTENTIAL accident frequency (-3%) and a lower POTENTIAL oil outflow (-10%) than observed in the Combined What-If Scenario Case T. Please note that the delta change in vessel time exposure for the T & Var scenario equals (-1%) indicating a larger delay in focus vessel transits than when assuming equidistant traffic arrivals (see Figure 110).

²³ The vessel time exposure (VTE) in the Combined What-If Scenario (T) is about 24% higher than that of the 2010 base case (P).

CASE T - REFERENCE POINT				
	Vessel Time Exposure (VTE)	Oil Time Exposure (OTE)	Pot. Accident Frequency (PAF)	Pot. Oil Loss (POL)
T - GW - KM - DP	+25% 125%	+59% 159%	+18% 118%	+68% 168%

CASE T BENCHMARK (BM) & SENSITIVITY ANALYSIS	
T - LOW TAN + CFV	Case T with Tankers and Cargo Focus Vessels set at a low historical year
T - LOW TAN	Case T with Tankers set at a low historical year
T - GW - KM - DP & VAR	Case T with additional variability in timing of What-If Focus Vessel arrivals
T - HIGH TAN	Case T with Tankers set at a high historical year
T - HIGH TAN + CFV	Case T with Tankers and Cargo Focus Vessels set at a high historical year

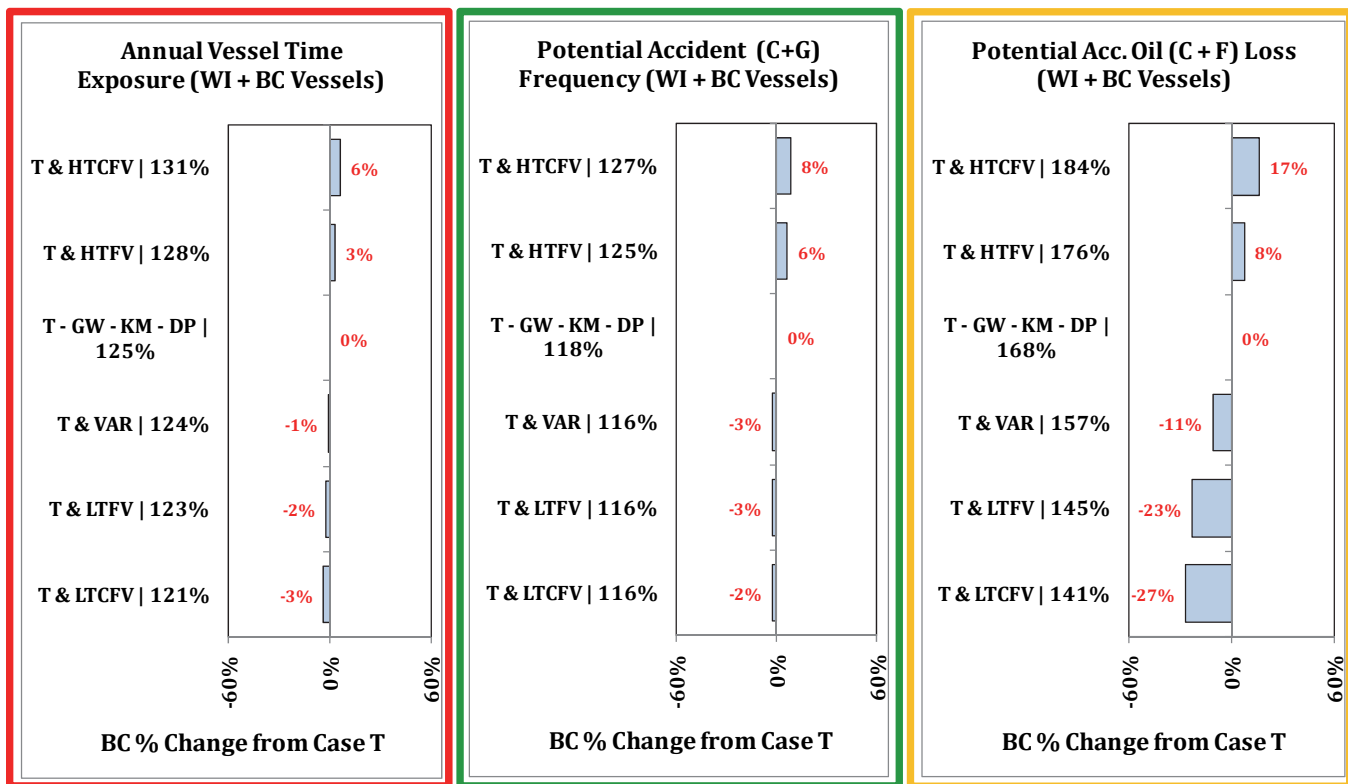

Figure 114. Summary Analysis results of BM/Sensitivity Analysis enacted on the Combined What-If Case (T).

By waterway zone analysis results of BM/Sensitivity scenarios enacted on combined case (T)

Figure 115 provides a by waterway zone comparison of changes in terms of POTENTIAL accident frequency and POTENTIAL oil loss for the high BM/sensitivity analysis scenario T & HTCFV²⁴ and

²⁴ That is, with the addition of 142 tank focus vessels and 287 cargo focus vessels on top of the Combined What-If Scenario (T)

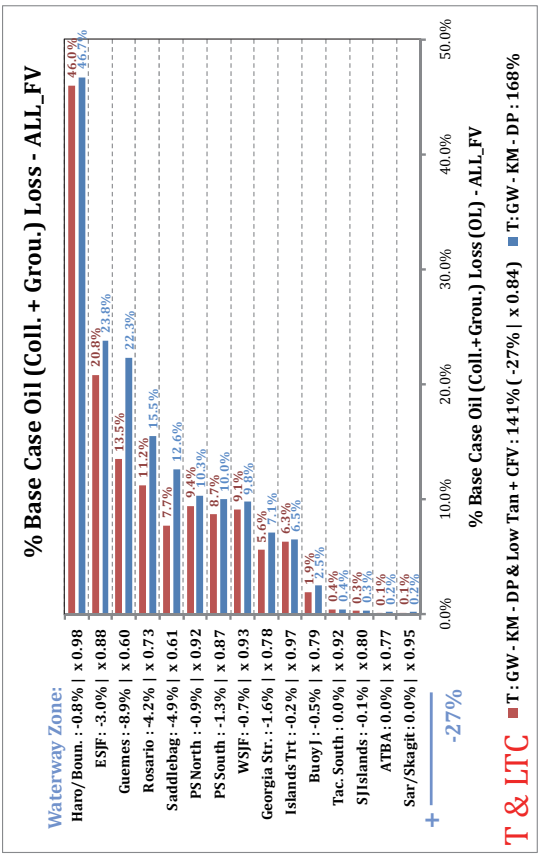
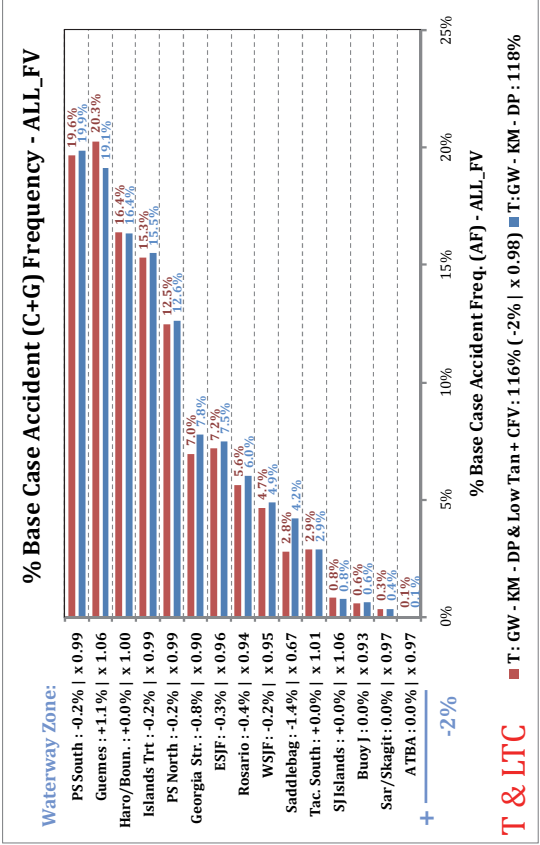
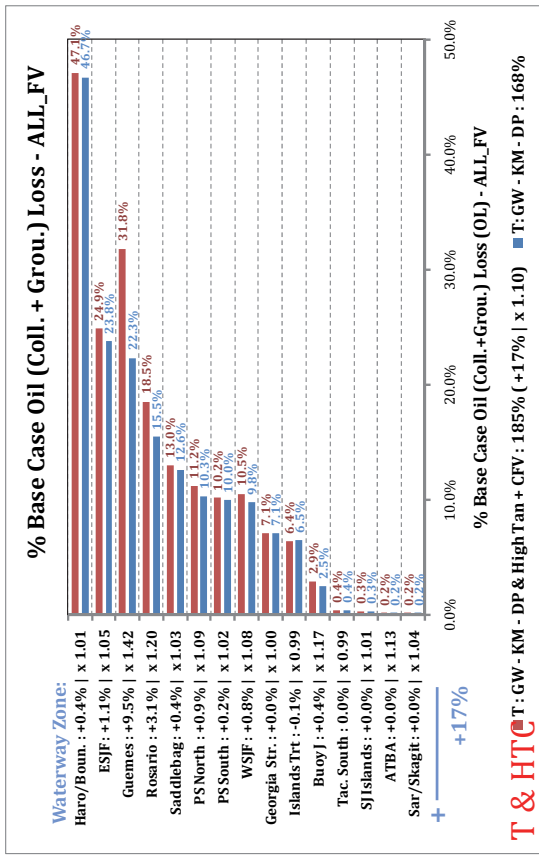
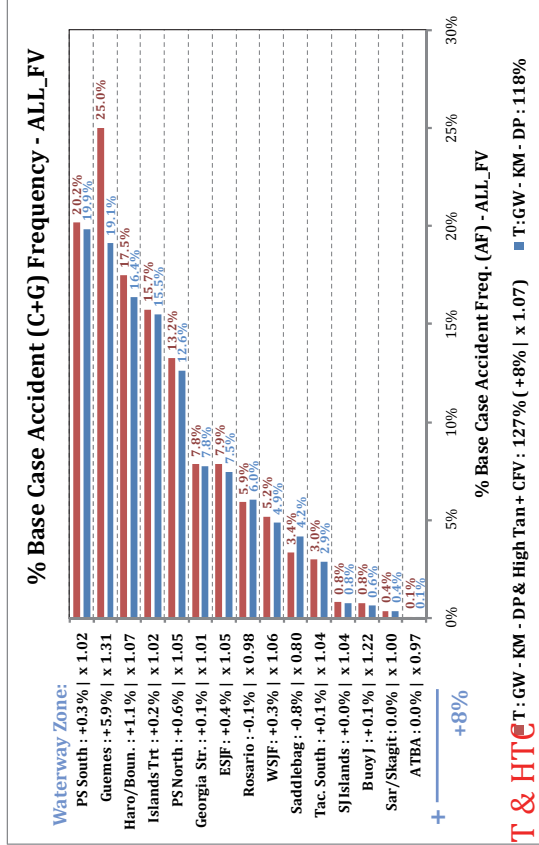

Figure 115. Waterway zone POTENTIAL accident frequency, and oil outflow results comparison of high and low Scenarios enacted on Combine Case (T). For a detailed explanation of output format see Page 97.

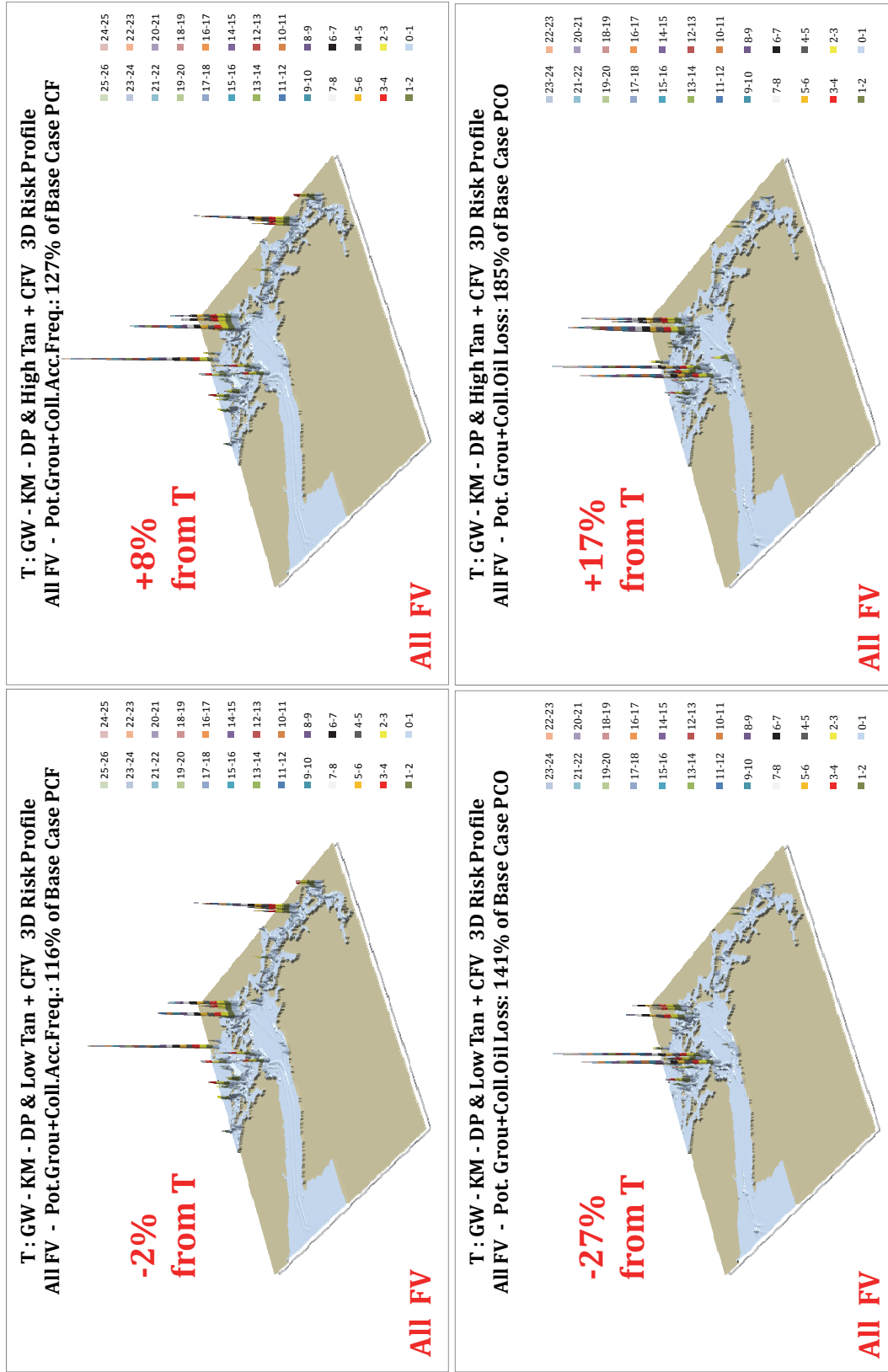

Figure 116. Geographic profiles of POTENTIAL accident frequency and oil outflow for high and low Scenarios enacted on combined case (T)

low BM/Sensitivity analysis scenario T & LTCFV²⁵. One observes from the top left panel in Figure 115 that under the T & HTCFV Scenario the largest absolute increase (+5.9%) in POTENTIAL accident frequency is observed in the Guemes waterway zone compared to the (+1.8%) in case of the P & HTCFV Scenario (see top left panel in Figure 112). This translated here for the Guemes waterway zone into the largest relative waterway multiplicative factor ($\times 1.31$). From the bottom left panel in Figure 112 it follows that under T & LTCFV the largest absolute reduction (-1.4%) in POTENTIAL accident frequency is observed in the Saddlebag waterway zone. This translates for the Saddlebag waterway zone smallest relative waterway multiplicative factor ($\times 0.67$). Hence, 33% of the POTENTIAL accident frequency in the Combined What-If Scenario T in the Saddlebag waterway zone is removed through the removal of 191 tank focus vessels and 30 cargo focus vessels from the Combined What-If scenario (T).

One observes from the top right panel in Figure 115 that under T & HTCFV the largest absolute increase (+9.5%) in POTENTIAL oil loss is observed in the Guemes waterway zone compared to the (+4.2%) in case P & HTCFV (see top right panel in Figure 112). From the bottom right panel in Figure 115 it follows that under P & LTCFV the largest absolute reduction (-8.9%) in POTENTIAL oil outflow is observed now in the Guemes waterway zone. This translates for the Guemes waterway zone into the smallest relative waterway multiplicative factor ($\times 0.60$). Hence, 40% of the POTENTIAL accident frequency in the Combined What-If Scenario T in the Guemes waterway zone is removed through the removal of 191 tank focus vessels and 30 cargo focus vessels.

²⁵ That is, with the removal of 191 tank focus vessels and 30 cargo focus vessels from the Combined What-If Scenario (T)

10. CONCLUSIONS AND RECOMMENDATIONS

A detailed consideration of traffic levels is particularly important as one moves forward to considering risk and POTENTIAL changes in risk from the commercial projects being proposed for the northern Puget Sound and southern British Columbia over the next decade or so. To put it simply, keeping everything else the same, when traffic increases risk increases, unless mitigated. Further, there is no guarantee that risk increases due to traffic increases can be fully mitigated.

The starting point for the 2010 VTRA analysis is the updated 2005 VTRA model with 2010 VTOSS data. The update of the 2005 VTRA model to using 2010 VTOSS data and the validation of this update with AIS 2010 data, is fully described in detail in [19] and for completeness also summarized in this report. To distinguish the study described herein from the previous 2005 VTRA study conducted from 2006-2008 it is labeled the 2010 VTRA or VTRA 2010.

In the VTRA 2010 study, the VTRA 2010 Steering Committee chose to model only the traffic level impacts of planned expansion and construction projects that were in advanced stages of a permitting process. Each planned project forms a What-If scenario and What-If vessels are added to a maritime simulation of the 2010 Base Case year (Case P). Four What-If scenarios were modeled in the study:

- (1) The Gateway bulk carrier terminal (Q)
- (2) The Trans-Mountain pipeline expansion (R)
- (3) The combination of proposed changes at Delta Port (S)
- (4) All three of above scenarios operating at the same time (T)

Following What-If scenario analysis utilizing the VTRA 2010 model, 11 Risk Mitigation Measure (RMM) Scenarios were implemented on top of the VTRA 2010 model in an attempt to mitigate POTENTIAL increases in vessel time exposure, accident frequency and oil loss as evaluated by the VTRA 2010 What-If scenario analyses. Four RMM scenarios were enacted on the 2010 base case year (P), 2 were enacted on the Gateway What-If Scenario (Q) and 5 were enacted on the Combined What-If scenario (T). RMM decisions, however, are not limited to the 11 RMM Scenarios investigated during this study. Moreover, 8 sensitivity analysis scenarios were designed on top of the VTRA 2010 model to evaluate sensitivity of the VTRA 2010 model with respect to historical observed traffic levels. Since the sensitivity analysis scenarios are based on the selection of high and low historical traffic years these analysis scenarios can also serve as bench marks for the What-If scenario and RMM scenario analyses conducted using the VTRA 2010 model.

Following the bench marking/sensitivity analysis it was concluded that POTENTIAL delta changes increases in risk from the base case 2010 year for the What-If Scenario analyses exceed delta changes in risk evaluated for the high-year bench mark/sensitivity scenario analysis. It is therefore concluded that were any of the three What-If Scenario's to come into effect, or a

FINAL REPORT: VTRA 2010

combination thereof, that POTENTIAL delta changes in risk be deemed significant changes from the base case 2010 year evaluated risk levels. Hence, were any of the three What-If scenarios to come into effect, or any combination thereof, it would only be prudent to consider the implementation of one or more risk mitigation measures to counter those POTENTIAL risk increases.

The challenge of risk management is for it to be location specific, taking into consideration the type and location of traffic and how it changes as a result of proposed traffic increases. The proposed RMM scenarios evaluated herein were in part informed by evaluated changes in risk for the four What-If Scenarios. Comparing evaluated delta change risk reductions for the RMM scenario using the VTRA 2010 model, it was concluded that for 9 out of the 11 RMM scenario's delta change reductions were larger than the delta change reductions evaluated for the low year bench mark/sensitivity scenarios. Hence, it is concluded that for 9 out of these 11 RMM scenarios these risk reductions be deemed significant and be considered POTENTIAL risk mitigation measures for implementation should any of the three What-If Scenario's, or any combination thereof, to come into effect.

One must realize that risk does not necessarily disappear when mitigated locally, but tends to migrate as evidenced by some waterway zones experiencing increases in risk when other waterway zones are targeted for risk reductions. This is in large part a result of a maritime transportation system being a dynamic system, where a small traffic perturbation can precipitate traffic behavior changes in the future. Such migrations are preferably avoided in a sound risk management strategy, but some risk migration may be inevitable. To still achieve risk reduction across the VTRA study area, we believe that the question "which risk mitigation measure should one implement?" is not the right question to ask, but rather one should ask oneself "which portfolio of risk mitigation measures should one implement". A trial 6 RMM portfolio scenario analysis was conducted utilizing the VTRA 2010 model which resulted in risk reduction across virtually all the various waterway zones considered in the VTRA study area. Most importantly, evaluated POTENTIAL accident frequencies after the implementation of the trial RMM portfolio on top of the Combined What-If Scenario (T), that assumes all three expansion scenario are in effect simultaneously, were lower than evaluated Base Case (P) POTENTIAL accident frequencies. Evaluated POTENTIAL oil losses for the Combined What-If Scenario (T), on the other hand, were still evaluated at a higher level than the Base Case 2010 year. This leads us to the conclusion that while evaluated POTENTIAL risk increases as a result of the What-If Scenarios be deemed significant, we do believe that most of those risk increases can be mitigated utilizing a well designed RMM portfolio.

In testament to the Puget Sound Harbor Safety Committee's stated objective of instilling a safety culture within the Puget Sound maritime community, 4 out of the 11 suggested RMM scenario's involved risk mitigation measures that are currently under consideration or have been partially

implemented. The evaluation of these RMM Scenarios in the VTRA 2010 model was enacted on the 2010 Base Case year. Subsequent analyses evaluated delta change reductions in risk for these RMM scenarios that exceed the delta change reduction in risk evaluated for the historical low year bench mark/sensitivity analysis scenario. Hence, even if none of the three individual What-If scenarios come in effect, it is recommended that these risk mitigation measures be considered for across the board implementation in the VTRA study area.

In light of the observations in this VTRA 2010 study, while considering a longer-term view of risk management in the VTRA study area, we close with the observation that there is a serious need for an electronic data source that is cross-boundary (US and Canadian waters) where the vessel type is consistently defined and verified beyond cargo focus vessel or tank focus vessel classifications. VTOSS and AIS are such cross-boundary data sources and could serve this purpose. However without currently possessing a common and consistently recorded vessel identifier or vessel type classification, VTOSS and AIS unfortunately still required vetting at the individual vessel level for the purpose of the analysis presented in this report. Moreover, with the same eye towards risk management analysis it would be equally beneficial if such datasets capture cargo or at a minimum cargo levels (laden, unladen, 50% laden, etc.) and a cargo type. In particular, we would like to specifically call out the need for the electronic recording at a much greater consistency of the barge type and cargo content of tug-tows. Not only would studies like these benefit from the availability of such a data source, but the immediacy of having such information available could also benefit first responders responding to a spill scenario both from a response and a safety to the first responder perspective.

THIS PAGE IS LEFT
INTENTIONALLY BLANK

References

- [1] George J. Busenberg (1999). "Collaborative and adversarial analysis in environmental policy", *Policy Sciences*, Vol. 32, pp. 1-11.
- [2] J. R. van Dorp and J. R.W. Merrick (2009). "On a risk management analysis of oil spill risk using maritime transportation system simulation", *Annals of Operations Research*, published online before print December 12, 2010, DOI: 10.1007/s10479-009-0678-1. (<http://www.springerlink.com/content/w168111018754401/>)
- [3] G. van de Wiel and J. R. van Dorp (2009). "An oil outflow model for tanker collisions and groundings", *Annals of Operations Research*, published online before print November 25, 2010, DOI: 10.1007/s10479-009-0674-5. (<http://www.springerlink.com/content/d7432xmg431v42q7/>)
- [4] National Research Council (1998), Review of Prince William Sound Risk Assessment. Review of the Prince William Sound, Alaska, Risk Assessment Study Committee on Risk Assessment and Management of Marine Systems, Marine Board, ISBN: 0-309-55835-2, 78 pages.
- [5] J.R.W. Merrick, J. R. van Dorp, T. Mazzuchi, J. Harrald, J. Spahn and M. Grabowski (2002). "The Prince William Sound Risk Assessment". *Interfaces*, Vol. 32 (6): pp.25-40.
- [6] J.R. van Dorp J.R.W. Merrick , J.R. Harrald, T.A. Mazzuchi, M. Grabowski, and J.E Spahn (2000). "A Systems approach to managing oil transportation risk in Prince William Sound", *Systems Engineering*, Vol 3: pp. 128-142.
- [7] M. Grabowski, J.R.W. Merrick , J.R. Harrald, T.A. Mazzuchi, and J.R. van Dorp (2000). "Risk Modeling in Distributed, Large Scale Systems", *IEEE Transactions on Systems, Man, Cybernetics – PART A: Systems and Humans*, Vol. 30 (6): pp. 651-660.
- [8] J.R. Harrald, T.A. Mazzuchi, J. E. Spahn, J.R. van Dorp J.R.W. Merrick, S. Shrestha, M. Grabowski (1998). "Using System Simulation to Model the Impact of Human Error in a Maritime Risk Assessment". *Safety Science*, Vol. 30, pp. 235-247.
- [9] J.R. van Dorp J.R.W. Merrick , J.R. Harrald, T.A. Mazzuchi, and M. Grabowski (2001). "A Risk Management procedure for the Washington State Ferries", *Journal of Risk Analysis*, Vol. 21 (1): pp. 127-142.
- [10] J.R.W. Merrick, J.R. van Dorp, J.P. Blackford, G.L. Shaw, T.A. Mazzuchi and J.R. Harrald (2003). "A Traffic Density Analysis of Proposed Ferry Service Expansion in San Francisco Bay Using a Maritime Simulation Model", *Reliability Engineering and System Safety*, Vol. 81 (2): pp. 119-132.

- [11] J.R. van Dorp, J.R.W. Merrick, J.R. Harrald, M. Gabowksi (2008) "Assessment of Oil Spill Risk due to Potential Increased Vessel Traffic at Cherry Point, Washington " Final Report – Completed August 2008.
http://www.seas.gwu.edu/~dorpjr/tab4/publications_technical.html
- [12] J.R. van Dorp, J.R.W. Merrick, J.R. Harrald, M. Gabowksi (2009), "VTRA Final Report Addendum: A response to 23 comments from the Corps", completed January 2009.
http://www.seas.gwu.edu/~dorpjr/tab4/publications_technical.html
- [13] J.R. van Dorp, J.R.W. Merrick (2009), "A Response to Seven Additional Questions Related to the VTRA Project", completed May, 2009.
http://www.seas.gwu.edu/~dorpjr/tab4/publications_technical.html
- [14] P. Szwed, J. Rene van Dorp, J.R.W.Merrick, T.A. Mazzuchi and A. Singh (2006). "A Bayesian Paired Comparison Approach for Relative Accident Probability Assessment with Covariate Information", *European Journal of Operations Research*, Vol. 169 (1), pp. 157-177.
- [15] National Research Council (2001). Environmental Performance of Tanker Designs in Collision and Grounding, Special Report 259, Marine Board, Transportation Research Board, The National Academies.
- [16] Merrick, J. R. W. and J. R. van Dorp (2006). "Speaking the Truth in Maritime Risk Assessment". *Risk Analysis*, Vol. 26 (1), pp. 223 - 237.
- [17] J.R.W.Merrick, J. Rene van Dorp, V. Dinesh (2004). "Assessing Uncertainty in Simulation Based Maritime Risk Assessment". *Risk Analysis*, Vo. 25 (3), pp. 731-743.
- [18] J.R van Dorp and S. Kotz (2003). "Generalized Trapezoidal Distributions". *Metrika*, Vol 58, Issue 1, pp. 85-97.
- [19] J.R. van Dorp and J.R.W. Merrick (2013). Vessel Traffic Risk Assessment(VTRA): Updating the 2005 VTRA GW/VCU MTS Simulation Model from VTOSS 2005 to VTOSS 2010 data, Final report submitted to the Makah Tribal Council, April 2013,
http://www.seas.gwu.edu/~dorpjr/VTRA/Makah/Final_Report/MAKAH_Final_Report_20041013.pdf

Appendix: Glossary and List of Acronyms

- Allision–The collision of a vessel with its intended docking berth.
- AIS – Automatic Identification System
- ATB – Articulated Tug Barge
- Ecology – The Washington Department of Ecology’s Spill Prevention, Preparedness and Response Program which is the primary state organization with authority and accountability for managing oil and hazardous material spill risk state-wide. Ecology is assisting PSP in conducting the VTRA with its expertise and experience.
- EPA – Environmental Protection Agency.
- MTS – Maritime Transportation System.
- FV – Focus Vessel.
- ITB – Integrated Tug Barge.
- IV – Interacting Vessel.
- MXPS – Marine Exchange Puget Sound.
- NGO – Non-Governmental Organization.
- NPO – Non-Persistent Oil
- Study Area – The Washington waters of Puget Sound east of Cape Flattery, north of Admiralty Inlet and west of Deception Pass, and their approaches.
- GW – George Washington University is the prime subgrant awardee.
- VCU – Virginia Commonwealth University is a sub-awardee to GW.
- GW/VCU – The technical team composed of GW and VCU.
- PO – Persistent Oil.
- PSP – The Puget Sound Partnership is the Washington state agency responsible for developing a Puget Sound Action Agenda, convening a Cross Partnership Oil Spill Work Group and for coordinating work to restore and protect Puget Sound.
- PSHSC – The Puget Sound Harbor Safety Committee.
- VTRA 2010 Steering Committee – A steering committee of stakeholders advising the Puget Sound Partnership and GW/VCU over the course of this study.
- QAPP – Quality Assurance Project Plan
- USCG – US Coast Guard Sector Seattle, District 13.
- VTOSS – Vessel Traffic Operational Support System
- VTRA – Vessel Traffic Risk Assessment
- VTS – Vessel Traffic Service is the real-time marine traffic monitoring system used by the USCG, similar to air traffic control for aircraft.

FINAL REPORT: VTRA 2010**List of other VTRA meeting attendees**

Individuals who attended one or more meetings (alphabetized by organization)

1. Scott McCreery (BP)
2. John Robinson (Cardno-Entrix)
3. Tom Ehrlichman, Barbara Dykes (Center for Salish Community Strategies)
4. Kevin Champion (Deep Green Wilderness)
5. John Kaltenstein (Friends of the Earth)
6. Sam Olson (Friends of the San Juans)
7. David Gray, Eleanor K. N. Kirtley (Glosten Associates)
8. Michael Davies, Bikramjit Kanjilal and Kris Faucett (Kinder Morgan)
9. Gordon Maclean (Marine Exchange)
10. Michael O'Leary (National Wildlife Federation)
11. George Galasso (Olympic Coast National Marine Sanctuary)
12. Dave and Karen Anderson (Orca Network)
13. Arif Ghouse (Port of Seattle)
14. Andreas Udbye (Portland State University)
15. Daryl Williams, Preston Hardison (Tulalip Tribe)
16. JD Ross Leahy (University of Washington -SMEA)
17. Justin Willig (University of New Hampshire graduate)
18. Marc Ashley (USCG Sector Seattle)
19. Todd Malloy